



**U.S. Army Corps
of Engineers**

**Galveston District
Southwestern Division**

Appendix D

**Engineering Design, Cost Estimates,
and Cost Risk Analysis
for the
Coastal Texas Protection and Restoration
Feasibility Study**

October 2020

CONTENTS

LIST OF TABLES AND FIGURES.....	VII
FIGURES.....	VII
TABLES.....	X
LIST OF ACRONYMS.....	XIII
1.0 GENERAL.....	1-1
1.1 PURPOSE AND CONTEXT.....	1-1
1.1.1 Scope of Effort.....	1-1
1.2 PROJECT OVERVIEW.....	1-2
1.3 ORGANIZATION OF THE REPORT.....	1-4
1.4 PROJECT COORDINATION.....	1-5
1.5 PROJECT DATUM.....	1-5
1.6 DESIGN CONSIDERATIONS.....	1-5
1.7 DESCRIPTION OF EXISTING CSRM FEATURES RELEVANT TO THE PROJECT.....	1-7
1.7.1 Texas City Hurricane Flood Protection Project (TCHFFP).....	1-7
1.7.2 Lynchburg Pump Station.....	1-8
1.7.3 Galveston Seawall.....	1-8
1.8 DATA MANGEMENT PLAN.....	1-9
2.0 HYDROLOGY AND HYDRAULICS.....	2-1
2.1 INTRODUCTION.....	2-1
2.2 EXISTING DATA.....	2-2
2.2.1 Topographic, Bathymetric, and Survey Data.....	2-2
2.2.2 FEMA Data.....	2-2
2.2.3 Tropical Cyclones and Flood Records.....	2-3
2.3 PHYSICAL OCEANOGRAPHY.....	2-5
2.3.1 Tides.....	2-5
2.3.2 Currents, Circulation, and Salinity.....	2-7
2.3.3 Historical Shoreline Changes.....	2-10
2.4 TIDAL DATUM AND RELATIVE SEA LEVEL CHANGE SCENARIO.....	2-12
2.4.1 Relative Sea Level Change (RSLC).....	2-12
2.4.2 Historical RSLC.....	2-13
2.4.3 Relative Sea Level Rise Scenario for Present and Future Conditions.....	2-17
2.5 COASTAL STORM MODEL SIMULATIONS.....	2-22
2.5.1 Example Model Results: Without Project.....	2-23
2.5.2 Example Model Results: With-Project.....	2-24
2.6 DISCUSSION OF STORM SURGE WITH PROJECT ALTERNATIVE ALIGNMENTS.....	2-27
2.6.1 With Project Storm Surge Reduction (Individual Storm).....	2-27
2.6.2 Probabilistic Modeling of Storm Surge (Point Hazard Curves).....	2-29
2.6.3 Probabilistic Modeling of Storm Surge (Hazard Surface).....	2-33
2.6.4 With Project Still Water Level: Discussion on Inducements.....	2-34

2.7	DESIGN GUIDANCE.....	2-36
2.7.1	Crest Elevation for the Galveston Ring Barrier System (GRBS)	2-37
2.7.2	Crest Elevation for the Clear Lake & Dickinson Bay Closure System	2-41
2.7.3	Crest Elevation for the Bolivar Road Surge Barrier System and Sea Wall Modification	2-43
2.7.4	Pump Sizing: Galveston Ring Barrier System (GRBS).....	2-45
2.7.5	Pump Station at Clear Lake Crossing.....	2-47
2.7.6	Pump Station at Dickinson Bay Crossing.....	2-49
2.8	SALINITY, VELOCITY AND ENVIRONMENTAL MODELING	2-51
2.8.1	Input Conditions	2-53
2.8.2	Freshwater Inflow.....	2-53
2.8.3	Hydrodynamic Model Results	2-55
2.8.4	Larval Transport.....	2-62
2.8.5	Environmental Modeling Discussion	2-65
3.0	GEOTECHNICAL.....	3-1
3.1	SCOPE OF WORK.....	3-1
3.2	DOMAIN.....	3-1
3.3	DESIGN CRITERIA	3-6
3.3.1	Selection of Design Criteria	3-6
3.3.2	Historical Documentation and Input Data	3-6
3.3.3	Reference Documents.....	3-6
3.3.4	Regional Geology.....	3-7
3.3.5	Engineering Software	3-9
3.4	GEOTECHNICAL EVALUATION.....	3-9
3.4.1	Subsurface Conditions for CSRSM System Features	3-9
3.4.2	Foundation Conditions – Ecosystem Restoration (ER)	3-14
3.4.3	Analysis Soil Profiles and Soil Parameters	3-14
3.4.4	Feasibility Level Geotechnical Design Analysis Results and Assumptions for CSRSM Features.....	3-18
3.4.5	Feasibility Level Geotechnical Design Analysis Results and Assumptions for Channel Widening and Anchorage Area Improvement	3-21
3.4.6	Feasibility Level Geotechnical Design Analysis Results and Assumptions for Ecosystem Restoration Measures.....	3-22
3.5	BORROW SOURCES.....	3-24
3.6	RECOMMENDATIONS FOR GEOTECHNICAL DESIGNERS DURING PED PHASE.....	3-25
4.0	CIVIL DESIGN AND FOOTPRINT.....	4-1
4.1	COASTAL STORM RISK MANAGEMENT FEATURES	4-1
4.1.1	Bolivar Peninsula and West Galveston Beach and Dune System.....	4-1
4.1.2	Dune Vegetation.....	4-3
4.1.3	Sand Fencing	4-3
4.1.4	Dune Walkovers	4-4
4.1.5	Vehicle Access Ramps	4-5
4.2	BOLIVAR ROAD CROSSING.....	4-7
4.2.1	Channel Widening	4-8
4.2.2	Aids to Navigation.....	4-8

4.2.3	Anchorage Area Impacts	4-8
4.3	GALVESTON ISLAND CONTROL/VISITOR CENTER	4-11
4.4	GALVESTON ISLAND RING BARRIER SYSTEM	4-12
4.4.1	Seawall Tie-in.....	4-13
4.5	DICKINSON BAY GATE	4-24
4.6	CLEAR LAKE CHANNEL AND GATE	4-25
5.0	BEACH AND DUNE SYSTEM DESIGN – BOLIVAR & WEST GALVESTON	5-1
5.1	SCOPE OF WORK.....	5-1
5.1.1	Representative Existing Conditions Profiles	5-2
5.1.2	Initial Design Profile	5-4
5.1.3	Construction Template	5-6
5.2	TENTATIVE DESIGN.....	5-8
5.2.1	Berm	5-9
5.2.2	Dune Foundation	5-9
5.2.3	Dune Optimization	5-10
5.3	CSRM TENTATIVELY SELECTED PLAN (TSP)	5-12
5.4	SEDIMENT SOURCE INVESTIGATION.....	5-16
5.5	BEACH DRAINAGE.....	5-17
5.5.1	West Galveston.....	5-17
5.5.2	Bolivar Peninsula	5-17
6.0	STRUCTURAL DESIGN.....	6-1
6.1	SCOPE.....	6-1
6.2	ANALYSIS/DESIGN.....	6-2
6.3	BOLIVAR ROAD SURGE BARRIER SYSTEM	6-3
6.3.1	Gate Selection.....	6-3
6.3.2	Bolivar Road Crossing Features	6-7
6.3.3	Combi-Wall.....	6-8
6.3.4	Vertical Lift Gates	6-10
6.3.5	Shallow Water Environmental Gates (SWEG).....	6-12
6.3.6	Navigation Gates	6-15
6.3.7	125’ Recreational Vessel Sector Gate	6-16
6.3.8	650’ Houston Ship Channel Gates.....	6-16
6.4	CSRM FEATURES IN GALVESTON ISLAND	6-18
6.4.1	Flood Wall.....	6-18
6.5	OFFATTS BAYOU CROSSING	6-19
6.6	ANALYSIS	6-20
6.6.1	Vessel Requirements:	6-20
6.6.2	Determination of Gate Width	6-21
6.6.3	Structural Analysis, Load Cases and Factors & Future Investigations	6-24
6.7	SCOUR PROTECTION	6-25
6.8	SEAWALL IMPROVEMENT	6-1
7.0	ECOSYSTEM RESTORATION RECOMMENDED PLAN	7-1

7.1	CHANGES TO ER MEASURES FOLLOWING THE AGENCY DECISION MILESTONE.....	7-1
7.2	G-28 – BOLIVAR PENINSULA AND WEST BAY GIWW SHORELINE AND ISLAND PROTECTION.....	7-1
7.3	B-2 – FOLLETS ISLAND GULF BEACH AND DUNE RESTORATION.....	7-3
7.4	B-12 – WEST BAY AND BRAZORIA GIWW SHORELINE PROTECTION.....	7-5
7.5	CA-5 – KELLER BAY RESTORATION.....	7-6
7.6	CA-6 – POWDERHORN SHORELINE PROTECTION AND WETLAND RESTORATION.....	7-7
7.7	M-8 – EAST MATAGORDA BAY SHORELINE PROTECTION.....	7-8
7.8	SP-1 – REDFISH BAY PROTECTION AND ENHANCEMENT.....	7-10
7.9	W-3 – PORT MANSFIELD CHANNEL, ISLAND ROOKERY, AND HYDROLOGIC RESTORATION.....	7-11
7.10	INVESTIGATIONS AND ANALYSIS REQUIRED DURING PRECONSTRUCTION ENGINEERING AND DESIGN (PED).....	7-13
8.0	SOUTH PADRE ISLAND (SPI).....	8-1
9.0	OPERATION, MAINTENANCE, REPAIR, REPLACEMENT AND REHABILITATION (OMRR&R).....	9-1
9.1	BOLIVAR AND WEST GALVESTON – OPERATION AND MAINTENANCE, REPAIR, REHABILITATION AND REPLACEMENT.....	9-1
9.2	UPPER TEXAS COAST SURGE BARRIER.....	9-4
9.3	GALVESTON RING BARRIER SYSTEM.....	9-6
9.4	ENVIRONMENTAL RESTORATION SYSTEM.....	9-6
9.5	BOLIVAR GATE OPERATION.....	9-6
9.6	RELOCATIONS.....	9-8
9.6.1	Pipelines and Utilities.....	9-8
9.6.2	Pipelines and Utilities for the Recommended Plan.....	9-9
9.6.3	Pipelines in Vicinity of Clear Lake and Dickinson Bay.....	9-14
9.6.4	Relocation Method.....	9-16
9.6.5	Storm Drain Modifications.....	9-16
10.0	COST ESTIMATE.....	10-1
10.1	CONTINGENCIES.....	10-2
10.1.1	Account Code 01 -- Lands and Damages.....	10-2
10.1.2	Account Code 02 – Relocation.....	10-2
10.1.3	Account Code 06 – Fish and Wildlife Facilities (Mitigation).....	10-3
10.1.4	Account Code 10 – Breakwater and Seawall.....	10-3
10.1.5	Account Code 11 – Levees and Floodwalls.....	10-4
10.1.6	Account Code 12 – Navigation Ports and Harbors.....	10-4
10.1.7	Account Code 13 – Pump Stations.....	10-5
10.1.8	Account Code 15 – Floodway Control-Diversion Structure.....	10-5
10.1.9	Account Code 17 – Beach Replacement.....	10-6
10.1.10	Account Code 18 -- Cultural Resources Preservation.....	10-6
10.1.11	Account Code 19 – Buildings, Grounds & Utilities.....	10-6
10.1.12	Account Code 30 -- Engineering and Design.....	10-6

10.1.13	Account Code 31 -- Construction Management	10-6
10.2	NER FEATURES	10-7
10.2.1	Account Code 01 -- Lands and Damages	10-7
10.2.2	Account Code 06 -- Fish and Wildlife Facilities	10-7
10.2.3	Account Code 10 -- Breakwaters and Seawalls	10-7
10.2.4	Account Code 11 -- Levees and Floodwalls	10-7
10.2.5	Account Code 12 -- Navigation Ports and Harbors	10-8
10.2.6	Account Code 17 -- Beach Replacement	10-8
10.2.7	Account Code 18 -- Cultural Resources Preservation	10-8
10.2.8	Account Code 30 -- Engineering and Design	10-9
10.2.9	Account Code 31 -- Construction Management	10-9
11.0	RISK AND UNCERTAINTIES	11-1
11.1	LIMITATION IN H&H MODELING	11-1
11.1.1	Rainfall	11-1
11.1.2	Surge Modeling Limitation	11-1
11.1.3	Optimization of Beach and Dune System	11-1
11.1.4	Sediment Budget	11-2
11.1.5	Optimization of Galveston Ring Barrier System	11-2
11.1.6	Compound Flooding and Sizing of Pumps	11-2
11.1.7	Relative Sea Level Change	11-4
11.2	LIMITATIONS IN GEOTECHNICAL INVESTIGATION	11-4
11.2.1	Surge Barrier System and Ring Levee System	11-4
11.2.2	Beach and Dune System	11-5
11.2.3	Deep Pile Driving	11-5
11.3	LIMITATIONS IN STRUCTURAL DESIGN	11-6
11.4	LIMITATIONS IN ANCHORAGE AREA MITIGATION DESIGN	11-8
11.5	SAN LUIS PASS	11-8
11.6	FUTURE OPTIMIZATIONS, ADAPTATIONS & RESILIENCY	11-10
11.6.1	Long Term Exceedance Probability (LTEP)	11-11
12.0	CONSTRUCTION SCHEDULE	12-1
12.1	BOLIVAR ROAD SURGE BARRIER SYSTEM	12-1
12.1.1	Concurrent Contracts	12-2
12.2	ER, BEACH AND DUNE SYSTEM	12-3
12.3	GALVESTON RING BARRIER AND SEAWALL IMPROVEMENT	12-4
12.3.1	Concurrent Contracts (GRBS)	12-5
LITERATURE CITED		I

LIST OF TABLES AND FIGURES

FIGURES

Figure 1-1: Coastal Texas Study Area	1-2
Figure 1-2: General Layout of the Tentatively Selected Plan (Region 1).....	1-4
Figure 1-3: Texas City Hurricane Flood Protection.....	1-7
Figure 1-4: Lynchburg Pump Station	1-8
Figure 1-5: Galveston Seawall.....	1-9
Figure 2-1: Study Area in the Vicinity of Galveston Bay Where Color Contour Represents Depth in Meters	2-1
Figure 2-2: NOAA Tide Gauges along the Texas Coast	2-5
Figure 2-3: Comparison between Predicted Water Surface Elevations and Verified Elevations for the Eagle Point Gauge During 2010.....	2-6
Figure 2-4: Major Texas River Basins.....	2-7
Figure 2-5: Major Bay Systems along the Texas Coast.....	2-8
Figure 2-6: Locations of Reported Salinity Data	2-9
Figure 2-7: Long-term Shoreline Change along the Texas Coast (Paine et al., 2014).....	2-11
Figure 2-8: Tide Gauge Location Map	2-14
Figure 2-9: Datum for Galveston Pier 21 (Epoch 1983–2001), Revised and Accepted April 17, 2003.....	2-15
Figure 2-10: Historic LMSL trend of 2.1 Feet per 100-year (0.021 foot/year) Combining Subsidence and Eustatic Trend	2-16
Figure 2-11: Relative Sea Level Rise at Pier 21 Using USACE and NOAA Rates.....	2-16
Figure 2-12: Relative Sea Level Change Projections from Year 1992 (Epoch 1983–2001) to Year 2100 (Galveston Pier 21).....	2-17
Figure 2-13: Distribution of Nonlinear Residuals in Superposition of Sea Level Rise	2-21
Figure 2-14: Extent of Inundation at Galveston, Texas with 2-foot Sea Level Rise Scenario from Present Condition	2-22
Figure 2-15: Track Time History for Tropical Synthetic Storm Number 342	2-23
Figure 2-16: Maximum Surge Elevation from Storm #342 (Without Project)	2-24
Figure 2-17: With-project Condition (The Recommended Plan).....	2-25
Figure 2-18: Maximum Surge Elevation from Storm Number 342 (With Project)	2-26
Figure 2-19 : Difference in SWL for Storm 342 Under Without-Project and With-Project Condition.....	2-26
Figure 2-20: Comparison of water surface elevation for storm 342 (right hand side) at six (6) save point locations for four (4) different configurations. The left hand side shows the corresponding wind direction (as normalized vectors), wind speed and atmospheric pressure	2-28
Figure 2-21: Location Map of Example Observation Stations	2-29
Figure 2-22: Hazard curves at 90% Confidence Interval (CI) at representative stations (Present RSLC scenario- SLC0 condition).....	2-31
Figure 2-23: Hazard curves for 4 scenarios for SP 15863 (Clear Lake Area)	2-32
Figure 2-24: Hazard curves for 4 scenarios for SP 15292 (Galveston Mid Bay)	2-32

Figure 2-25: 1% AEP SWL (Without Project, Year 2035, Intermediate RSLC).....	2-33
Figure 2-26: 1% AEP SWL (With-Project, Year 2035, Intermediate RSLC)	2-34
Figure 2-27: WP and WOP SWL Difference Map (1% AEP, Year 2035, Intermediate RSLC)	2-34
Figure 2-28: WP and WOP SWL Difference Map (0.5% AEP, Year 2035, Intermediate RSLC)	2-36
Figure 2-29: Impact of Gate Closure on Storm Track (Storm #270).....	2-36
Figure 2-30: GRBS system with arrows representing linear shoaling to transform waves to structure.....	2-38
Figure 2-31: Timeseries of water surface elevation and wave heights (top), overtopping rates (bottom).....	2-39
Figure 2-32: GRBS System Height Sensitivity on RSLC Scenario.....	2-41
Figure 2-33: Variations in With-Project SWL.....	2-43
Figure 2-34: Difference in Elevations Between Front and Back Side of Surge Barrier	2-44
Figure 2-35: Schematics of Seawall Extension	2-44
Figure 2-36: Schematic of GRBS Drainage and Pump Station Developed by Mott MacDonald.....	2-46
Figure 2-37: Clear Lake Crossing.....	2-48
Figure 2-38: Clear Lake Gate Closure System with Pump Station Footprint (Annex 5).....	2-49
Figure 2-39: Dickinson Bay Crossing	2-50
Figure 2-40: Dickinson Bay Gate Closure System with Pump Station Footprint (Annex 2, Annex 5)	2-51
Figure 2-41: Revised Storm Surge Barrier Modeled (2019PWP) for the AdH model domain.	2-53
Figure 2-42: Year 2035 (present) Freshwater Inflows.....	2-54
Figure 2-43: Year 2085 (future) Freshwater Inflows.....	2-55
Figure 2-44: Point analysis locations. Circled locations discussed in this section.....	2-56
Figure 2-45: Percent Change in Tidal Amplitude for 2019PWP from PWOP	2-58
Figure 2-46: Change in Bottom Salinity for 2019PWP from PWOP	2-60
Figure 2-47: Change in Surface Velocity for 2019PWP from PWOP.....	2-62
Figure 2-48: Comparison of Recruitment a) base condition and b) with-project conditions	2-64
Figure 2-49: Outcome of PTM sensitivity simulations for without-project or base conditions (blue) and with-project conditions (WP) (orange).....	2-65
Figure 3-1: Galveston Harbor Entrance Channel Crossing	3-2
Figure 3-2: Bolivar Peninsula Beach and Dune System.....	3-2
Figure 3-3: Galveston Island Beach and Dune System.....	3-3
Figure 3-4: South Padre Island Beach and Dune Nourishment.	3-3
Figure 3-5: Galveston Seawall Reach.....	3-4
Figure 3-6: City of Galveston Ring Barrier (Outside of Seawall Portion).....	3-4
Figure 3-7: Ecosystem Restoration (ER) features.	3-5
Figure 3-8: General Soil Map, Galveston County, Texas.....	3-8
Figure 3-9: General Soil Map, Brazoria County, Texas.	3-8
Figure 3-10: Boring Plan on Galveston Island (Sea Wall to San Luis Pass)	3-10
Figure 3-11: Galveston Harbor Entrance Channel Crossing.....	3-12
Figure 3-12: Eastern Tie-in and Bolivar Peninsula Reach.....	3-14
Figure 3-13: Typical Beach Dune System Section	3-21
Figure 3-14: Proposed Galveston Harbor Entrance Channel and Anchorage Area Improvements	3-22

Figure 3-15: Typical Proposed Breakwater Section	3-23
Figure 3-16: Typical Proposed Temporary Confinement Berm Section for Marsh Restoration	3-23
Figure 3-17: CSRSM - Commercial Borrow Sources.....	3-25
Figure 4-1: Bolivar Peninsula Beach and Dune System.....	4-1
Figure 4-2: West Galveston Beach and Dune System	4-2
Figure 4-3: Typical Sand Fencing Installation Detail.....	4-4
Figure 4-4: Typical Walkover Section.....	4-4
Figure 4-5: Typical Walkover Ramp.....	4-5
Figure 4-6: Alignment of an Access Ramp	4-6
Figure 4-7: Houston Ship Channel Navigation Gate and Tie-In Structures	4-7
Figure 4-8: Existing Anchorage Areas A, B, and C	4-9
Figure 4-9: Anchorage Area Proposed by the Anchorage Working Group.....	4-10
Figure 4-10: Existing and Proposed Study Anchorage Areas.....	4-11
Figure 4-11: Operation Center.....	4-12
Figure 4-12: Galveston Ring Barrier System.....	4-13
Figure 4-13: Offatts Bayou Crossing.....	4-15
Figure 4-14: Offshore Breakwater.....	4-18
Figure 4-15: Dickinson Bay Gate System	4-25
Figure 4-16: Clear Lake Gate Closure System	4-26
Figure 5-1: Map of Galveston CSRSM line and corresponding morphologically similar transects	5-3
Figure 5-2: Five morphologically similar 2016 reaches identified on Galveston, profiles are averaged in BMAP to create representative cross section.....	5-4
Figure 5-3: Design profile translation (CEM Figure V-4-14) graphically represented	5-5
Figure 5-4: Construction template superimposed over design profile; CEM Figure V-4-33.....	5-6
Figure 5-5: Galveston XS1 beach equilibrium profiles with theoretically derived d50 versus reported average.....	5-8
Figure 5-6: Galveston existing and design beach profile configurations.....	5-10
Figure 5-7: Natural Dual Dune Complex on the East End of Galveston Island (August 2019)	5-11
Figure 5-8: 3D Representation of existing profile and tentatively selected plan with general beach dimensions	5-13
Figure 5-9: Typical dimensions and elevations for CSRSM tentatively selected design profile represented on Bolivar XS1 representative profile; dune side slopes are 1:5	5-14
Figure 5-10: Galveston XS1 TSP; Construction template volume = 7.5 cyd/ft, top elev. at +5', slope at 1:90	5-14
Figure 5-11: Galveston XS2 TSP; Construction template volume = 11.9 cyd/ft, top elev. at +5', slope at 1:90	5-15
Figure 5-12: Bolivar XS1 TSP; Construction template volume = 16.1 cyd/ft, top elev. at +6', slope at 1:70.....	5-15
Figure 5-13: Bolivar XS2 TSP; Construction template volume = 12.4 cyd/ft, top elev. at +5', slope at 1:80.....	5-16
Figure 6-1: Overall Structural Feature Map.....	6-1
Figure 6-2: Recommended Closure Systems (Deep Draft Group)	6-6
Figure 6-3: Bolivar Road Crossing CSRSM features	6-8
Figure 6-4: Bolivar Road Crossing (Artist Rendition)	6-8

Figure 6-5: Combi-wall (Conceptual Rendition).....	6-9
Figure 6-6: Combi-wall (Technical Drawing).....	6-10
Figure 6-7: Vertical Lift Gates (VLGs) (Conceptual Rendition).....	6-12
Figure 6-8: Vertical Lift Gates (VLGs) (Technical Drawing).....	6-12
Figure 6-9: Shallow Water Environmental Gates (SWEG) (Conceptual Rendition).....	6-13
Figure 6-10: Shallow Water Environmental Gates (SWEG) (Technical Drawing).....	6-14
Figure 6-11: Houston Ship Channel Gate Complex (Conceptual Rendition).....	6-15
Figure 6-12: Houston Ship Channel Gate Complex (Annex 19).....	6-15
Figure 6-13: Shallow Water Environmental Gates (SWEG).....	6-17
Figure 6-14: Galveston Ring Barrier System.....	6-18
Figure 6-15: Typical Floodwall Section for the GRBS.....	6-19
Figure 6-16: Offatts Bayou Crossing.....	6-20
Figure 6-17: Table V-5-9 Clearance Factors.....	6-22
Figure 6-18: Scout Pad along Bolivar Road Gate Complex.....	6-26
Figure 6-19: Typical Seal Wall Improvement Section (Annex 19).....	6-1
Figure 7-1: G-28 – Bolivar and West Bay GIWW Shoreline and Island Protection East.....	7-2
Figure 7-2: G-28 – Bolivar and West Bay GIWW Shoreline and Island Protection West.....	7-3
Figure 7-3: B-2 – Follets Island Gulf Beach and Dune Restoration.....	7-5
Figure 7-4: B-12 – West Bay and Brazoria GIWW Shoreline Protection.....	7-6
Figure 7-5: CA-5 – Keller Bay Restoration.....	7-7
Figure 7-6: CA-6 – Powderhorn Shoreline Protection and Wetland Restoration.....	7-8
Figure 7-7: M-8 – East Matagorda Bay Shoreline Protection.....	7-9
Figure 7-8: SP-1 – Redfish Bay Protection and Enhancement.....	7-11
Figure 7-9: W-3 – Port Mansfield Channel, Island Rookery, and Hydrologic Restoration.....	7-12
Figure 8-1: SPI Beach Nourishment Plan.....	8-2
Figure 9-1: Number of rebuilds per 50-year life cycle, average and average+1 standard deviation. TB1 is, for example, XS1 Bolivar and T2G is for XS2 Galveston.	9-2
Figure 9-2: Clear Lake Pipeline.....	9-15
Figure 9-3: Dickinson Bay Pipelines.....	9-15
Figure 11-1: Peak daily water level at NOAA-8771013 vs. Daily Rainfall at USC00414333.....	11-3
Figure 11-2: West Bay Bathymetry (source).....	11-9
Figure 11-3: Modeling with San Luis Pass.....	11-10
Figure 11-4: Graphical depiction of LTEP and duration/number of years.....	11-12
Figure 12-1: Coastal Texas Project Phases.....	12-1
Figure 12-2: Gantt Chart (CTXS Design and Construction Schedule).....	12-2

TABLES

Table 2-1: Notable Historic Texas Gulf Coast Storms.....	2-4
Table 2-2: Tidal Range Taken as the Difference between MHHW and MLLW at Various Stations along the Texas Coast.....	2-6
Table 2-3: Freshwater Inflow Estimates for Coastal Watersheds.....	2-8
Table 2-4: Salinity Data at Select Locations along the Texas Coast.....	2-10

Table 2-5: Long-term and Recent Shoreline Change Rates through Various Geomorphological Regions along the Texas Coast	2-11
Table 2-6: NOAA Tide Gauges in Coastal Texas with Greater than 40 Years of Data.....	2-14
Table 2-7: Relative Sea Level Change (NAVD, ft) at Regions 1-4 (Using Epoch 1992).....	2-19
Table 2-8: Relative Sea Level Change (NAVD, ft) at Regions 1-4 (Using Base Year 2017)	2-20
Table 2-9: 1% AEP Still Water Level (NAVD 88 meter) at representative points.....	2-30
Table 2-10: 1% AEP at 50% and 90% Confidence Interval (CI) SWL & Wave Condition	2-38
Table 2-11: Summary of Peak Overtopping Rates [cfs/ft] along extraction points (Figure 2-30).....	2-40
Table 2-12: 1% AEP with 90% CI SWL [ft NAVD88] for Dickinson Bay.	2-42
Table 2-13: 1% AEP with 90% CI SWL [ft NAVD88] for Clear Lake.....	2-42
Table 2-14: Elevation of Top of Wall and Sills.	2-42
Table 2-15: Overtopping flowrates and volumes for varying top elevations of seawall improvement. Testing conducted with and without 1 ft high by 3 ft wide return wall	2-45
Table 2-16: Design Pump Capacity along the GRBS System	2-47
Table 2-17: Point analysis location names.....	2-56
Table 2-18: Average tidal prism volume for analysis year.	2-57
Table 2-19: Tidal Amplitude and Percent Change from the Without-Project Alternatives.	2-59
Table 2-20: Bottom Salinity Change from the Without-Project Alternatives.....	2-61
Table 3-1: Soil Parameters for Slope Stability Analysis – Bolivar Peninsula Reach	3-15
Table 3-2: Soil Parameters for Slope Stability Analysis – Compacted Clay (Fat Clay or Lean Clay) Fill	3-15
Table 3-3: Soil Parameters for Settlement Analysis – Bolivar Peninsula Reach.....	3-15
Table 3-4: Soil Parameters for Foundation Analysis – Galveston Harbor Entrance Channel Crossing Reach.....	3-16
Table 3-5: Soil Parameters for Slope Stability Analysis – Galveston Ring Levee/ Floodwall Reach and West Galveston Island Reach	3-17
Table 3-6: Soil Parameters for Slope Stability Analysis – Compacted Clay (Fat Clay or Lean Clay) Fill	3-17
Table 3-7: Soil Parameters for Settlement Analysis – Galveston Ring Levee/ Floodwall Reach and West Galveston Island Reach.....	3-18
Table 3-8: Summary - Feasibility Level Geotechnical Design Analysis Results and Assumptions for CSRMs Features: Surge Barrier	3-19
Table 3-9: Summary - Feasibility Level Geotechnical Design Analysis Results and Assumptions for CSRMs Features: Beach and Dune System	3-20
Table 3-10: Summary - Feasibility Level Geotechnical Design Analysis Results and Assumptions for CSRMs Features: Galveston Ring Barrier System (GRBS).....	3-20
Table 5-1: Comparison of reported average grain size to theoretical equivalent grain size per region of study site	5-7
Table 5-2: SBEACH Output for Hurricane Ike - Inundation, Water Depth and Wave Height at the CSRMs line.....	5-12
Table 5-3: CSRMs Construction Volume Estimate	5-13
Table 6-1: Bolivar Roads Project Features	6-2
Table 6-2: Raw scores averaged across all participants.....	6-4
Table 6-3: Raw scores averaged across I-STORM member participants.	6-5
Table 6-4: Gate Selection Overview.....	6-7

Table 6-5: List of Design Vessels Considered.....	6-21
Table 6-6: Design Factors.....	6-21
Table 6-7: Channel Widths based on Table V-5-9 from EM 1110-2-1100	6-22
Table 6-8: Design Factors.....	6-23
Table 6-9: Channel Widths based on Table V-5-10 from EM 1110-2-1100	6-23
Table 6-10: Design Load Cases	6-25
Table 7-1: G-28 Sediment Volumes	7-3
Table 7-2: M-8 Sediment Volumes	7-10
Table 9-1: Bolivar and West Galveston Beach and Dune OMRR&R Features.....	9-1
Table 9-2: Number of Profile Rebuilds for Various Profiles, Alternatives, and Scenarios	9-3
Table 9-3: Re-nourishment Volume (MCY) and Rebuild Frequency with RSLC.....	9-3
Table 9-4: Pipelines and Utilities – Bolivar Dune System and Gate Crossing	9-10
Table 9-5: Pipelines and Utilities – Galveston Ring Barrier System Waterlines.....	9-11
Table 9-6: Pipelines and Utilities – Galveston Ring Barrier System Sewers	9-12
Table 9-7: Pipelines and Utilities – Galveston Ring Barrier System OH Electrical	9-13
Table 9-8: Pipelines and Utilities – Galveston Ring Barrier System Water Mains	9-14
Table 9-9: Pipelines and Utilities – Galveston Dune System	9-14
Table 9-10: Clear Lake Pipelines.....	9-15
Table 9-11: Dickinson Bay Pipelines	9-15
Table 9-12: Storm Drain Modifications.....	9-17

LIST OF ACRONYMS

ADCIRC.....	Advanced Circulation Model
AdH.....	ADaptive Hydraulics
ADM.....	Agency Decision Milestone
AEP.....	Annual Exceedance Probability
ATR.....	Agency Technical Review
BEG.....	Bureau of Economic Geology
BMAP.....	Beach Morphology Analysis Package
BUDR.....	Beneficial Use of Dredged Material
CI.....	Confidence Interval
CL.....	Confidence Level
CBRA.....	Coastal Barrier Resource Act
CO-OPS.....	Center for Operational Oceanographic Products and Services
CSHORE.....	Cross-Shore Numerical Model
CSRM.....	Coastal Storm Risk Management
CStorm-MS.....	Coastal Storm Modeling System
DIFR-EIS.....	Draft Integrated Feasibility Report-Environmental Impact Statement
DOC.....	Depth of Closure
EPA.....	Environmental Protection Agency
EPA SWWM.....	EPA Storm Water Management Model
ER.....	Ecosystem Restoration
ER (in reference to document title prefix).....	Engineering Regulation
ERDC-CHL.....	Engineering Research and Development Center–Coastal Hydraulics Laboratory
ETL.....	Engineering Technical Letter
FEMA.....	Federal Emergency Management Agency
FR.....	Feasibility Report
FWOP.....	Future Without-Project
GBF.....	Galveston Bay Foundation
GCCPRD.....	Gulf Coast Community Protection and Recovery District
GIWW.....	Gulf Intracoastal Waterway
GLO.....	Texas General Land Office
GRBS.....	Galveston Ring Barrier System
HCPCD.....	Harris County Flood Control District
HEC-HMS.....	Hydrologic Engineering Center Hydrologic Modeling System
HEC-RAS.....	Hydrologic Engineering Center River Analysis System
HFPP.....	Hurricane Flood Protection Project
HSC.....	Houston Ship Channel
HSDRRS.....	Hurricane and Storm Damage Risk Reduction System

ITR.....	Independent Technical Review
JPM-OS.....	Joint Probability Method of Optimum Sampling
LiDAR.....	Light Detection and Ranging
LMSL.....	Local Mean Sea Level
MHHW.....	Mean Higher-High Water Level
MLLW.....	Mean Lower-Low Water Level
MSL.....	Mean Sea Level
MWD.....	Mean Wave Direction
NAD.....	North American Datum
NAVD 88.....	North American Vertical Datum of 1988
NLR.....	Nonlinear Residuals
NOAA.....	National Oceanic and Atmospheric Administration
NWLON.....	National Water Level Observation Network
NWR.....	National Wildlife Refuge
OMRR&R.....	Operation, Maintenance, Repair, Rehabilitation, and Replacement
PED.....	Project Engineering and Design
PTM.....	Particle Tracking Model
PWOP.....	Present Without-Project
PWP.....	Present With-Project
RSLC.....	Relative Sea-Level Change
SBeaCh.....	Storm-induced BEACh CHANGE
SLR.....	Sea Level Rise
SMART.....	Specific, Measurable, Attainable, Risk-Informed, and Timely
STWave.....	Steady-State Wave Model
SWL.....	Still Water Level
TCOON.....	Texas Coastal Oceanic Observation Network
TNRIS.....	Texas Natural Resources Information System
TPCS.....	Total Project Cost Summary
TPWD.....	Texas Parks and Wildlife Department
TSP.....	Tentatively Selected Plan
TWDB.....	Texas Water Development Board
TWL.....	Total Water Level
TxDOT.....	Texas Department of Transportation
USACE.....	United States Army Corps of Engineers
USDA.....	United States Department of Agriculture
USGS.....	United States Geological Survey
WAM.....	Wave Model
WIS.....	Wave Information Studies

1.0 **GENERAL**

1.1 **PURPOSE AND CONTEXT**

This Engineering Appendix documents the preliminary engineering and conceptual designs for the Coastal Storm Risk Management (CSRМ) and Ecosystem Restoration (ER) features of the Coastal Texas Protection and Restoration Feasibility Study (Coastal Texas Study). It supports the viability of the Recommended Plan (RP), which is presented in the Coastal Texas Study Draft Integrated Feasibility Report–Environmental Impact Statement (DIFR-EIS).

The Coastal Texas Study is comprised of four regions along the Texas coast as shown in Figure 1-1. Current and future coastal storm conditions, together with long-term climate conditions, were used to delineate the water levels which were used to determine initial system alignment and structural configurations, which were greatly influenced by current infrastructure. The initial conceptual designs for the Tentatively Selected Plan (TSP) were presented for public comment, Agency Technical Review (ATR) and Independent Technical Review (ITR) in October 2018. Comments from these reviews provided great insights into functionality and acceptability of the system, leading to refinements and optimizations of the proposed features. These refinements focused on changes to the Galveston Bay Storm Surge Barrier System; including realignment of the Bolivar and West Galveston Beach and Dune System. Additional public outreach in 2019 led to additional refinements of the Galveston Bay Storm Surge Barrier System leading to the current Recommended Plan.

1.1.1 **Scope of Effort**

The engineering work performed in this study is feasibility level, consistent with the Specific, Measurable, Attainable, Risk-Informed, and Timely (SMART) planning process necessary to substantiate the RP. Available existing information was used to develop project features which were combined to form alternative plans. Sources of information include the Gulf Coast Community Protection and Recovery District (GCCPRD) Phase 1 through Phase 4 Reports, Federal Emergency Management Agency (FEMA), the U.S. Geological Survey (USGS), National Oceanic and Atmospheric Administration (NOAA), comparative studies, operations and maintenance (O&M) records, and damage risk assessment reports on existing systems. Limited geotechnical borings are used to validate existing data and to provide better site-specific data and information.

The preliminary engineering and conceptual design conducted during this study are of sufficient detail to substantiate the RP and baseline cost estimate. This includes the project alignment, type of structure and top of system elevation; but do not provide final design criteria or detail project features. Further investigation, engineering, and design analysis will be needed in future phases.

1.2 PROJECT OVERVIEW

This project includes the Texas Gulf Coast, from Sabine Lake to Brownsville, Texas, and is comprised of four geographic regions indicated on Figure 1-1. A portion of this study area was previously studied under the Sabine Pass to Galveston Bay Feasibility Study (and is currently in construction) and is not included in the Coastal Texas Study.

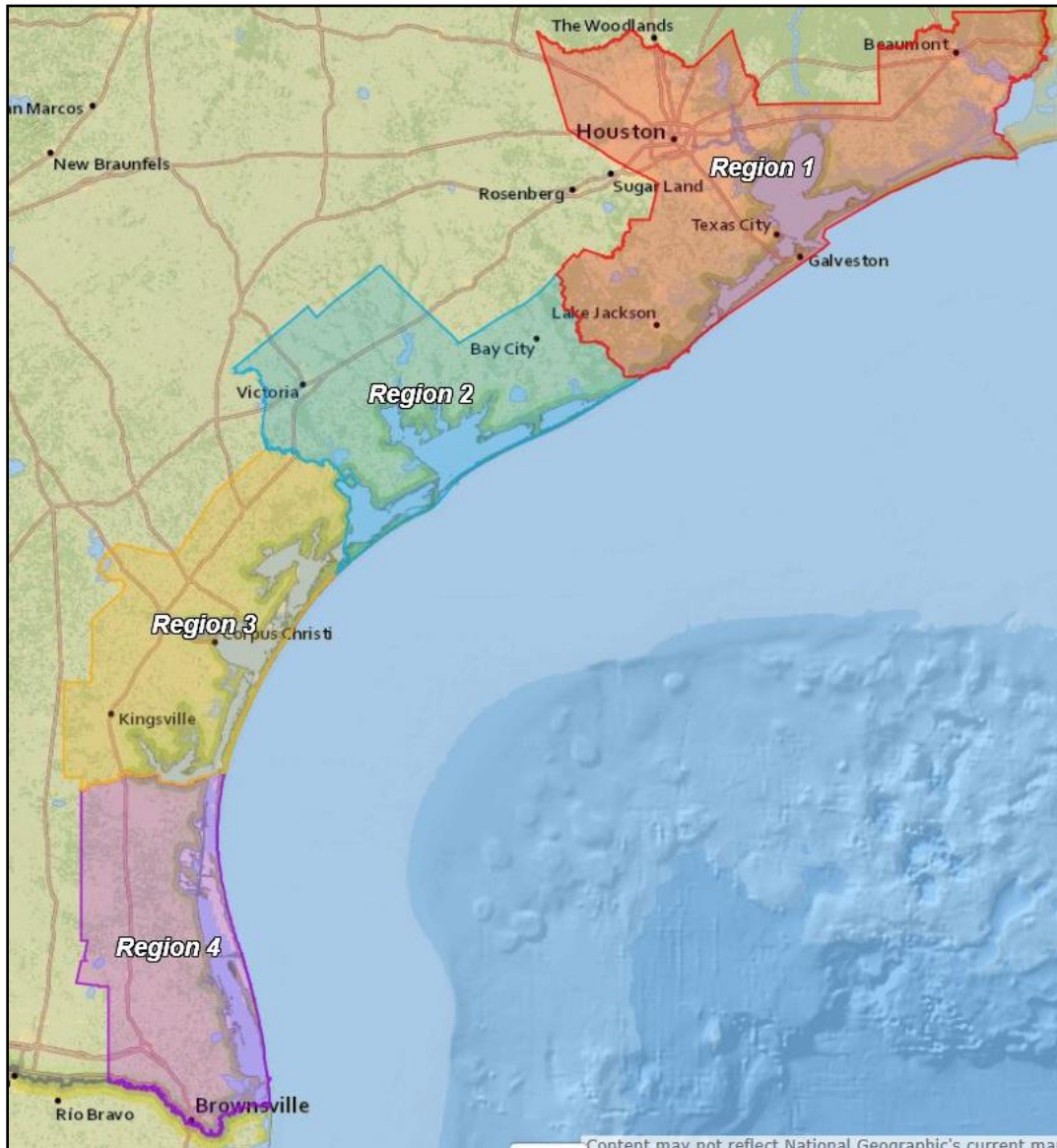

Figure 1-1: Coastal Texas Study Area

The Texas Coast is vulnerable to damage from storm surge, erosion, and inundation. Alternatives were formulated to address both Coastal Storm Risk Management (CSRM) and Ecosystem Restoration (ER). The DIFR-EIS presents the Recommended Plan which includes:

- 1) Storm surge protection in Region 1
- 2) Erosion protection in Region 4
- 3) Ecosystem restoration for Regions 1, 2, 3 and 4.

The Recommended Plan includes a combination of CSRM features along the seaward portion of the study area along Bolivar Peninsula and Galveston Island, with a storm surge barrier across Bolivar Roads, ring barrier and pump stations around Galveston city, smaller gates and pump stations across Offatts, Clear Lake and Dickinson Bay, along with beach fill in Region 4 and ecosystem restoration along the coast. The primary components include:

- A 2.-mile long Storm Surge barrier at Bolivar Roads across the entrance to the Houston Ship Channel, between Bolivar Peninsula and Galveston Island
- 43 miles of Beach and Dune system along Bolivar Peninsula and West Galveston Island that work with the storm surge barrier to reduce storm surge impacts
- A 16-mile ring barrier system around Galveston city consisting levee and flood walls, A modification of the existing 8-mile seawall section to provide an additional 2-3 feet of storm surge overtopping defense.

The most critical component of the CSRM plan, and the features with the most significant possible impacts are proposed in Region 1. Therefore, the engineering analysis presented in this appendix is focused on the evaluation of CSRM features in Region 1.

Figure 1-2 shows the general layout of the Region 1 CSRM and ER features that have been carried forth as RP and are discussed in detail in the current Appendix. The feasibility level design and analyses are performed to meet the engineering requirements detailed in ER 1110-2-1150, Engineering and Design for Civil Works Projects.

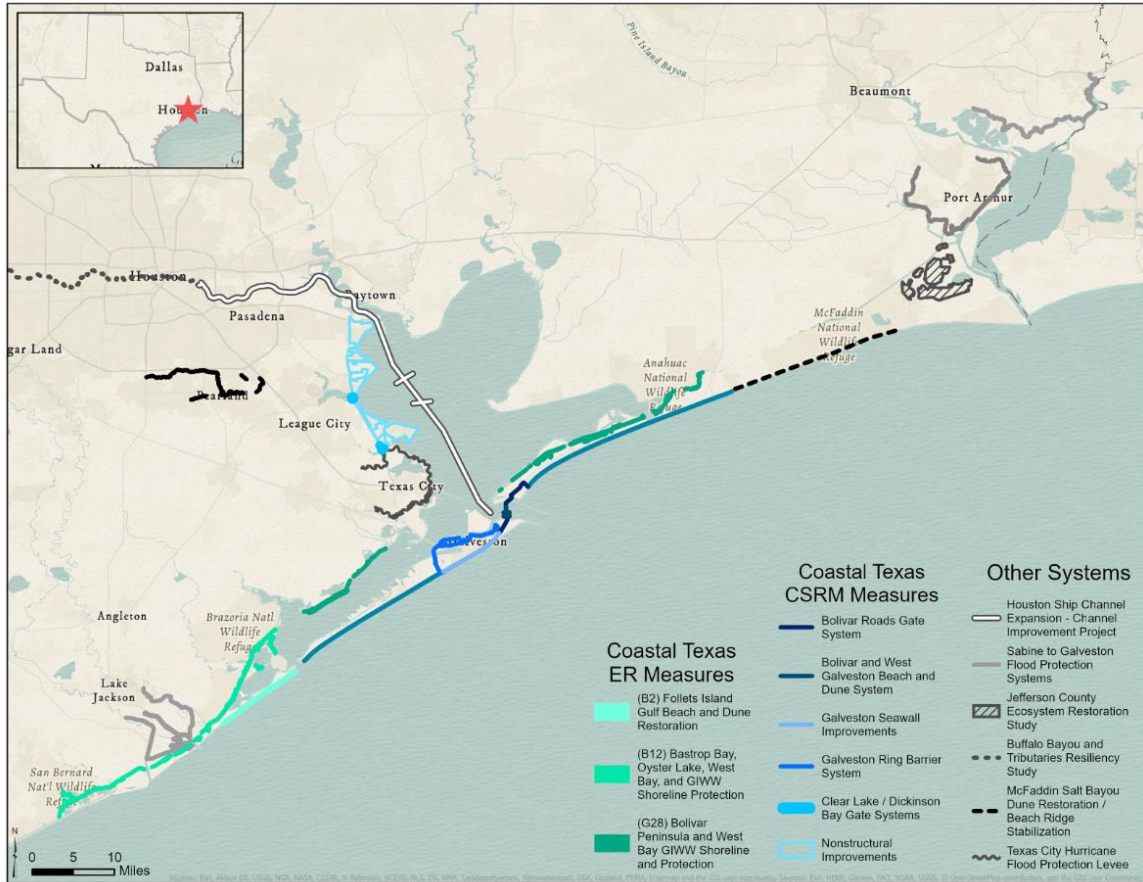

Figure 1-2: General Layout of the Tentatively Selected Plan (Region 1)

1.3 ORGANIZATION OF THE REPORT

Technical narratives of the CSR and ER features presented in this Appendix are broken into technical disciplines such as: Hydraulics and Hydrology, Geotechnical, Civil & Structural, and Cost, in accordance with the guidance in Engineering Regulation (ER) 1110-2-1150. The preliminary engineering and conceptual design conducted during this study support the project alignment and configuration of structure using different models with assumptions; but do not finalize design criteria or detail project feature design. The Sections are organized as follows:

- Hydrology and Hydraulics — Section 2.0
- Geotechnical Design and Assumptions — Section 3.0
- Civil and Structural Design — Section 4 to 6
- Ecosystem Restoration — Section 7.0
- South Padre Island – Section 8.0
- Cost Development for the CSR and Ecosystem Restoration Measures — Section 10.0
- Risk and Uncertainties – Section 11.0
- Tentative Construction Schedule – Section 12.0

1.4 **PROJECT COORDINATION**

The Texas General Land Office (GLO) is the Local Sponsor and an active part of the study team. The Gulf Coast Community Protection and Recovery District (GCCPRD) has done extensive studies for like purpose in the same area; therefore, extensive collaboration and coordination exists with this group. There are existing Hurricane Flood Protection Projects (HFPP) in Texas City, Galveston Sea Wall, and the Lynchburg Pump Station which are included in this study; coordination with the levee safety team was critical in developing proposed features. Coordination with Engineering Research and Development Center–Coastal Hydraulics Laboratory (ERDC-CHL), FEMA, U.S. Environmental Protection Agency (EPA) and other state and governmental agencies were vital for this study. The interdisciplinary Project Delivery Team (PDT) collaborated with subject matter experts and engaged with the Vertical Team (VT) throughout the plan formulation process. Agency Technical Reviews (ATRs) and In-Progress Reviews were conducted at key development stages.

1.5 **PROJECT DATUM**

The horizontal and vertical datum used in the engineering analyses and models conform to the current Federal standard. Horizontal coordinates are referenced to North American Datum (NAD) of 1983. Elevations of features related to Coastal Storm Risk Management (CSRМ) and Ecosystem Restoration (ER) are referenced to the North American Vertical Datum of 1988 (NAVD 88), unless otherwise stated. For QA/QC, engineering PDT team coordinated with the District’s datum coordinator Mr. Matthew Duke to review relevant documents referenced in this Appendix to make sure that the team are in compliance with the ER 1110-2-8160 guidance. More information on project datum is available in Section 2.4.

1.6 **DESIGN CONSIDERATIONS**

The feasibility level design and analyses are performed to meet the engineering requirements detailed in ER 1110-2-1150, Engineering and Design for Civil Works Projects. For geotechnical evaluation, primarily Engineer Regulation 1110-2-1806 has been followed to guide design processes. Additional details are available in Section 3.0. Sufficient Civil and Structural designs were performed to meet the engineering requirements specified for a feasibility study detailed in ER 1110-2-1150, Engineering and Design for Civil Works Projects. Additional details are available in Section 5.0 and 6.0. For hydrology and hydraulics, ER 1110-2-1150, EM 1100-2-1000, ER 1100-2-8162, Engineering Technical Letter (ETL) 111 2 1, and other regulations are followed. Details can be found in Section 2.0. The Hurricane and Storm Damage Risk Reduction System (HSDRRS) design guidelines (USACE 2012) criteria were applied to estimate crest elevation. The criteria used for conceptual design of the systems and crest elevations is fundamentally based on damage overtopping limit state with annual exceedance probability of 1%. This is consistent with present USACE practice and other recent regional projects such as Sabine to Galveston Study (S2G PED). USACE ETL 1100-2-1, 2014 recommends an expansive

approach to considering and incorporating Relative Sea Level Change (RSLC) into civil works projects which has been followed here. Flood-damage reduction potential for alternatives is based on damages that would be prevented under average still-water levels (SWL), while also considering RSLC, wave set-up, and run-up. Given that some of the project features can remain in service much longer than the period of analyses (typically 50-year), planning horizon, especially on adaptation strategy are explored up to 100 years, consistent with ER 1110-2-8159, ER 1100-2-8162. This is explored in Section 11.0. The preliminary engineering and conceptual design conducted during this study support the project alignment, type of structure and top of system elevation; but do not finalize design criteria or detail project features. Further investigation, engineering, and design analysis will be needed in future phases. As an example, ERDC performed storm surge modeling using Low and High RSLC conditions before calculating probabilistic SWL. Later, SWL, RSLC, and wave overtopping values were considered in determining the top of system elevation and system alignment. This feasibility design is of sufficient detail to substantiate the RP and baseline cost estimate.

Plan features included in the Galveston Bay Storm Surge Barrier System include:

- Bolivar Roads Gate System
 - Deep-draft-navigation 650' sector gates
 - 125' sector gates
 - Vertical lift gates
 - Shallow water environmental gates (SWEG)
 - Galveston Island control/ visitor center
 - Bolivar auxiliary control center
 - Bypass channel
 - Combi-wall and levee tie in
 - Anchorage areas
- Bolivar and West Galveston Beach and Dune System
 - Dune field
 - Dune walkovers & drive overs
 - Beach & berm
 - Drainage
- Galveston Ring Barrier System
 - Galveston Seawall Improvements
 - West Harborside Breakwater
 - Offatts Bayou Closure
 - Pump stations
- Clear Lake Gate System
- Dickinson Bay Gate System

Primary features considered for the Ecosystem Restoration features are:

- Marsh restoration
- Island restoration/creation
- Dredging
- Breakwater
- Oyster Cultch

1.7 DESCRIPTION OF EXISTING CSRM FEATURES RELEVANT TO THE PROJECT

1.7.1 Texas City Hurricane Flood Protection Project (TCHFPP)

The TCHFPP is Federally authorized and locally operated and maintained. The system was authorized and designed to provide risk reduction to 36 square miles for tides up to and including a hurricane tide 15 feet above the National Geodetic Vertical Datum (NGVD). The system consists of 15.9 miles of earthen embankment having a maximum height of 23 feet, 1.3 miles of concrete floodwall, a tidal control and navigation structure, and two interior pumping stations (Figure 1-3).



Figure 1-3: Texas City Hurricane Flood Protection

1.7.2 Lynchburg Pump Station

The Lynchburg Pump Station is federally authorized, but locally operated and maintained. The Lynchburg Pump Station Hurricane Flood Protection Levee is 0.76 mile long which provides risk reduction from hurricane storm surge to the pump station that provides drinking water for the city of Houston (Figure 1-4). The levee system consists of an earthen embankment with one drainage structure, one moveable gate, and “I”-wall segments. The project is located on the east side of the Houston Ship Channel (HSC) where the San Jacinto River merges with the ship channel, in the far north end of Galveston Bay. No permanent residents are located inside of the protected area; infrastructure is all that is protected by the system.



Figure 1-4: Lynchburg Pump Station

1.7.3 Galveston Seawall

The Galveston Seawall (Figure 1-5) is located on Galveston Island, extending from the South Jetty approximately 10 miles along the Gulf of Mexico. It was constructed in stages from 1902 through 1963 with the purpose of reducing damages from wind-driven tides and waves to Galveston Island. The Galveston Seawall consists of a curved, concrete gravity section 16 feet wide at the base with a maximum top elevation 17 feet above mean low water.

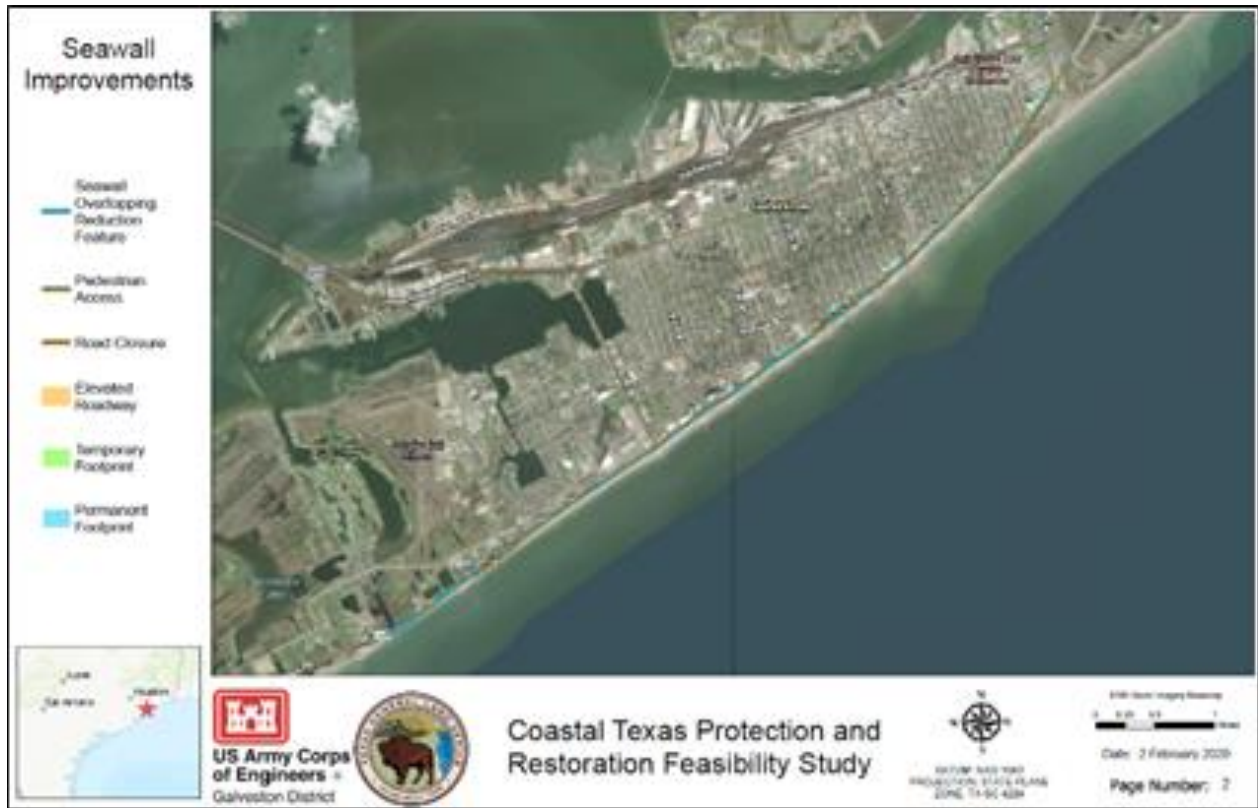

Figure 1-5: Galveston Seawall

1.8 DATA MANGEMENT PLAN

The Data Management Plan (DMP) provides process and procedures for management of data for the Coastal Texas Study. These procedures and policies are consistent with USACE regulations and Galveston District processes and includes management of both existing and new data.

While all personnel working on the Coastal Texas Study have a role in data quality control, the Galveston District Geospatial Program Manager and CADD Manager has primary responsibility for ensuring that accurate, efficient data management procedures are implemented and used. A GIS technical lead is assigned for gathering, managing, and updating data. The geospatial data is managed in accordance with Engineering and Construction Bulletin (ECB) No. SWG 2016-01 Geospatial Data Management Plan (GDMP) for Projects.

2.0

HYDROLOGY AND HYDRAULICS

2.1

INTRODUCTION

A SMART planning feasibility-level analysis of the storm surge, waves, and environmental conditions are conducted to provide preliminary design guidance for the Recommended Plan. Additionally, RSLC and impacts are assessed in accordance with ER 1100-2-8162 and Engineering Technical Letter ETL 111-2-1. Most of the H&H work conducted focused on the CSR alternatives in Region 1, surrounding Galveston Bay. Galveston Bay is located southeast of Houston, Texas, and consists of sub bays such as: Upper Galveston Bay, Trinity Bay, West Bay, and East Bay. Two major rivers, the Trinity and San Jacinto, discharge into the bay (Figure 2-1).

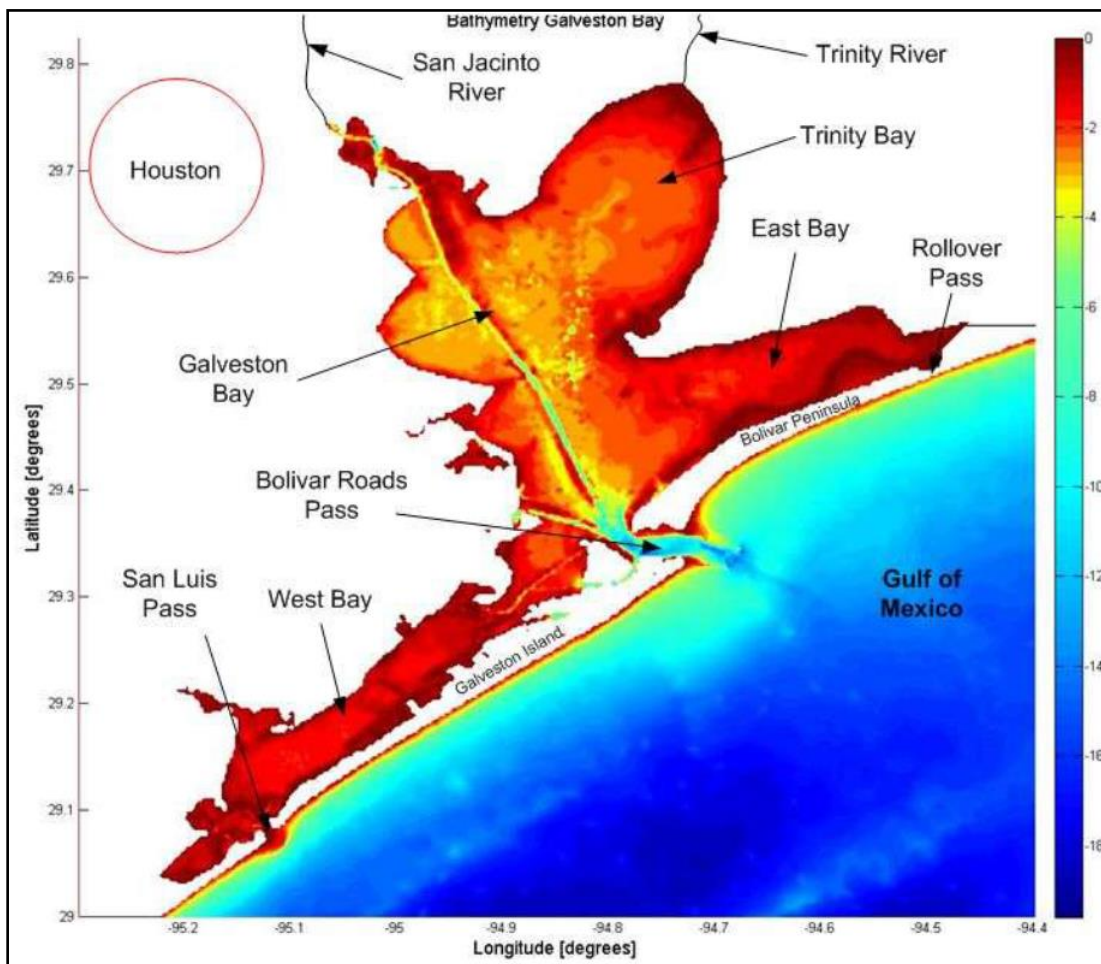

Figure 2-1: Study Area in the Vicinity of Galveston Bay Where Color Contour Represents Depth in Meters

- H&H analyses are key components in evaluating the Recommended Plan (RP). This section of the engineering appendix presents an overview of the H&H efforts performed to inform,

evaluate, and support the RP and an evaluation of its impacts. Hydraulic analyses were conducted to inform preliminary design of flood-protection system. Analyses were conducted to support design of the levees, gates, and floodwalls with the following general process: Gather existing data

- Analyze storm surge and waves
- Apply ADCIRC/STWAVE models to simulate large-scale storm surge and waves
- Output statistics for various return periods for waves and water levels along with quantification of uncertainty for surge and wave modeling results
- Local wave transformations and overtopping analysis to guide crest elevations
- Assess impacts using ADH and PTM models

2.2 **EXISTING DATA**

A wide variety of reports, models, design plans/as-built plans, feasibility studies, historical studies, watershed master plan studies, and many other studies were available. Additionally, the latest available tools including the Coastal Hazard System, the latest Environment Research and development Center (ERDC) storm modeling and environmental modeling capabilities, among others to the extent possible, were used in this study. It is recommended that some of the modeling be revisited when the project features are designed and optimized for construction, as the models are improved, and site conditions are changed.

2.2.1 **Topographic, Bathymetric, and Survey Data**

Light Detection and Ranging (LiDAR) data obtained from the Texas Natural Resources Information System (TNRIS) provided the detailed terrain information needed for the study. Bathymetry data was obtained from the NOAA Digital Coast and Global Relief World Data Services. Survey data in USACE possession, e.g., hydrographic surveys in the navigation channels, were also used. These data were used to develop the ADvanced CIRCulation Model (ADCIRC) and Adaptive Hydraulics (ADH) computational mesh for storm surge and hydraulic modeling. Since the mesh represented an amalgamation of available data, it was often used for elevation data.

2.2.2 **FEMA Data**

The FEMA Coastal Counties Report (2011) and associated electronic files were obtained and used in this study. The FEMA Coastal Counties Study covered the entire Texas coast and aided the initial evaluation of project features. FEMA data was available for the 10-year, 50-year, 100-year, and 500-

year SWL. The storm modeling was subsequently revisited and refined for this study. Additional discussion regarding storm surge modeling and analysis is discussed in Sections 2.5 and 2.6.

2.2.3 **Tropical Cyclones and Flood Records**

The Texas coast has long been susceptible to major storm events. Several significant hurricane events were recorded in the area as far back as the 1500s with devastating impacts to property and life. As demonstrated with the recent storm events of Hurricane Ike in 2008 and Hurricane Harvey in 2017, hurricanes continue to inflict large economic losses and human casualties in the region. From the 1500s to present day, hurricanes and tropical storms have made landfall in the state as early as June 2 and as late as November 5. August ranks as the most likely month that a major hurricane may strike the Texas coast. Since the 1850s, a total of 64 hurricanes and 56 tropical storms have been recorded in Texas (Roth, 2010). Most of these storms entered from the Gulf of Mexico, traveling northwest initially and then curving towards the north and northeast. Storms that hit early or late in hurricane season can sometimes move in from the southwestern portions of the Gulf due to cold fronts approaching from the north.

Texas has encountered many noteworthy hurricanes over the past century and a half. In 1886, a Saffir-Simpson scale Category 4 storm made landfall in Indianola. The high winds and 15-foot storm surge destroyed the once burgeoning port city. Just 14 years later, the Galveston Hurricane of 1900, one of the deadliest natural disasters of the United States, made landfall as a Category 4 storm. The storm claimed thousands of lives and left a lasting impact on the region's economy. Galveston, once the center of trade and one of the largest cities in Texas, never fully recovered as investors began to pool their money further inland near Houston. In addition to the high winds and storm surge from major hurricanes, the exorbitant amount of rainfall associated with tropical storms has also had a profound impact on Texas. Claudette, a Category 1 hurricane, made landfall in 1979 near Galveston and stalled over southeast Texas for 2 days. The city of Alvin set a national rainfall record receiving 42 inches of rain within a 24-hour time period. In addition, daily rainfall records were set at Corpus Christi, Victoria, and Laredo. Overall, the flooding associated with Claudette led to an estimated \$750 million (1979 United States Dollars [USD]) in damages. Most recently, Harvey, a Category 4 major hurricane, made landfall just east of Rockport, Texas, on August 26, 2017. Hurricane Harvey is listed as the wettest hurricane on record in the United States as many cities in eastern Texas received over 40 inches of rainfall. Harvey is tied with Katrina as the costliest U.S. tropical cyclone with an estimated \$125 billion (2017 USD) in damages. Table 2-1 summarizes major hurricanes and tropical storms that had affected the region.

Table 2-1: Notable Historic Texas Gulf Coast Storms

Date	Name	Location	Latitude	Longitude	Direction (degrees)	Speed (mph)	Wind Speed (mph)	Pressure (milli-bars)	Storm Type
9/16/1875	No name	Indianola	27.1	-94.9	275	14	100	--	Category 2
8/12/1880	No name	Brownsville	25.7	-96.9	300	10	150	931	Category 4
8/20/1886	No name	Indianola	28.0	-96.6	305	11	150	925	Category 4
9/8/1900	No name	Galveston	28.9	-94.7	305	13	140	936	Category 4
8/17/1915	No name	Galveston	28.9	-95.0	310	16	135	940	Category 4
9/14/1919	No name	Corpus Christi	26.5	-91.0	270	9	145	931	Category 4
8/13/1932	No name	Freeport	28.9	-94.7	320	11	145	942	Category 4
6/26/1954	Alice	S of Brownsville	24.9	-97.2	310	9	80	--	Category 1
9/5/1955	Gladys	S of Brownsville	23.4	-97.3	250	5	85	--	Category 1
6/27/1957	Audrey	Sabine Pass	29.3	-93.8	0	14	145	946	Category 4
7/25/1959	Debra	Galveston	28.8	-95.1	30	3	80	984	Category 1
9/11/1961	Carla	Port Lavaca	27.6	-96.2	310	5	165	935	Category 5
9/17/1963	Cindy	High Island	29.8	-94.4	0	3	75	997	Category 1
9/20/1967	Beulah	Brownsville	25.1	-96.8	330	11	160	931	Category 5
8/3/1970	Celia	Corpus Christi	27.5	-96.3	290	14	125	945	Category 3
9/10/1971	Fern	Matagorda	28.5	-95.3	320	6	75	988	Category 1
9/16/1971	Edith	E of Sabine Pass	29.5	-93.1	50	19	100	978	Category 2
8/9/1980	Allen	Port Mansfield	25.0	-94.2	295	12	180	909	Category 5
8/18/1983	Alicia	Galveston	28.9	-95.0	340	5	115	963	Category 3
6/26/1986	Bonnie	Beaumont	29.9	-94.3	330	11	75	992	Category 1
9/17/1988	Gilbert	S of Brownsville	23.9	-97.0	280	11	135	950	Category 4
8/1/1989	Chantal	High Island	29.5	-94.3	320	11	80	984	Category 1
10/16/1989	Jerry	Galveston Island	29.1	-95.0	340	11	85	983	Category 1
8/22/1999	Bret	Padre Island	25.5	-95.5	335	9	145	950	Category 4
7/15/2003	Claudette	Port O'Connor	28.3	-95.5	295	9	85	982	Category 1
9/24/2005	Rita	Sabine Pass	29.4	-93.6	325	10	115	935	Category 3
9/13/2007	Humberto	High Island	29.5	-94.4	25	8	90	985	Category 1
9/13/2008	Ike	Galveston Island	29.1	-94.6	325	10	110	951	Category 2
8/25/2017	Harvey	Rock Island	28.0	-96.9	310	5	132	937	Category 4

mph = miles per hour

As evident from Table 2-1, tropical cyclones along the Texas Gulf Coast occur frequently, averaging once every 6 years along any 50-mile stretch of coastline (Roth, 2010). It is important to note that these are storms that made landfall in Texas. They do not include storms that made landfall in Louisiana or Mexico but had significant impacts of surge and/or wind to the Texas coast, such as Hurricane Katrina in 2005.

2.3 PHYSICAL OCEANOGRAPHY

Here we discuss the hydrometeorological data and the physical oceanography of the Coastal Texas Study area including tides, currents, circulation, and salinity.

2.3.1 Tides

Tides are water-surface elevation changes induced by the gravitational forces associated with lunar cycles. Long-term water-level monitoring provides a characterization of tidal fluctuations. The NOAA Center for Operational Oceanographic Products and Services (CO-OPS) operates a network of water-level gauges along the Texas coast through their National Water Level Observation Network (NWLON) and supplemented by the Texas Coastal Oceanic Observation Network (TCOON) (Figure 2-2). Texas generally has diurnal tides and can be broadly characterized as a microtidal wave-dominated environment. The great diurnal tidal range, taken as the difference between mean higher-high water (MHHW) and mean lower-low water (MLLW) at various locations along the Texas Coast, is shown in Table 2-2. The tidal range at the deep-draft navigation inlets ranges from approximately 1.2 to 2.0 feet. The tidal range generally decays progressively into the bay systems.

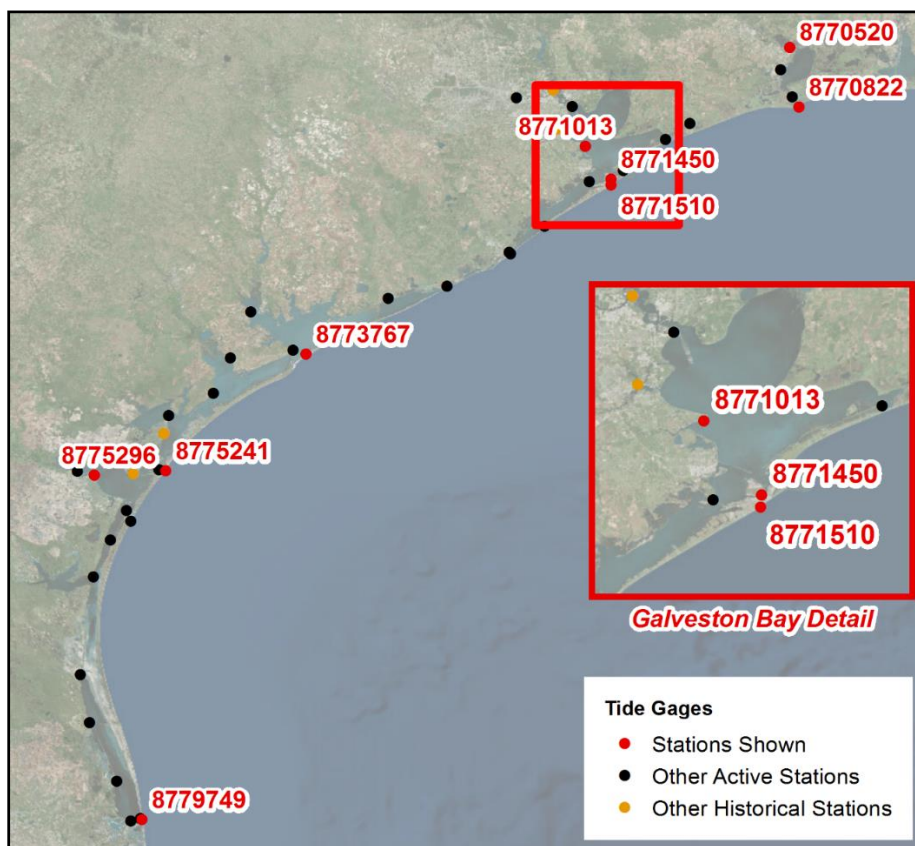

Figure 2-2: NOAA Tide Gauges along the Texas Coast

Table 2-2: Tidal Range Taken as the Difference between MHHW and MLLW at Various Stations along the Texas Coast

Gage Name	Gage Number	Range (feet)
Rainbow Bridge	8770520	1.06
Texas Point, Sabine Pass	8770822	1.96
Eagle Point	8771013	1.10
Galveston Pleasure Pier	8771510	2.04
Galveston Pier 21	8771450	1.41
Matagorda Bay Entrance Channel	8773767	1.23
Aransas Pass	8775241	1.36
USS Lexington	8775296	0.59
South Padre Island, Brazos Santiago	8779749	1.43

The astronomical tide is one of the environmental forces that dictate the water-surface elevation at a particular location; wind-driven current and fluvial discharge are also important controls of water-surface elevation. Texas has a weak astronomical tidal signal. This is evident by the poor predictive capability of the astronomical tides alone. For example, Figure 2-3 shows the predicted water-surface elevations based on the astronomical tides, alongside the verified water-surface elevation measurements for the Eagle Point gauge through 2010. Wind-driven currents have a large impact on water-surface elevations in the shallow Texas bays. Similarly, large fluvial discharges can be a much stronger control on water-surface elevation in upper bays relative to the effects of the astronomical tide.

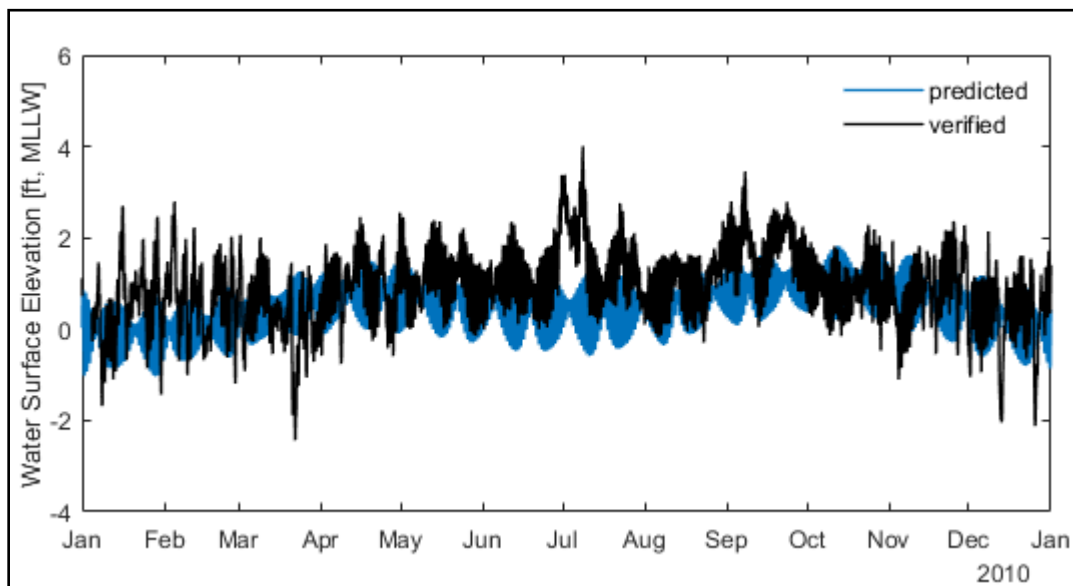

Figure 2-3: Comparison between Predicted Water Surface Elevations and Verified Elevations for the Eagle Point Gauge During 2010

2.3.2 Currents, Circulation, and Salinity

The major river basins and major bay systems in the study area are shown on Figure 2-4 and Figure 2-5, respectively. Circulation and salinity through the coastal Texas system is governed by a variety of factors: tides, winds, waves, and freshwater inflows. The freshwater inflow for the coastal watersheds has been collected and analyzed by the Texas Water Development Board (TWDB, 2017) as shown in Table 2-3.

Salinity in Texas bays is a function of saltwater inflow through tidal inlets and freshwater supply from upland tributaries. Other physical processes, e.g., evaporation and wind-driven currents, also impact the salinity regime and can be significant in certain areas along the coast. Data on physical water properties, e.g., salinity and temperature, along the Texas coast have been collected and made available by the Texas Parks and Wildlife Department (TPWD, 2017). Data are available for samples collected between 1976 and 2014. Several regions of interest were delineated (Figure 2-6) and summary statistics computed in those regions (Table 2-4) to be illustrative of the salinity regime along the coast. The reported values are the arithmetic mean values for all measurements available within the particular region of interest. This is a simplification given seasonal variability from differences in freshwater supply and evaporation. Salinities are broadly higher in late summer relative to the rest of the year.

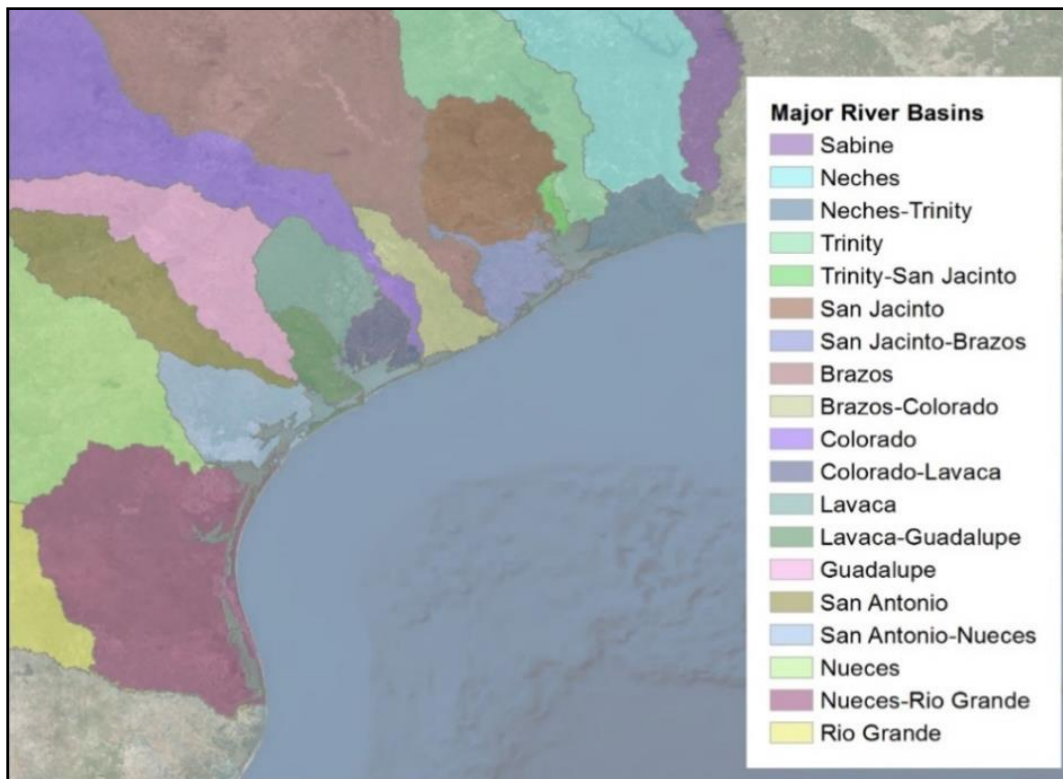

Figure 2-4: Major Texas River Basins

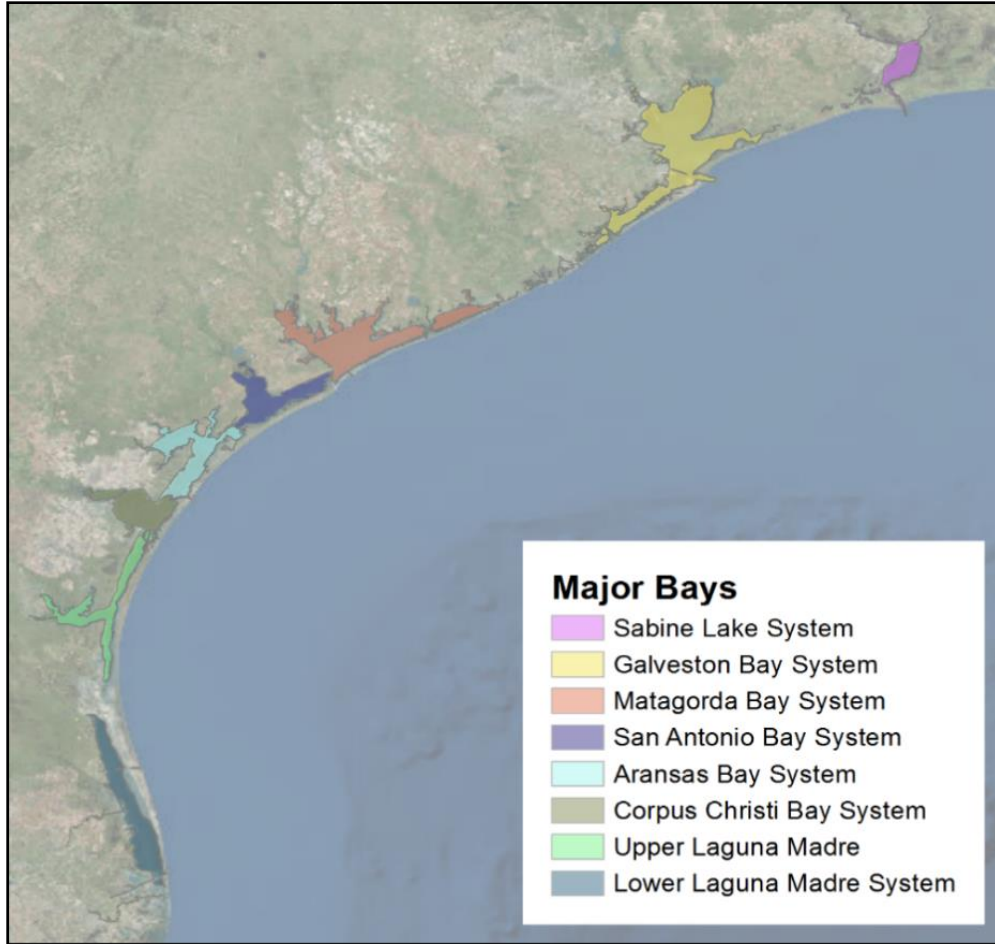

Figure 2-5: Major Bay Systems along the Texas Coast

Table 2-3: Freshwater Inflow Estimates for Coastal Watersheds

Watershed	Average Annual Freshwater Inflow (acre-feet)
Sabine Lake	13,117,800
Galveston Bay	9,627,400
Brazos River	5,389,800
San Bernard River	610,800
East Matagorda Bay	625,500
Matagorda Bay	3,539,600
San Antonio Bay	3,659,300
Aransas Bay	498,300
Corpus Christi Bay	580,200
Laguna Madre	771,400

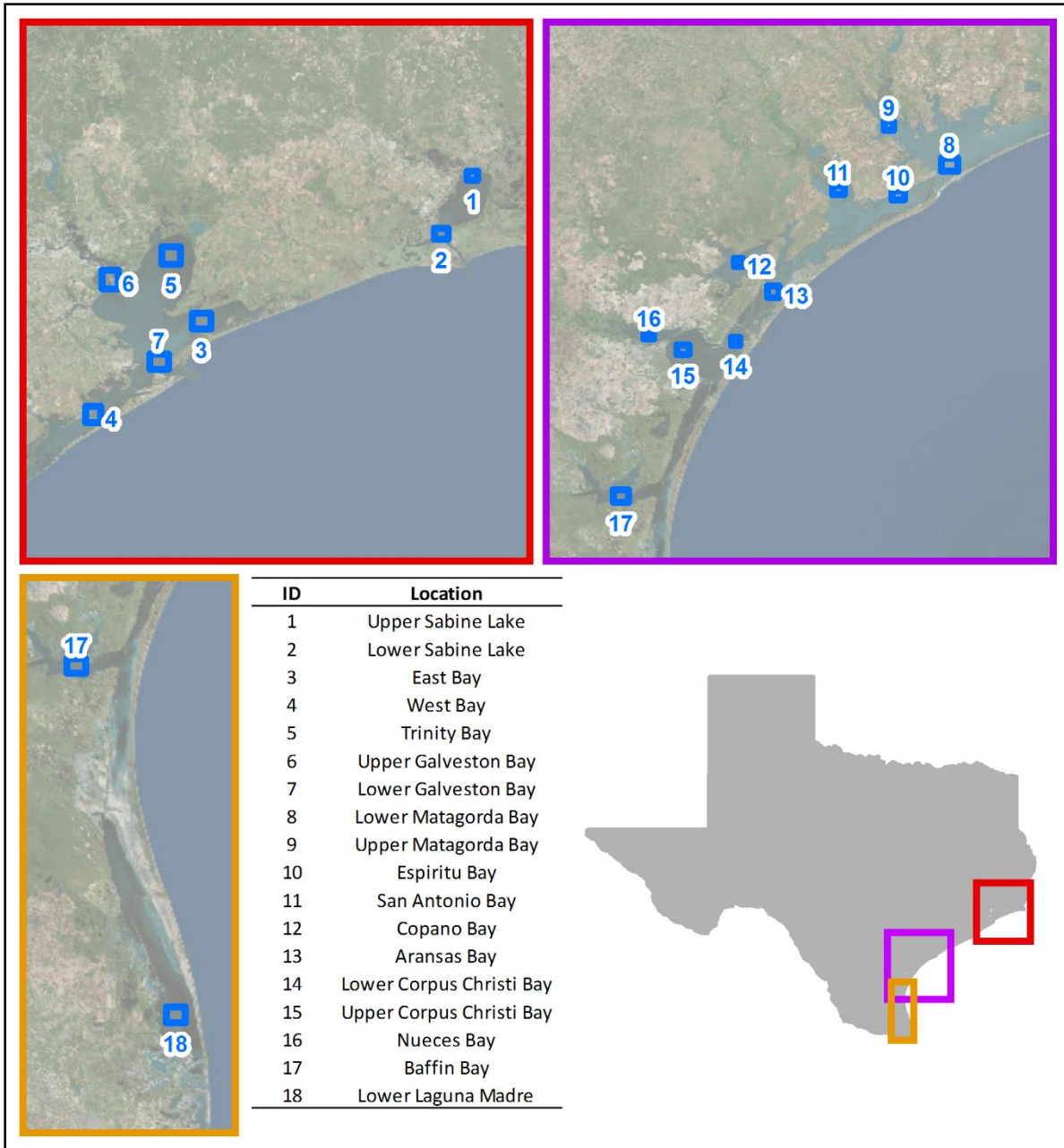

Figure 2-6: Locations of Reported Salinity Data

Table 2-4: Salinity Data at Select Locations along the Texas Coast

Location	Salinity (practical salinity units)		
	Average	Standard Deviation	Number of Samples
Upper Sabine Lake	6.7	5.9	264
Lower Sabine Lake	13.1	7.5	2,099
East Bay	15.0	6.3	974
West Bay	24.0	5.9	680
Trinity Bay	9.0	7.7	286
Upper Galveston Bay	13.5	6.5	491
Lower Galveston Bay	22.5	6.8	243
Lower Matagorda Bay	28.0	5.2	358
Upper Matagorda Bay	20.9	9.0	351
Espiritu Bay	25.2	7.7	398
San Antonio Bay	10.5	8.7	872
Copano Bay	18.2	9.7	582
Aransas Bay	23.8	7.7	601
Lower Corpus Christi Bay	30.5	4.5	417
Upper Corpus Christi Bay	31.6	4.6	357
Nueces Bay	26.1	10.5	270
Baffin Bay	39.8	12.3	524
Lower Laguna Madre	33.3	5.4	519

2.3.3 Historical Shoreline Changes

The Texas coast is generally erosive except for areas on the updrift side of navigation jetties. Shoreline change has been monitored by the Bureau of Economic Geology (BEG) at 50-meter intervals through remote sensing techniques and is reported by Paine et al. (2014). Figure 2-7 shows the long-term averaged shoreline change rates throughout Texas; the rates are summarized by geomorphic region in Table 2-5.

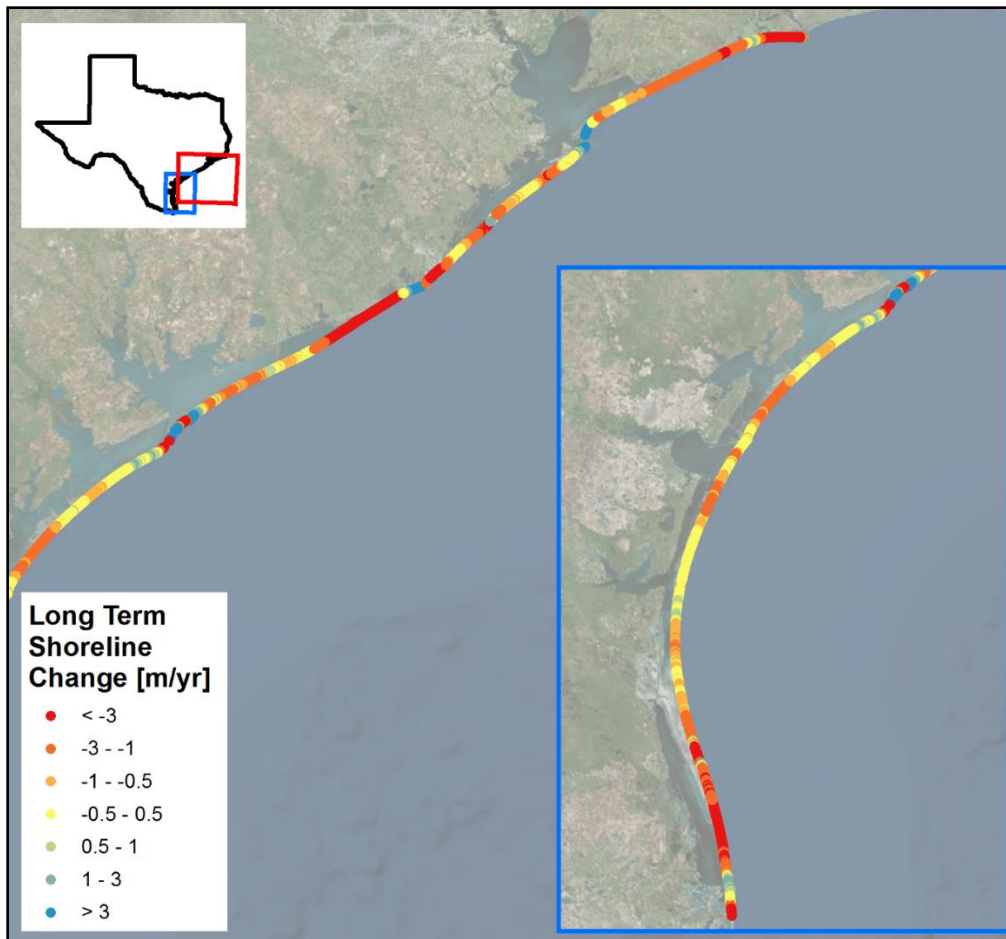

Figure 2-7: Long-term Shoreline Change along the Texas Coast (Paine et al., 2014)

Table 2-5: Long-term and Recent Shoreline Change Rates through Various Geomorphological Regions along the Texas Coast

Region	Long Term (1930s - 2012)			Recent (2000 - 2012)		
	Net Rate (m/yr)	Standard Deviation (m/yr)	Range (m/yr)	Net Rate (m/yr)	Standard Deviation (m/yr)	Range (m/yr)
Sabine Pass to Rollover Pass	-2.94	2.66	-11.7 to 9.3	-4.66	3.52	-15.9 to 2.8
Bolivar Peninsula	0.41	2.72	-1.8 to 14.6	-0.66	1.57	-10.5 to 4.5
Galveston Island	-0.27	1.85	-2.7 to 6.5	0.98	2.8	-5.1 to 24.9
Brazos/Colorado Headland	-2.08	5.48	-13.0 to 20.5	-1.34	5.12	-38.9 to 16.5
Matagorda Peninsula	-1.00	2.83	-10.3 to 20.1	-0.57	3.85	-11.7 to 19.4
Matagorda Island	-0.74	3.80	-16.8 to 16.1	-1.24	4.91	-15.9 to 4.8
San Jose Island	-0.74	0.47	-1.6 to 0.4	1.08	1.48	-4.0 to 12.7
Mustang Island	-0.34	0.61	-1.9 to 0.4	0.08	1.87	-4.0 to 30.4
North Padre Island	-0.82	0.98	-4.5 to 1.1	-1.14	1.19	-5.0 to 11.0
South Padre Island	-2.27	1.91	-7.5 to 3.4	-1.57	1.61	-6.6 to 2.9

m/yr = meters per year

As reflected in the table, the range of shoreline change rates can be highly variable even within a geomorphological region. This variability is typically associated with interrupted longshore transport at navigation jetties, where sediment accumulates on the updrift side and leaves a deficit on the downdrift side. Given the long-term monitoring, impacts associated with a singular tropical event that could induce large impacts on the landscape are averaged out. Given this, the Texas coast shows a consistent trend of shoreline erosion. Erosion persists, or accretion is minimal, even though the longshore convergence zone which indicates a degree of sediment loss from the littoral system through a variety of mechanisms including navigation channel dredging, eolian transport to the bays, and cross-shore transport.

2.4 **TIDAL DATUM AND RELATIVE SEA LEVEL CHANGE SCENARIO**

2.4.1 **Relative Sea Level Change (RSLC)**

This study uses current USACE guidance to assess relative sea-level change (RSLC). Current USACE guidance ER 1100-2-8162, December 2013, and ETL 1100-2-1, June 2014, specifies the procedures for incorporating climate change and RSLC into planning studies and engineering design projects. Projects must consider alternatives that are formulated and evaluated for the entire range of possible future rates of RSLC for both existing and proposed projects. USACE guidance specifies evaluating alternatives using “low,” “intermediate,” and “high” rates of future RSLC as follows:

- **Low:** The “low” rate projects future local mean sea level (LMSL) as an extrapolation of the historic rate. Guidance states that historic rates of SLC are best determined by local tide records, preferably with at least a 40-year data record.
- **Intermediate:** The “intermediate” rate of local mean sea-level change is estimated using the modified National Research Council Curve I. It is corrected for the local rate of vertical land movement.
- **High:** The “high” rate of local mean sea-level change is estimated using the modified National Research Council Curve III. It is corrected for the local rate of vertical land movement.

USACE (ETL 1100-2-1, 2014) recommends an expansive approach to considering and incorporating RSLC into civil works projects. It is important to understand the difference between the period of analysis (POA) and planning horizon. Initially, USACE projects are justified over a POA, typically 50 years. However, USACE projects can remain in service much longer than the POA. The climate for which the project was designed can change over the full lifetime of a project to the extent that stability, maintenance, and operations may be impacted, possibly with serious consequences, but also potentially with beneficial consequences. Given these factors, the project planning horizon (not to be confused with the economic POA) should be 100 years, consistent with ER 1110-2-8159. Current guidance

considers both short-term and long-term planning horizons and helps to better quantify RSLC. RSLC must be included in plan formulation and the economic analysis, along with expectations of climate change and RSLC, and their impacts. Some key expectations include:

- At minimum, 20-year, 50-year, and 100-year planning horizons should be considered in the analysis.
- A thorough physical understanding of the project area and purpose is required to effectively assess the projects sensitivity to RSLC.
- RSLCs should be incorporated into models at the mean and extreme events.

2.4.2 **Historical RSLC**

Historical water-level data was obtained from the CO-OPS at the NOAA, which has been measuring sea level for over 150 years. Changes in mean sea level (MSL) have been computed using a minimum 30-year span of observations at each location. These measurements have been averaged by month to eliminate the effect of higher frequency phenomena such as storm surge, in order to compute an accurate linear sea-level trend.

The MSL trends presented are local relative trends as opposed to the global (eustatic) sea-level trend, i.e., LMSL. Tide gauge measurements are made with respect to a local fixed reference level on land; therefore, if there is some long-term vertical land motion occurring at that location, the relative MSL trend measured there is a combination of the global sea-level rate and the local vertical land motion, also known as RSLC.

There are six tide gauges in the coastal region of Texas with a record length of 40 years or more (Table 2-6). These gauge locations are shown on Figure 2-8. The tide gauges at Galveston Pleasure Pier and Freeport are inactive, and the gauges at Freeport and Port Mansfield do not have geodetic data. The remaining gauges are active, have geodetic data, and relatively longer records (and hence tighter confidence bounds on the historical RSLC rate computed from the data). The tide gauges have been assigned to the study regions as follows:

- Region 1 – use the gauge at Galveston Pier 21
- Region 2 – use the gauge at Rockport
- Region 3 – use the gauge at Rockport
- Region 4 – use the gauge at Port Isabel

Table 2-6: NOAA Tide Gauges in Coastal Texas with Greater than 40 Years of Data

Station	RSLC (feet per year)	Data (years)	Status	Datum
Galveston Pier 21	+0.02096	106	Active	Tidal/Geodetic
Galveston Pleasure Pier	+0.02244	54	Inactive	Tidal/Geodetic
Freeport	+0.01427	54	Inactive	Tidal
Rockport	+0.01693	77	Active	Tidal/Geodetic
Port Mansfield	+0.00633	51	Active	Tidal
Port Isabel	+0.01194	70	Active	Tidal/Geodetic

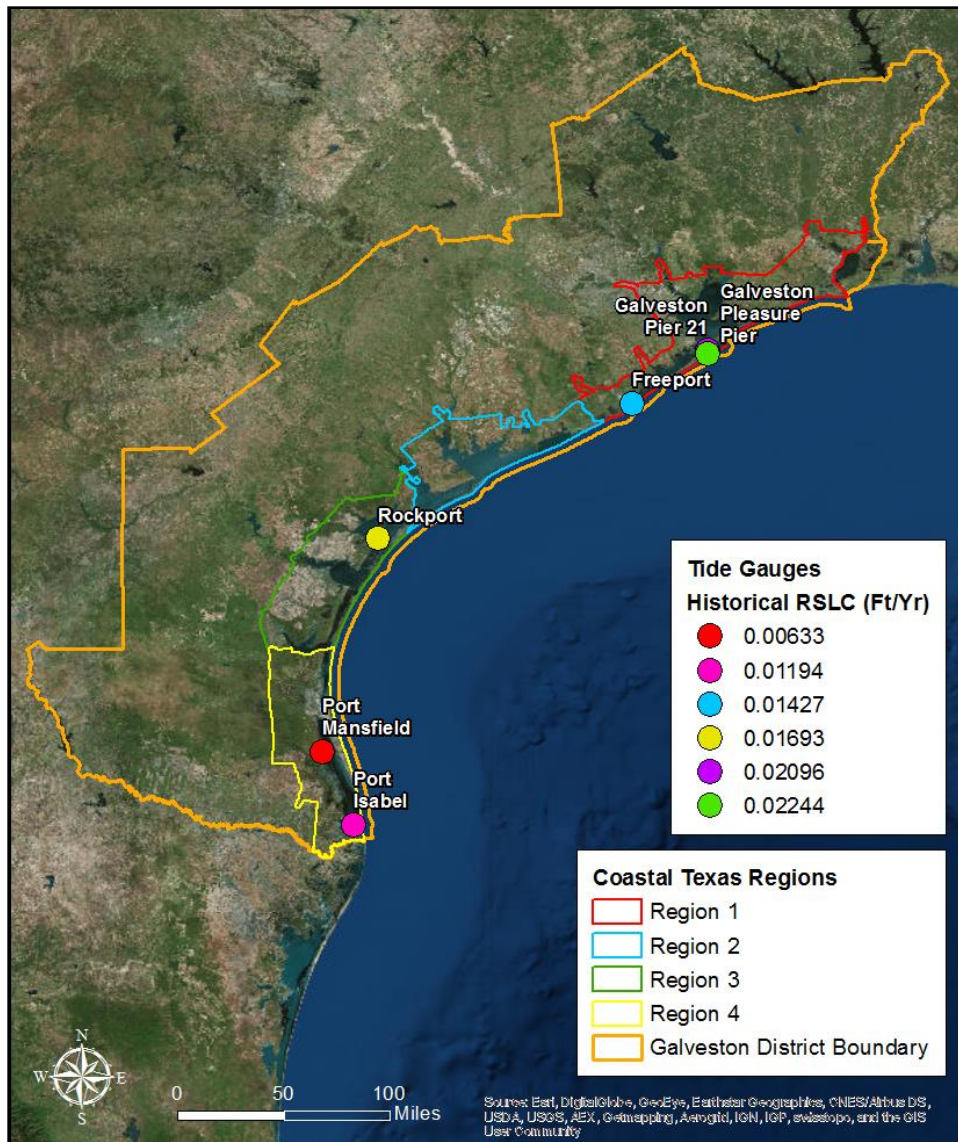

Figure 2-8: Tide Gauge Location Map

Along the Texas coast, RSLC variability is mainly due to ground settlement from compaction of soft ocean sediment. RSLC in Galveston Bay, as measured by the station at Pier 21, is about two times higher than elsewhere on the Texas Coast. But this high rate should be contextualized. Researchers at Texas A&M University have found that within Galveston Bay, there are drastically different subsidence rates across the bay and the ground is sinking fastest in areas where ocean sediment is thickest. A particular area of thick ocean sediment sits directly below the Pier 21 tidal gauge and only covers a small portion of Galveston Bay. This led researchers to the conclusion that sea level is not rising as quickly within all portions of the bay as previously thought.

Figure 2-9 shows the Epoch used in the calculation and conversion between vertical datum in Region 1. All representations of RSLC are presented with respect to LMSL; the datum conversion from LMSL to NAVD 88 is +0.69 foot used in Region 1. Figure 2-10 shows the MSL trend of 2.1 feet per 100 year (0.021 foot/year) combining subsidence and eustatic trend. Figure 2-11 shows RSLC at Pier 21 using USACE 2013 and NOAA 2017 rates. Note that USACE 2013 RSLC Intermediate scenario matches with the NOAA 2017 Intermediate Low curve, whereas, NOAA 2017 Intermediate median curve (green) considers a higher acceleration rate. Figure 2-12 shows the RSLC projections at Galveston Pier 21 gauge from year 1992 (Epoch 1983–2001) to year 2100 using the USACE Sea Level Rise calculator (http://corpsmapu.usace.army.mil/rccinfo/slc/slcc_calc.html).

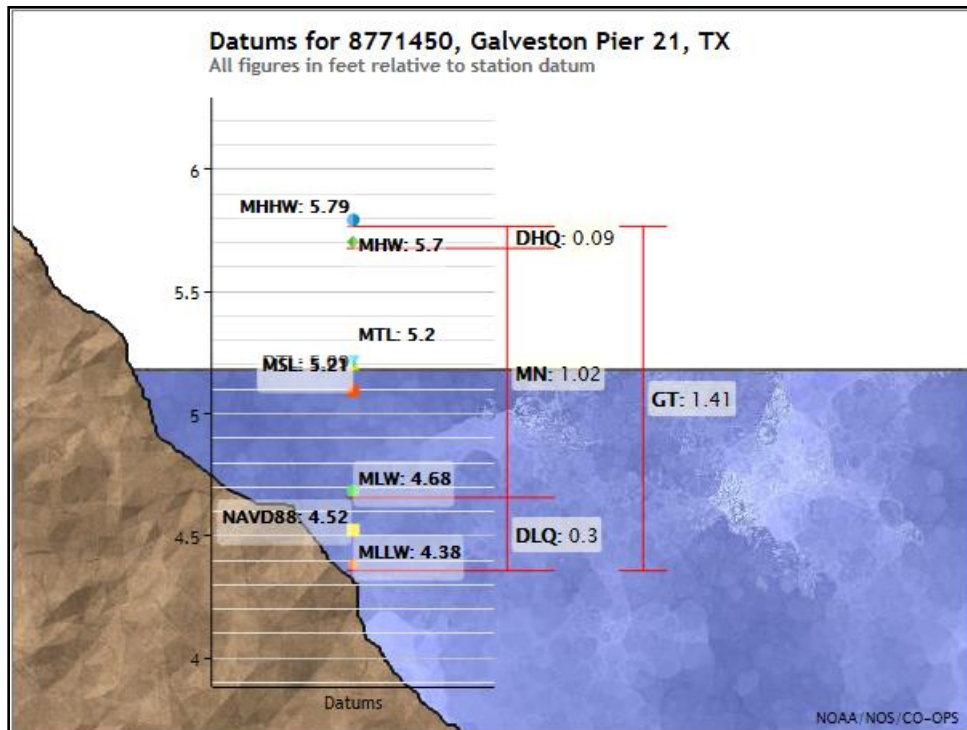

Figure 2-9: Datum for Galveston Pier 21 (Epoch 1983–2001), Revised and Accepted April 17, 2003

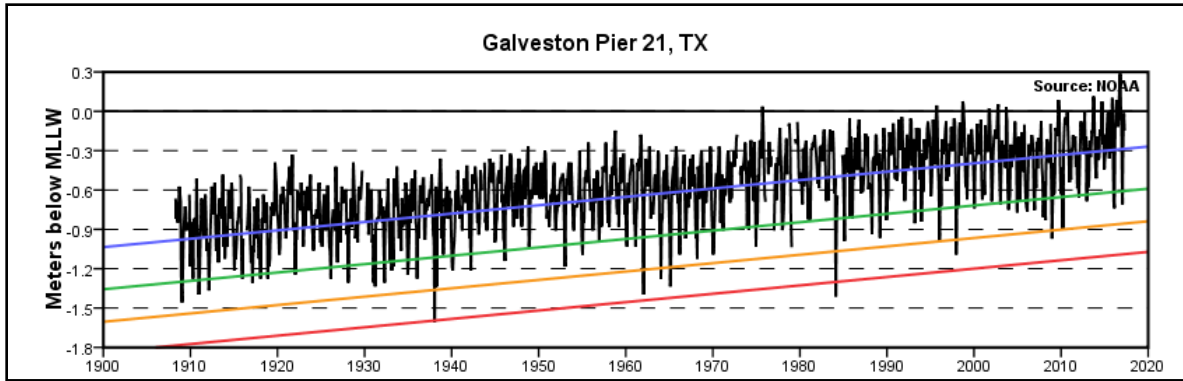

Figure 2-10: Historic LMSL trend of 2.1 Feet per 100-year (0.021 foot/year) Combining Subsidence and Eustatic Trend

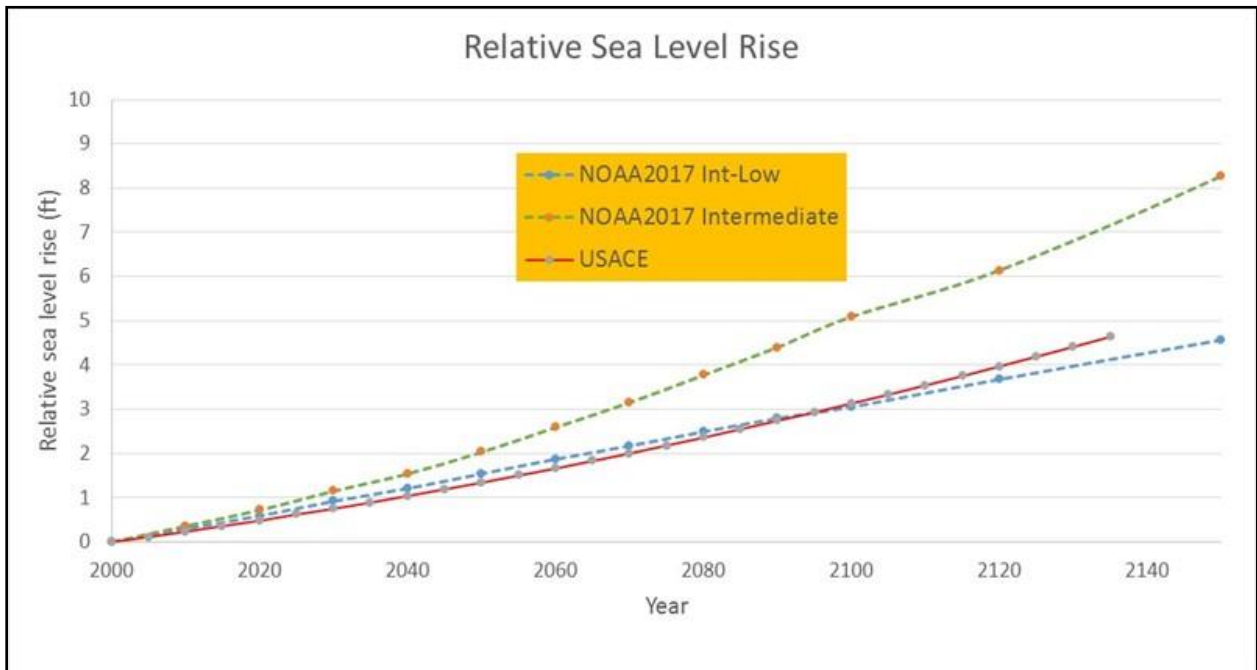

Figure 2-11: Relative Sea Level Rise at Pier 21 Using USACE and NOAA Rates

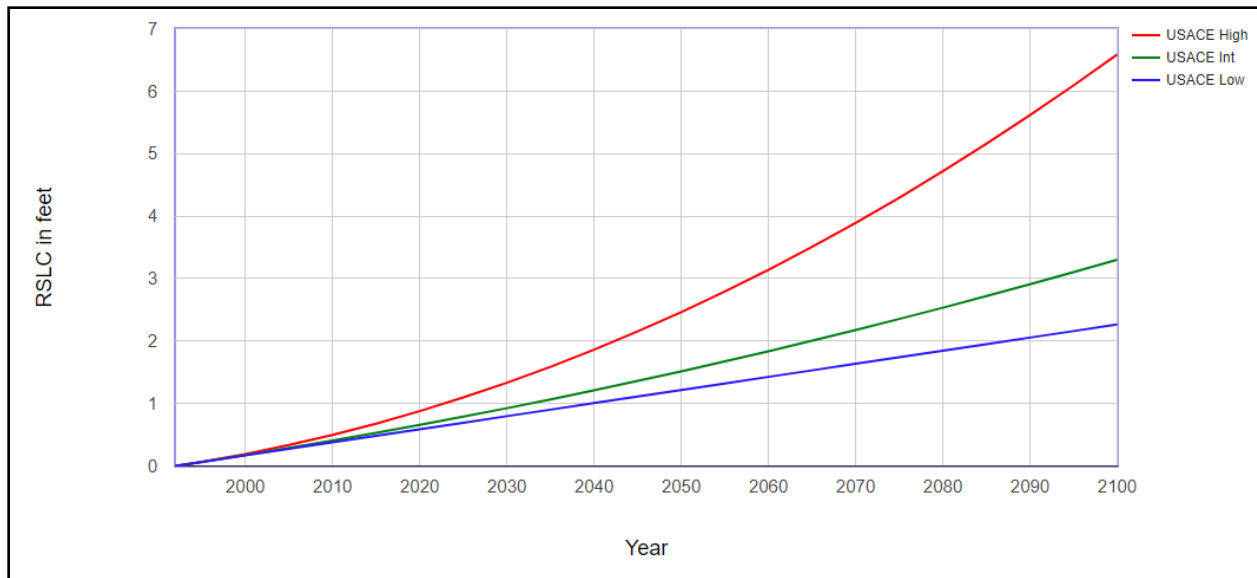

Figure 2-12: Relative Sea Level Change Projections from Year 1992 (Epoch 1983–2001) to Year 2100 (Galveston Pier 21).

2.4.3 Relative Sea Level Rise Scenario for Present and Future Conditions

To evaluate the impacts of RSLC on future conditions, the following reference years are used:

- Reference year 2017: Existing (Present) Condition
- Reference year 2025: Assume construction begins and environmental impact analysis begins
- Reference year 2035: Assume construction complete (for CSRM and mitigation features, and ER) and project is operating, economic benefits begin
- Reference year 2085: End of POA for economics and environmental
- Reference year 2135: Extended POA for economics

Table 2-7 shows the Relative Sea Level Change (NAVD, feet) at Regions 1-4 using EPOCH 1992. Table 2-8 shows the sea level change values (in ft) at Regions 1-4 from the base year. Here, year 2017 is used as the base year due to geoid adjustment in ADCIRC, explained later in Section 2.6.2. Table 2-8 suggests some variations in sea level changes across different regions where Pier 21 gauge in Region 1 experiences the highest RSLC. Since ADCIRC is a large-scale model, it uses average of 6 tidal datum available in Texas (Table 2-6). These average values are later used to correct local water level using Pier 21 gauge. Probabilistic water levels at a given year with a particular return period under a sea level curve scenario were calculated using linear superposition. It is common practice when assessing water levels in coastal studies to separately consider components, such as storm surge, tide, and RSLC, before combining them through linear superposition to determine the total water level. The use of linear superposition introduces an error due to the complex nonlinear interaction of the water level

components. This error is referred to as the nonlinear residuals (NLR). The nonlinear residuals (Figure 2-13) are added while calculating probabilistic storm surge at a location of interest. Details can be found in Annex 1 (Melby 2020). Thus, for evaluation of local water level for different years (Year 2035, 2085, 2135), numbers shown in yellow in Table 2-8 are used along with Nonlinear Residuals (NLR) to correct still water level used for design and economic analyses. ADH model also uses similar offset. As evident from Table 2-8 for intermediate curve, we expect roughly 2 ft of sea level rise in year 2085 and 4 ft in year 2135 above the present sea level condition.

Model simulations for the Coastal Texas Study (CTXS) used initial water levels corresponding to 3 different sea levels. Two of these water levels were used to evaluate project alternatives. The three levels corresponded to present time, which at the initiation of the CTXS was 2017, and a time in the future of roughly 2085. For the base case, the RSLC plus other sea level adjustments were used to compute the final geoid offset for the model simulations, with data taken from long term NOAA gages. An addition of 0.14 ft was needed to account for the RSLC occurring between 2008 and 2017. This was because the ADCIRC mesh was based on LiDAR from 2008. Besides RSLC, a steric adjustment of 0.39 ft was added to account for regional seasonal variations to sea level primarily due to seasonal water temperature change. Also, an average adjustment of 0.38 ft to convert LMSL to NAVD88 was added. The total RSLC and final geoid offsets for the CSTORM simulations were as follows:

SLC0, Present day (2017): $RSLC\ 2008 - 2017 = 0.14\ ft$

Geoid offset = $0.39\ ft\ steric + (0.38\ ft\ LMSL-NAVD88) + 0.14\ ft = 0.91\ ft$ (rounded to 1 ft)

SLC1, 50 yr Service Life (2035 – 2085), High Curve:

Geoid offset = $1 + 4.92\ ft = 5.92\ ft$ (Includes offset 2008 - 2017)

SLC1 most closely corresponds to high curve from USACE 2013 and matches the intermediate-high curve at 50% confidence from NOAA 2017.

SCL2, 50 yr Service Life (2035 – 2085), Intermediate Curve:

Geoid offset = $1 + 2.46\ ft = 3.46$ (Includes offset 2008 - 2017)

SLC2 most closely corresponds to the intermediate curve from USACE 2013 and intermediate-low curve at 50% confidence from NOAA 2017 (e.g. see internet location https://www.usace.army.mil/corpsclimate/Public_Tools_Dev_by_USACE/sea_level_change/).

The preceding values of RSLC were used as Geoid offsets for the hydrodynamic simulations. For the life cycle simulations of beach morphology change, a service life initiation date of 2035 was used. The life cycles were 50 years in duration, so they extended to year 2085.

Table 2-7: Relative Sea Level Change (NAVD, ft) at Regions 1-4 (Using Epoch 1992)

Year	Pier 21 (Region 1)			Rockport (Regions 2 and 3)			Port Isabel (Region 4)		
	Low	Intermediate	High	Low	Intermediate	High	Low	Intermediate	High
1992	0.69	0.69	0.69	1.13	1.13	1.13	-0.04	-0.04	-0.04
1995	0.75	0.75	0.76	1.18	1.18	1.18	0	0	0
2000	0.86	0.86	0.88	1.26	1.27	1.29	0.06	0.06	0.08
2005	0.96	0.98	1.02	1.35	1.37	1.41	0.12	0.13	0.18
2010	1.07	1.1	1.19	1.44	1.46	1.56	0.18	0.2	0.3
2015	1.17	1.22	1.37	1.52	1.57	1.72	0.24	0.28	0.43
2020	1.28	1.35	1.57	1.6	1.67	1.9	0.29	0.36	0.59
2025	1.38	1.48	1.79	1.69	1.79	2.09	0.35	0.45	0.76
2030	1.49	1.62	2.02	1.77	1.9	2.31	0.41	0.54	0.95
2035	1.59	1.76	2.28	1.86	2.02	2.54	0.47	0.64	1.16
2040	1.7	1.9	2.55	1.94	2.15	2.8	0.53	0.74	1.39
2045	1.8	2.05	2.84	2.03	2.28	3.07	0.59	0.84	1.63
2050	1.91	2.21	3.15	2.11	2.41	3.36	0.65	0.95	1.9
2055	2.01	2.36	3.48	2.2	2.55	3.67	0.71	1.07	2.18
2060	2.12	2.53	3.83	2.28	2.69	4	0.77	1.18	2.49
2065	2.22	2.69	4.2	2.37	2.84	4.34	0.83	1.31	2.81
2070	2.33	2.87	4.58	2.45	2.99	4.71	0.89	1.43	3.15
2075	2.43	3.04	4.98	2.54	3.15	5.09	0.95	1.56	3.51
2080	2.54	3.22	5.41	2.62	3.31	5.49	1.01	1.7	3.88
2085	2.64	3.41	5.85	2.7	3.47	5.91	1.07	1.84	4.28
2090	2.75	3.6	6.31	2.79	3.64	6.35	1.13	1.98	4.69
2095	2.85	3.79	6.78	2.87	3.82	6.81	1.19	2.13	5.12
2100	2.95	3.99	7.28	2.96	4	7.28	1.25	2.29	5.57
2105	3.06	4.19	7.79	3.04	4.18	7.78	1.31	2.44	6.04
2110	3.16	4.4	8.33	3.13	4.37	8.29	1.37	2.61	6.53
2115	3.27	4.61	8.88	3.21	4.56	8.82	1.43	2.77	7.04
2120	3.37	4.83	9.45	3.3	4.75	9.37	1.49	2.95	7.56
2125	3.48	5.05	10.04	3.38	4.95	9.94	1.55	3.12	8.11
2130	3.58	5.28	10.64	3.47	5.16	10.53	1.61	3.3	8.67
2135	3.69	5.51	11.27	3.55	5.37	11.1	1.67	3.49	9.25

Table 2-8: Relative Sea Level Change (NAVD, ft) at Regions 1-4 (Using Base Year 2017)

Year	Pier 21 (Region 1)			Rockport (Regions 2 and 3)			Port Isabel (Region 4)		
	Low	Intermediate	High	Low	Intermediate	High	Low	Intermediate	High
2017	0	0	0	0	0	0	0	0	0
2020	0.07	0.08	0.12	0.05	0.06	0.11	0.03	0.05	0.1
2025	0.17	0.21	0.34	0.14	0.18	0.3	0.09	0.14	0.27
2030	0.28	0.35	0.57	0.22	0.29	0.52	0.15	0.23	0.46
2035	0.38	0.49	0.83	0.31	0.41	0.75	0.21	0.33	0.67
2040	0.49	0.63	1.1	0.39	0.54	1.01	0.27	0.43	0.9
2045	0.59	0.78	1.39	0.48	0.67	1.28	0.33	0.53	1.14
2050	0.7	0.94	1.7	0.56	0.8	1.57	0.39	0.64	1.41
2055	0.8	1.09	2.03	0.65	0.94	1.88	0.45	0.76	1.69
2060	0.91	1.26	2.38	0.73	1.08	2.21	0.51	0.87	2
2065	1.01	1.42	2.75	0.82	1.23	2.55	0.57	1	2.32
2070	1.12	1.6	3.13	0.9	1.38	2.92	0.63	1.12	2.66
2075	1.22	1.77	3.53	0.99	1.54	3.3	0.69	1.25	3.02
2080	1.33	1.95	3.96	1.07	1.7	3.7	0.75	1.39	3.39
2085	1.43	2.14	4.4	1.15	1.86	4.12	0.81	1.53	3.79
2090	1.54	2.33	4.86	1.24	2.03	4.56	0.87	1.67	4.2
2095	1.64	2.52	5.33	1.32	2.21	5.02	0.93	1.82	4.63
2100	1.74	2.72	5.83	1.41	2.39	5.49	0.99	1.98	5.08
2105	1.85	2.92	6.34	1.49	2.57	5.99	1.05	2.13	5.55
2110	1.95	3.13	6.88	1.58	2.76	6.5	1.11	2.3	6.04
2115	2.06	3.34	7.43	1.66	2.95	7.03	1.17	2.46	6.55
2120	2.16	3.56	8	1.75	3.14	7.58	1.23	2.64	7.07
2125	2.27	3.78	8.59	1.83	3.34	8.15	1.29	2.81	7.62
2130	2.37	4.01	9.19	1.92	3.55	8.74	1.35	2.99	8.18
2135	2.48	4.24	9.82	2	3.76	9.34	1.41	3.18	8.76

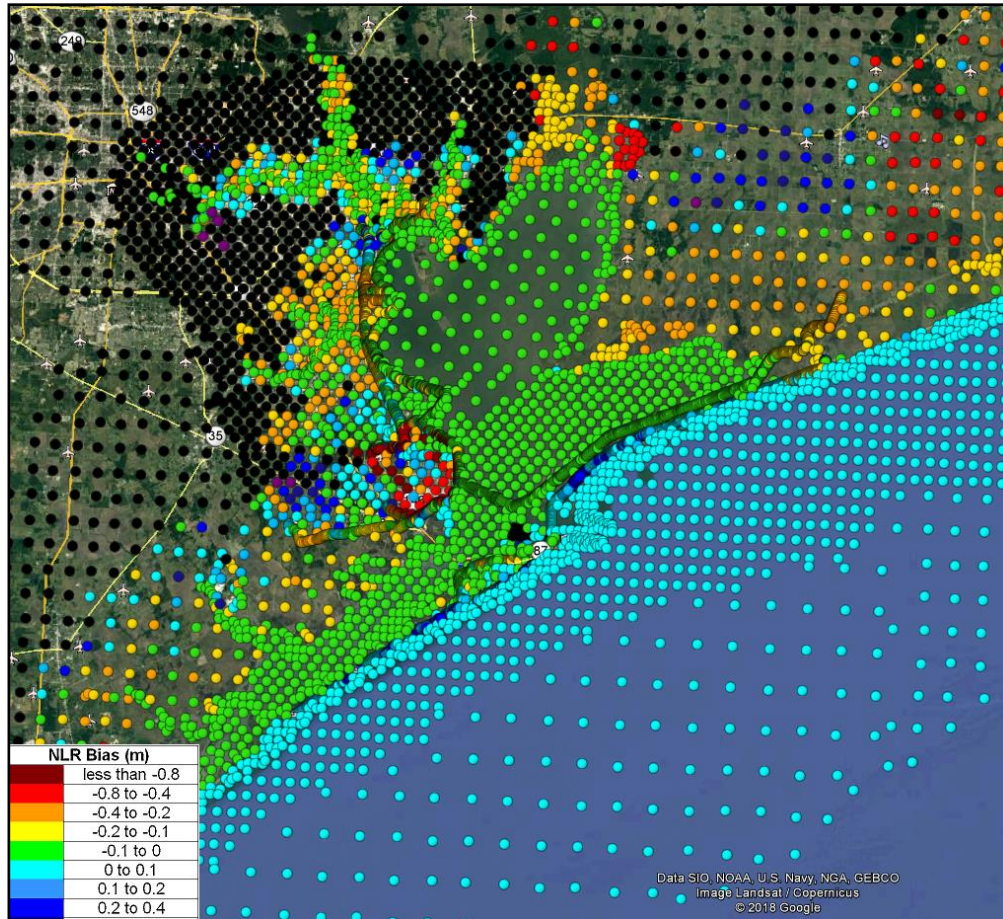

Figure 2-13: Distribution of Nonlinear Residuals in Superposition of Sea Level Rise

The NOAA Sea Level Rise and Coastal Flooding Impacts Viewer was used to visualize the impact of RSLC (Figure 2-14). For example, at a 2-foot rise in sea level, the centerline of Bolivar Peninsula west of Rollover Bay remains above water. This model suggests that the majority of Galveston County would be unaffected.

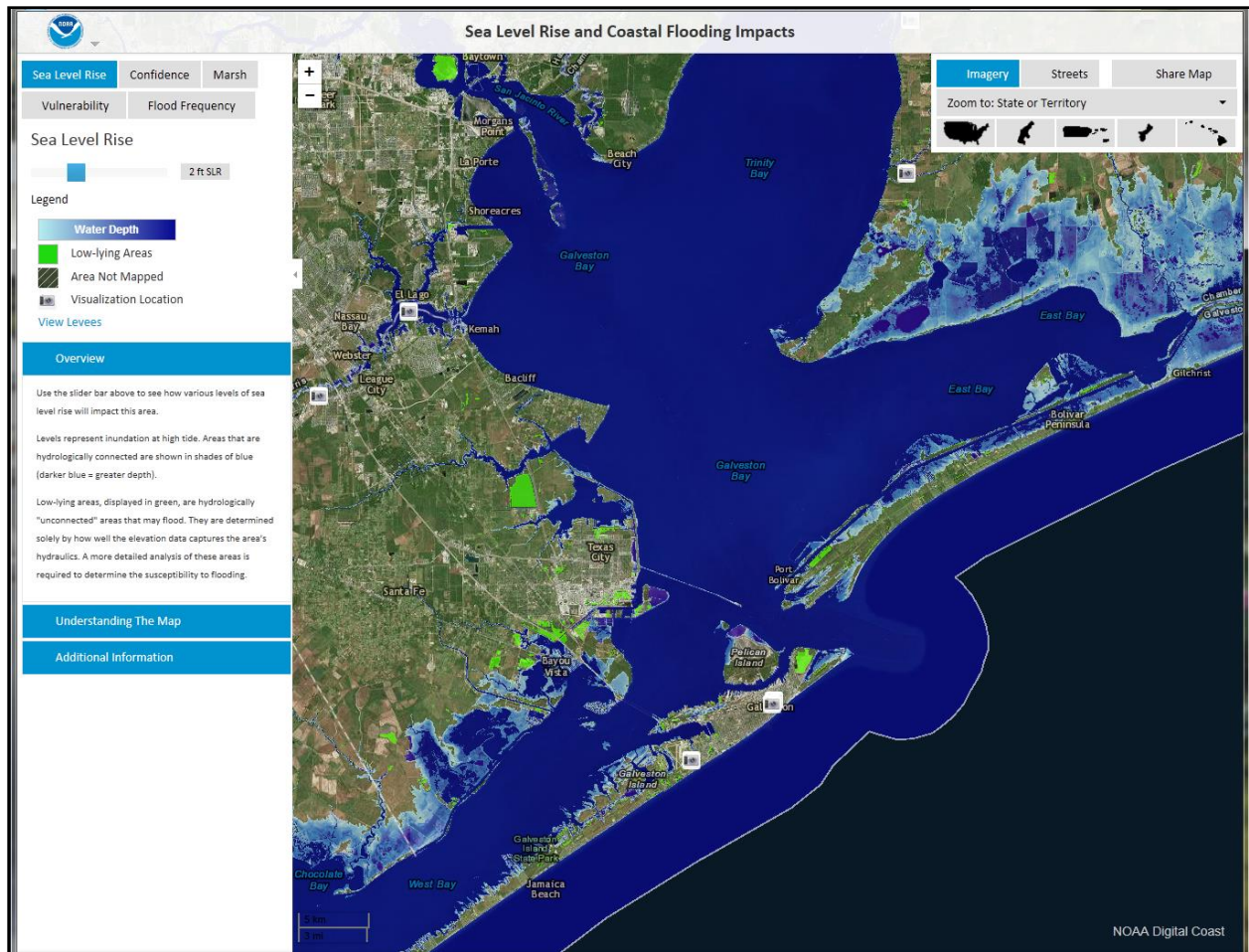

Figure 2-14: Extent of Inundation at Galveston, Texas with 2-foot Sea Level Rise Scenario from Present Condition

2.5 COASTAL STORM MODEL SIMULATIONS

For the Coastal Texas Study, the Advanced Circulation (ADCIRC) model was used to simulate two-dimensional depth-integrated surge and circulation responses to the storm conditions. The simulations for the full Coastal Texas study used initial water levels corresponding to 3 different sea levels. Two of these water levels were used to evaluate project alternatives. The three levels corresponded to present time, which at the initiation of the Coastal Texas Study feasibility work in 2017, and a time in the future of roughly 2085. The two distant in time RSLCs were 1.5 m (4.92 ft) for the high and 0.75 m (2.46 ft) for the intermediate, chosen somewhat arbitrarily because the details of the economic life had not been resolved when the simulations were done initially in 2017. Note that, these values are very similar to the RSLC values shown in Table 2-8. More details on each of the numerical models, sample validation results and a description of how they were applied to the Coastal Texas Study can be found in Annex1 (Melby, 2020).

2.5.1 Example Model Results: Without Project

Under the without-project conditions, 660 synthetic tropical storm conditions were used in conjunction with three different starting water levels to compute storm surge and nearshore wave conditions using coupled ADCIRC+STWAVE simulations.

With almost 2,000 model simulations performed for without-project conditions, it is impossible to show even a fraction of all the results in this report. Instead, maximum storm surge results from one example storm are shown. The example storm is Synthetic Tropical Storm #342, which had a maximum radius of maximum winds of 54.1 nautical miles, a minimum central pressure of 915 millibar, and a forward translational speed of 12.9 knots. Maximum wind speeds reached 109 mph, and as such it was classified as a Category 2 hurricane on the Saffir-Simpson hurricane wind scale. Landfall occurred around Freeport, Texas, with about a 60° angle of attack to the coastline. An image showing the storm track is given on Figure 2-15. Figure 2-16 shows a map of maximum surge elevation based on the current sea level rise scenario. Notice that surge in the bay is above 18 feet, with the exception of Texas City, which is protected by the existing Texas City Dike system.

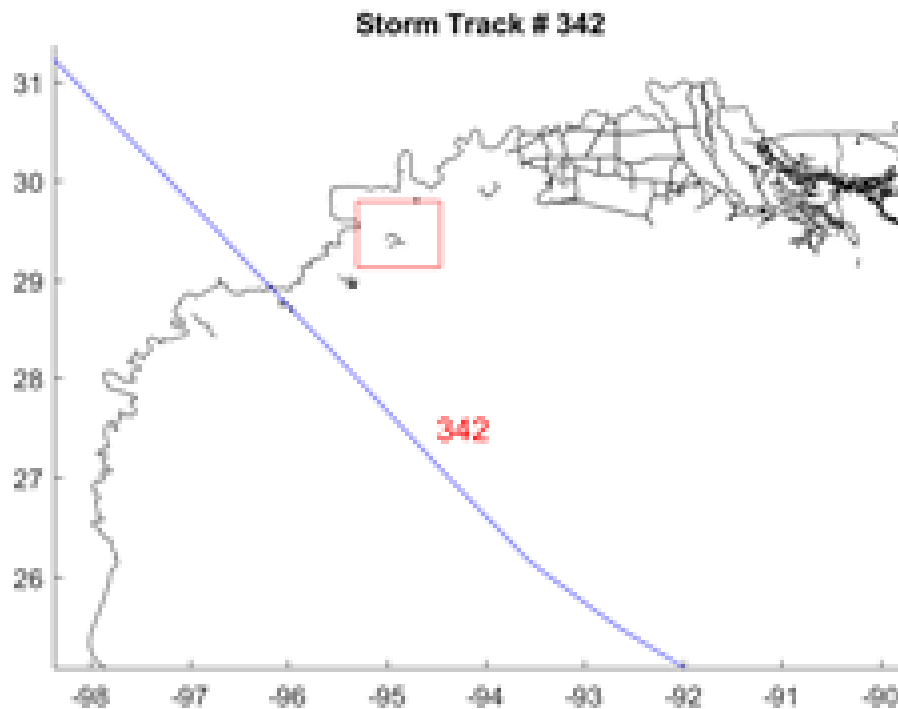

Figure 2-15: Track Time History for Tropical Synthetic Storm Number 342

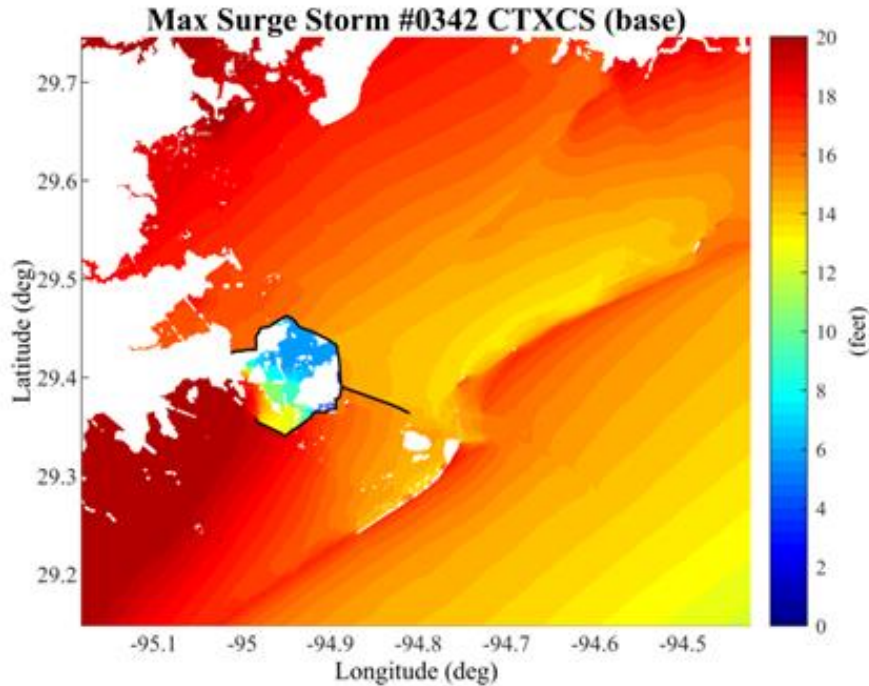

Figure 2-16: Maximum Surge Elevation from Storm #342 (Without Project)

2.5.2 Example Model Results: With-Project

Under the with-project conditions (Recommended Plan), 170 synthetic tropical storm conditions were run with two different starting water levels to compute storm surge and nearshore wave conditions. Details of these configurations are described in Section 4. With Project ADCIRC and STWAVE modeling grid includes:

- A 2-mile long Storm Surge barrier at Bolivar Roads across the entrance to the Houston Ship Channel, between Bolivar Peninsula and Galveston Island with elevation of 21.5 ft NAVD 88;
- 43 miles of Dune and Berm segments on Bolivar Peninsula and West Galveston Island with average elevation of 12 ft NAVD 88. Note that although dune field systems are designed at 14 ft NAVD 88, for ADCIRC simulations, 12 ft has been used due to taking a conservative approach that dune wash over may happen well before SWL reaches crest height.
- 18-mile ring barrier system around Galveston city with elevation of 14 ft NAVD 88.
- Modification of the existing 10-mile seawall to provide an additional 2-3 feet of storm surge overtopping defense. Elevations are set at 21 ft NAVD 88.
- 2 smaller navigation gates at Clear Lake and Dickinson Bay with elevations of 17 and 18 ft NAVD 88.

Alignments of the with project alternative evaluated herein are shown in Figure 2-17. All wave and water level modeling for the with project alternative considers closed surge barrier/navigation gate at Bolivar Roads (Galveston Entrance Channel). For with-project alternative, the ADCIRC mesh was altered to include the flood protection design specifications, namely in the form of levees which are represented in the ADCIRC model as weir-pairs and morphological changes such as dune and beach features. Levee features are included in STWAVE as depth features. As shown in Figure 2-17, the bright green lines represent the with-project features, including the gate surge barrier, the beach-dune system, the ring barrier around the back side of Galveston Island and two smaller navigation gates, one at Dickinson Bay and the other at Clear Lake.



Figure 2-17: With-project Condition (The Recommended Plan)

Similar to the without project condition, storm surge results are presented on a single example storm, Storm #342. Figure 2-18 shows a map of maximum surge elevation for the with-project scenario, which shows significant reduction (> 50%) of surge in Galveston Bay when compared with the without project condition. Due to the ring barrier system, Galveston City remains mostly dry. Figure 2-19 shows the difference map between the without project condition and the with-project condition. From this figure, it can be inferred that depending on the location, storm surge barrier system can reduce water level anywhere between 6 to 15 ft demonstrating the effectiveness of the Recommended Plan. The amount of storm surge reduction, however, varies depending on the orientation of storm tracks, landfall location and storm intensity. Examples of other storms can be found in Annex 1.

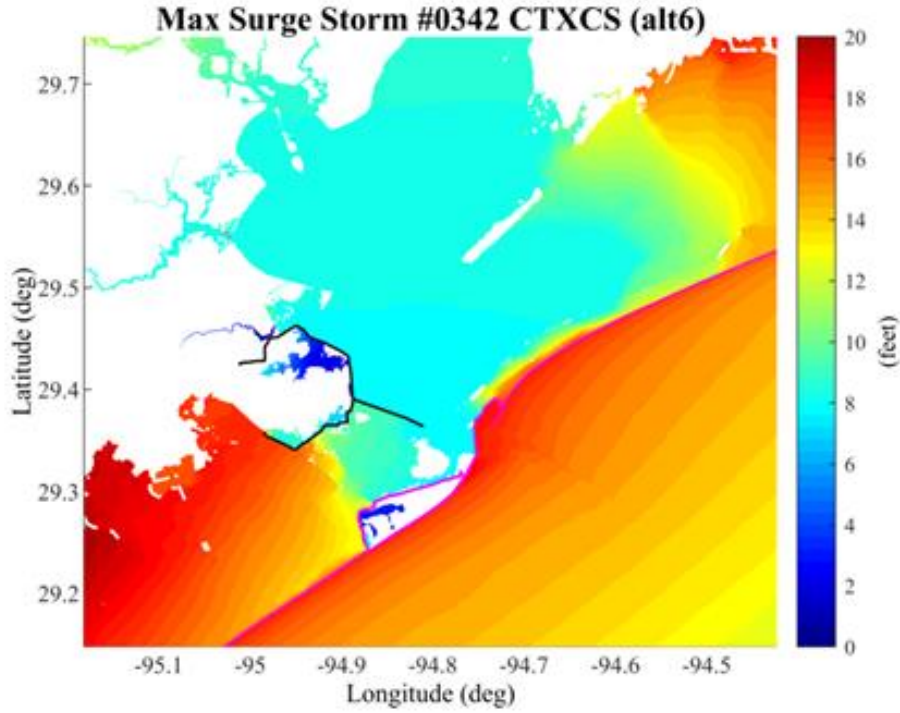

Figure 2-18: Maximum Surge Elevation from Storm Number 342 (With Project)

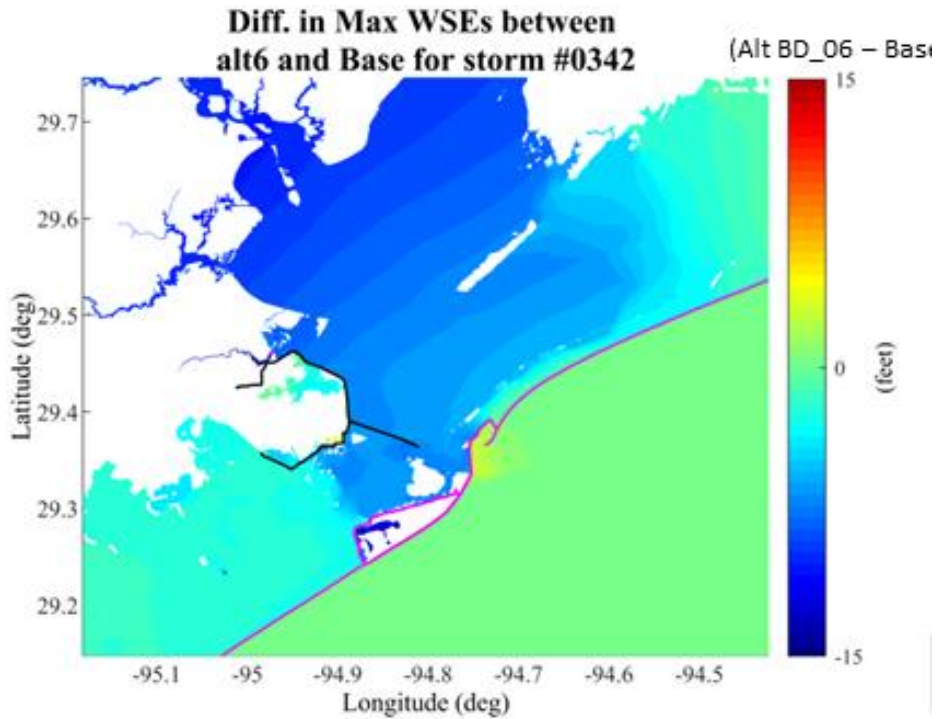

Figure 2-19 : Difference in SWL for Storm 342 Under Without-Project and With-Project Condition.

2.6 **DISCUSSION OF STORM SURGE WITH PROJECT ALTERNATIVE ALIGNMENTS**

2.6.1 **With Project Storm Surge Reduction (Individual Storm)**

This section presents time series comparisons of water surface elevations for four alternative conditions evaluated: without-project, gate only (BD Alt2), the gate, beach-dune and ring barrier with navigation gates at Clear Lake and Dickinson Bays (BD Alt6), and the gate, beach-dune and ring levee (BD Alt3). Six save point locations are used for this comparison near the Houston Shipping Channel, starting at the mouth of Galveston Bay at the inlet and moving northward through the inlet and stopping near Morgan's Point. See inset Figure 2-20 for a map indicating the location of the points. Each image below contains a side-by-side comparison of water levels on the right-hand side and wind speed, wind direction and surface level atmospheric pressure on the left-hand side. Note that since the winds and pressure do not change significantly from one save point to an adjacent save point, the images on the left-hand side alternate between showing normalized wind vectors over time and a combination of wind speed and atmospheric pressure.

Storm 342, Figure 2-15, is a large sized storm with a relatively slow forward speed, and a maximum wind speed around 109 mph. The track has the storm making landfall south of the project location at an angle nearly perpendicular to the shoreline. This type of track angle and landfall location in proximity to the project area is where the with-project conditions show significant reductions in water levels at each of the save points along Galveston Bay. From Figure 2-20, we observe that without-project water levels at the northern most save point, 15854, are approximately 18 feet at the peak, while the full project BD Alt 6 has a peak water level of about 8 feet, the gate-only option, BD Alt 2, has a peak water level of about 12 feet at the same save point. Characteristics of other storms can be found in Annex1.

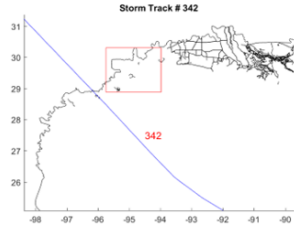

Storm #0342

Max. Wind Speed: 109 mph (Cat. 2)
 Min. Cp: 915 mb
 Rmax: 54.1 nm
 Forward Speed: 12.9 kts

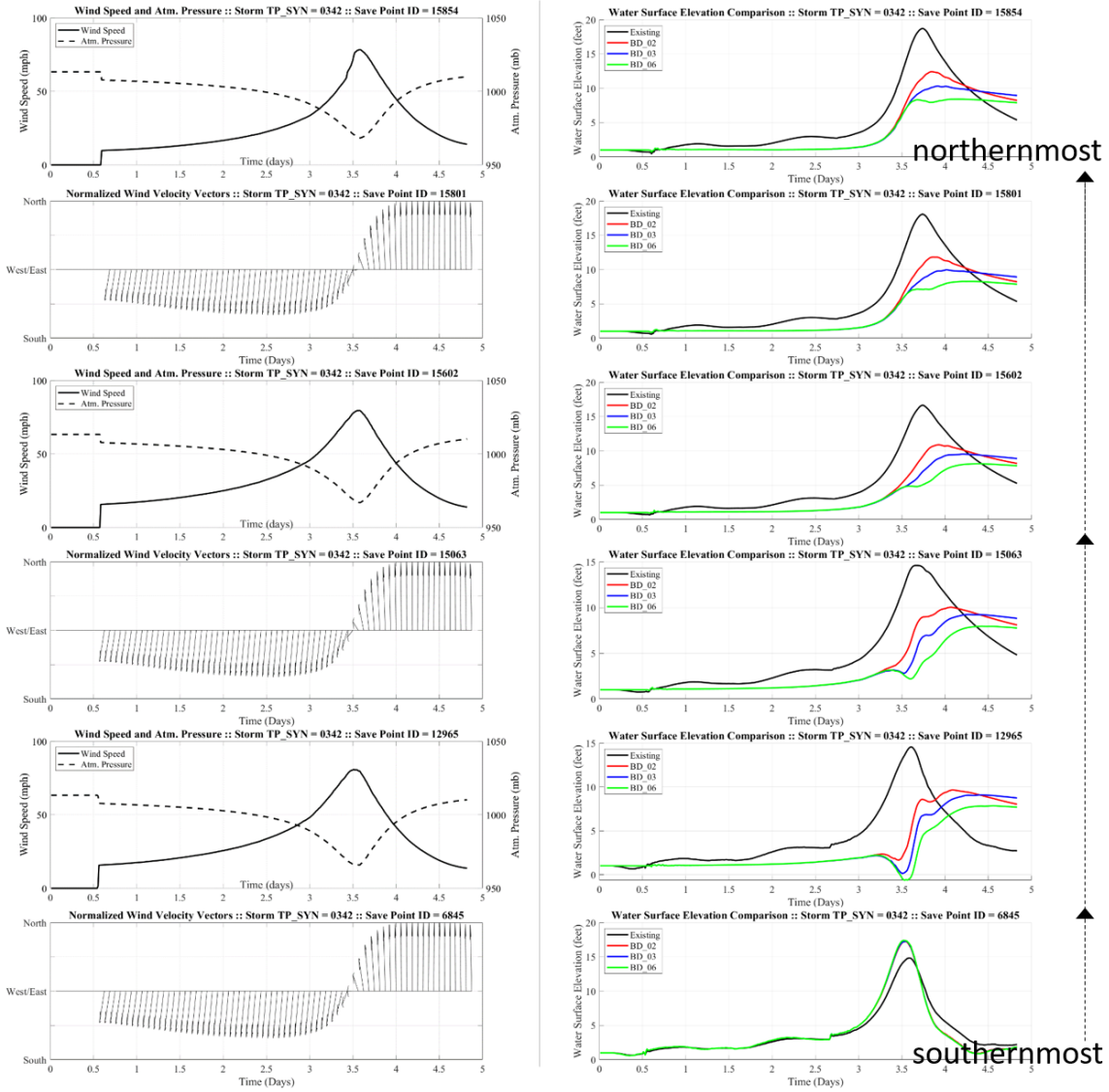
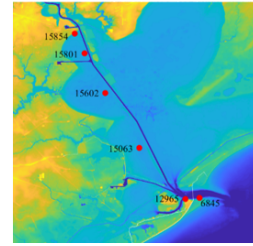

Figure 2-20: Comparison of water surface elevation for storm 342 (right hand side) at six (6) save point locations for four (4) different configurations. The left hand side shows the corresponding wind direction (as normalized vectors), wind speed and atmospheric pressure

2.6.2 Probabilistic Modeling of Storm Surge (Point Hazard Curves)

The probability mass surfaces were computed for without-project and with-project alternatives for each RSLC scenario using the exceedance distributions for 18332 save points for the simulated storms resulting in accurate storm probability masses. The probability masses were used with the individual storm peaks to develop hazard curves for both Still Water Level and Waves for all save points using Joint Probability Analyses (JPA) and including uncertainty. The uncertainty that is incorporated in this analysis is discussed in Melby 2020.

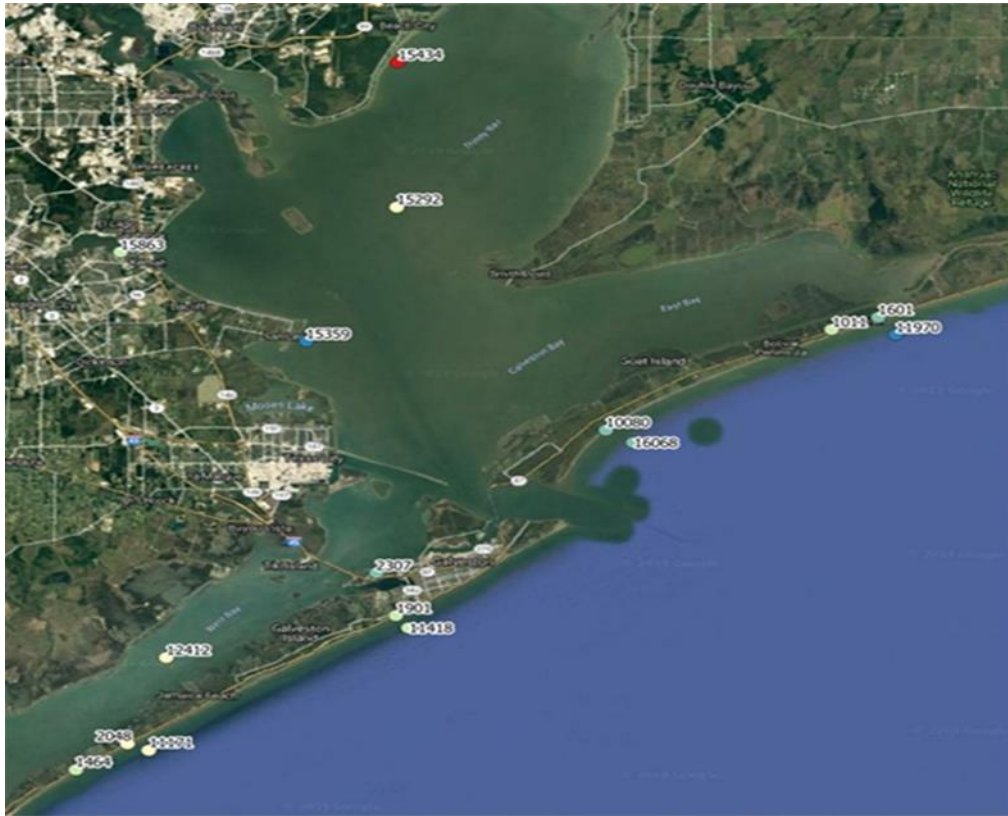

Figure 2-21: Location Map of Example Observation Stations

Error! Reference source not found. shows the location map of example observation stations where hazard curves are illustrated in this section. Figure 2-22 shows without-project hazard curves at 90% Confidence Interval (CI), Present RSLC Condition (SLC0 Scenario) at 3 stations representing offshore Galveston, West Bay and mid-Galveston Bay. Without considering sea level rise (SLC0), 1% Annual Exceedance Probability (AEP) still water level (100-year return period) varies between 14.5 to 16.5 ft (NAVD 88 Datum). Same for 0.2% AEP still water level (500-year return period) varies between 22 to 24 ft (NAVD 88 Datum).

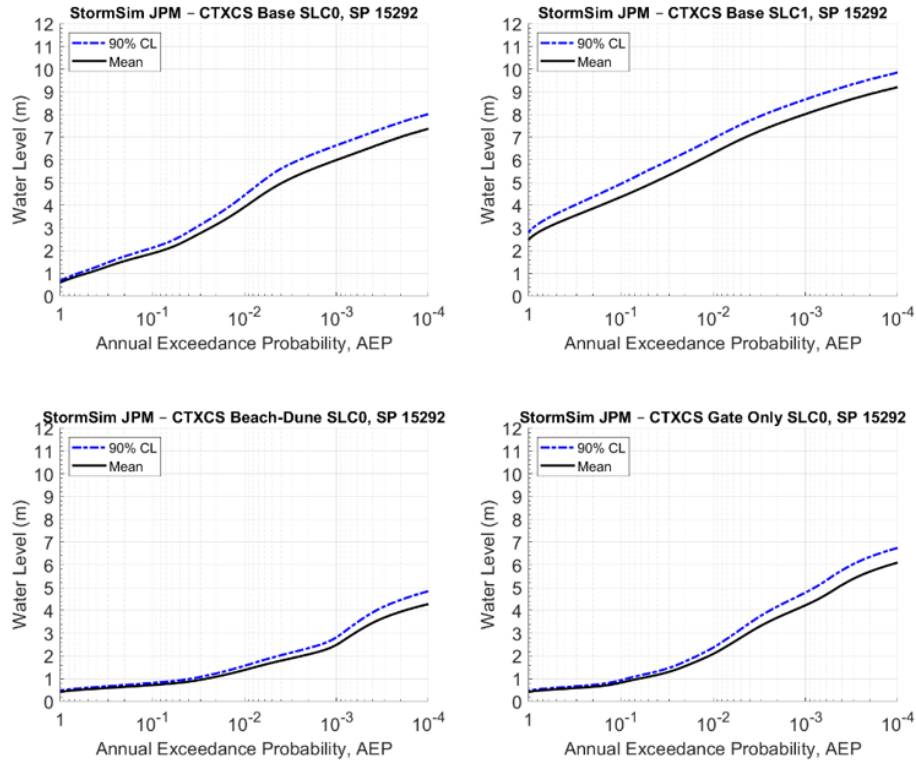

Figure 2-23 and

Figure 2-24 show examples of SWL hazard curves for different alternatives and RSLC scenario, with the mean (50% CI) and 90% CI. Figure 2-23 shows SWL at Clear Lake area (SP 15863) for without-project conditions for two RSLC conditions (SLC0 & SLC1). This figure also shows two with-project alternative conditions with SLC0 representing just gate only option and full project scenario that includes Bolivar Gate, Beach and Dune system along with Clear Lake and Dickinson Bay Gates. Figure 2-24 shows SWL at Galveston Mid Bay (SP 15292) for without-project conditions for two RSLC conditions (SLC0 & SLC1). This figure also shows two with-project alternative conditions with SLC0 representing just gate only option and full project scenario that includes Bolivar Gate, Beach and Dune system along with Clear Lake and Dickinson Bay Gates. Table 2-9 summarizes 1% AEP Still Water Level at 90% CI at these points showing significant SWL reduction with the alternative scenarios.

Table 2-9: 1% AEP Still Water Level (NAVD 88 meter) at representative points

Save Points	SWL (NAVD88 m) Without Project (SLC0)	SWL (NAVD88 m) Without Project (SLC1)	SWL (NAVD88 m) Gate Only (SLC0)	SWL (NAVD88 m) Full Project (SLC0)
SP 15863	5.0	7.2	3.5	2.0
SP 15292	4.5	7.0	2.2	1.5

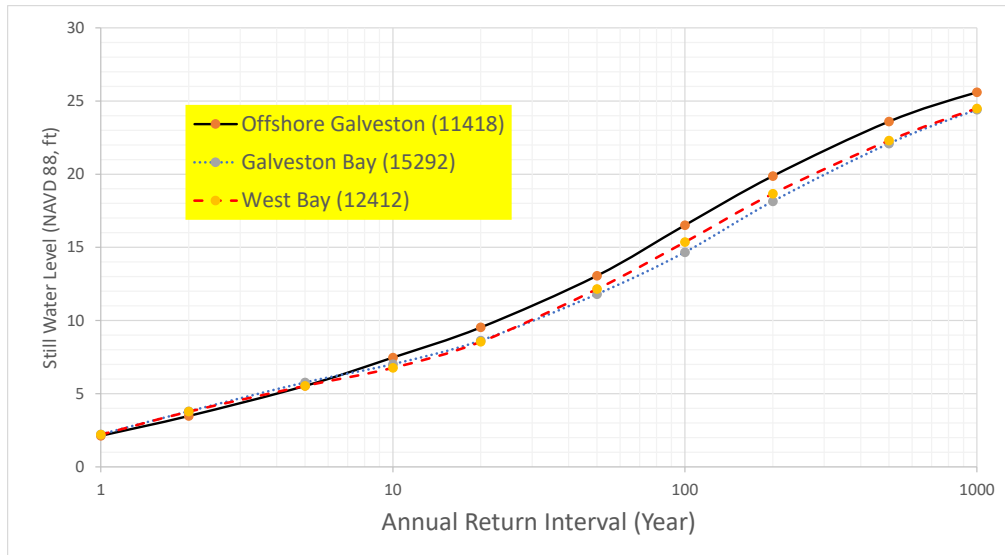

Figure 2-22: Hazard curves at 90% Confidence Interval (CI) at representative stations (Present RSLC scenario- SLC0 condition)

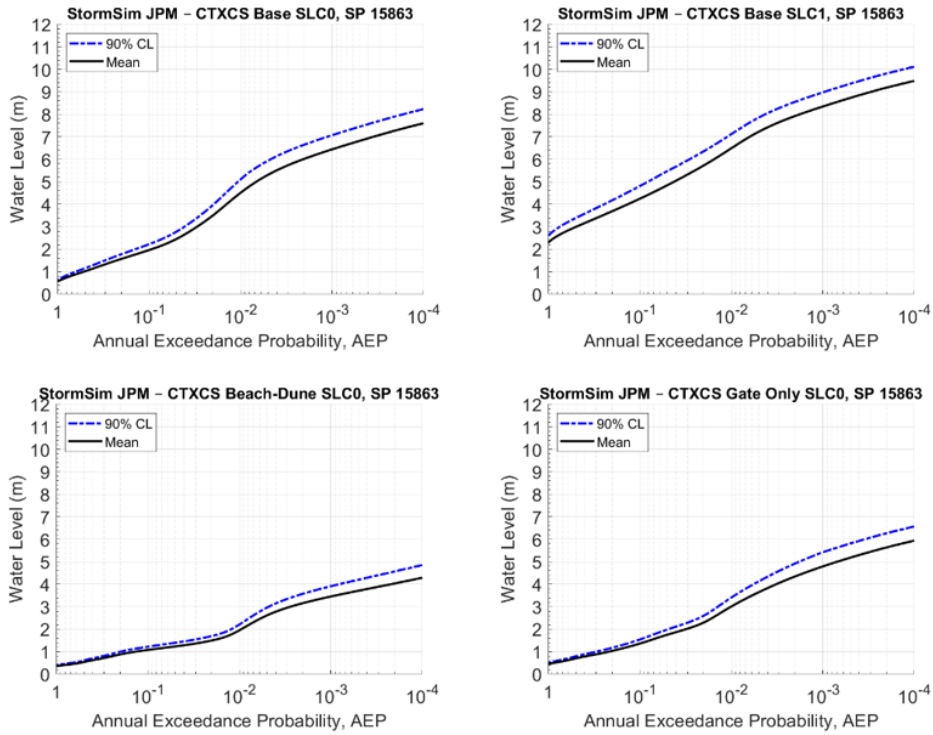

Figure 2-23: Hazard curves for 4 scenarios for SP 15863 (Clear Lake Area)

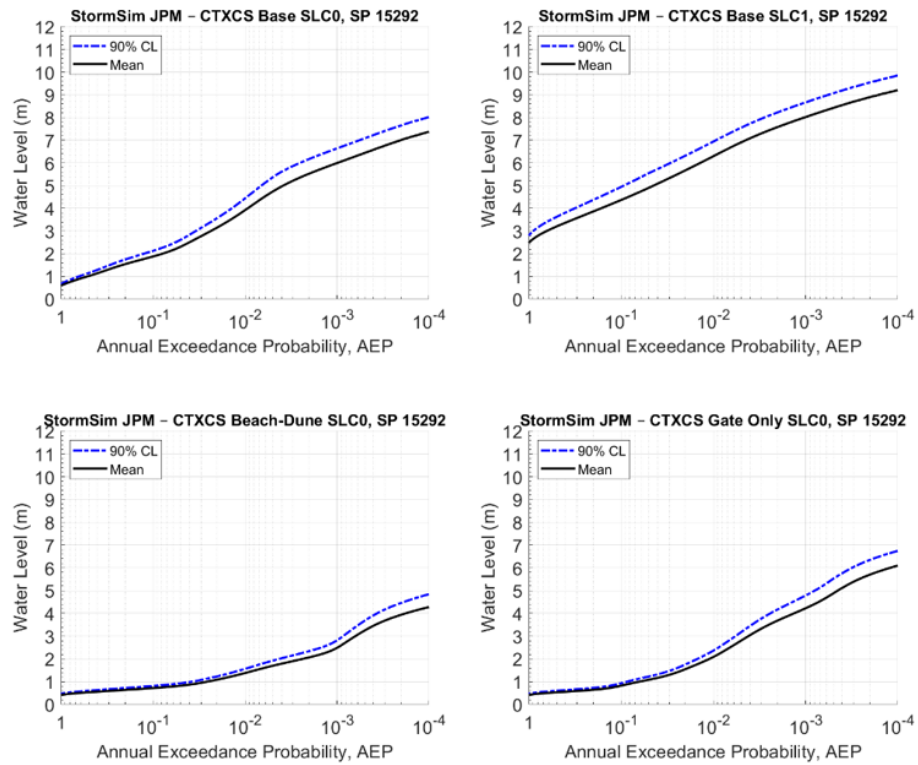

Figure 2-24: Hazard curves for 4 scenarios for SP 15292 (Galveston Mid Bay)

2.6.3 Probabilistic Modeling of Storm Surge (Hazard Surface)

As stated earlier, the probability mass surfaces were computed for without-project and with-project alternatives for each RSLC scenario (SLC0, SLC1, and SLC2) using the exceedance distributions for 18332 CTXS points for the 660 simulated storms. Details can be found in Melby 2020. These 18332 hazard points are later used to generate hazard surfaces for 8 probability events (1-year, 10-year, 20-year, 50-year, 100-year, 200-year, 500-year, and 1000-year return periods) for low, intermediate, and high RSLC conditions for year 2035 and 2085. ADCIRC GEOID Offset discussed in Section 2.4 and using RSLC values in Table 2-8, hazard curves are calculated on these same points with appropriate datum correction using Pier 21 Gauge. These probabilistic hazard surfaces are used for economic analyses projected on a grid and reach network developed by the economic team. For visualization, raster surfaces are also generated using GIS on a 10 ft by 10 ft grid. As an example, without project (WOP) SWL at 1% AEP with 90% CI for year 2035 using intermediate RSLC is presented in Figure 2-25. With project (WP) SWL at 1% AEP with 90% CI for year 2035 using intermediate RSLC is presented in Figure 2-26. Galveston City remains dry showing effectiveness of the ring barrier system. Figure 2-27 shows the 1% AEP SWL difference map which is created by subtracting with-project results from the without-project condition. Here, negative values represent water level reduction, while positive values represent inducements. From Figure 2-27, it is evident that with project in place, depending on location, 1% AEP SWL reduction ranges from 6 to 10 ft where reductions are prominent across the upper bay area. Other surfaces show similar characteristics.

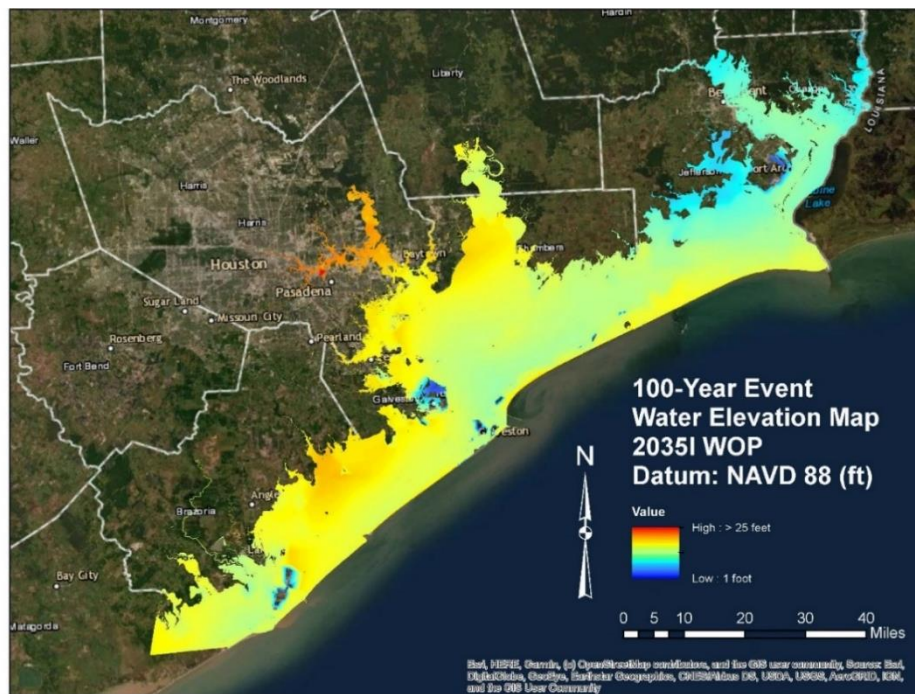

Figure 2-25: 1% AEP SWL (Without Project, Year 2035, Intermediate RSLC)

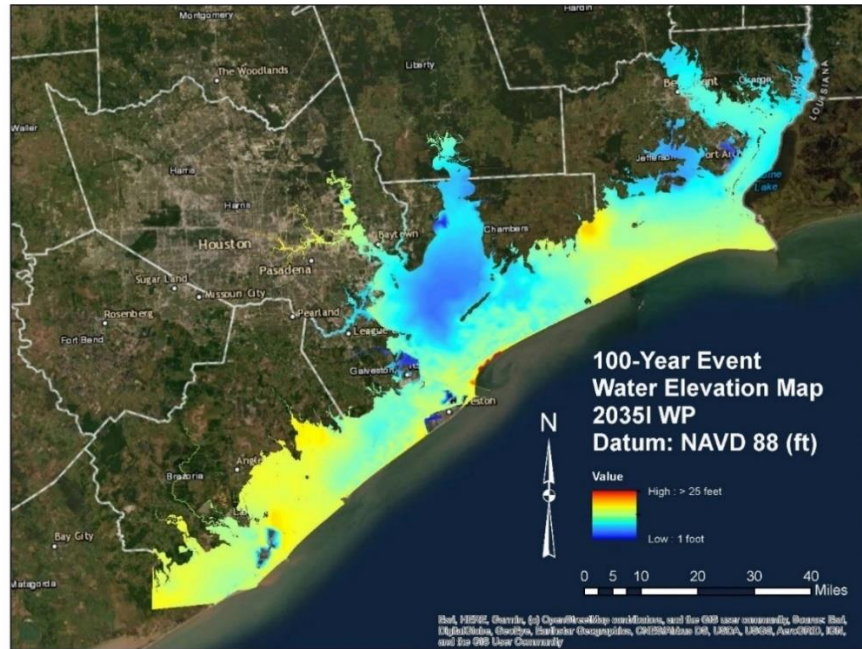

Figure 2-26: 1% AEP SWL (With-Project, Year 2035, Intermediate RSLC)

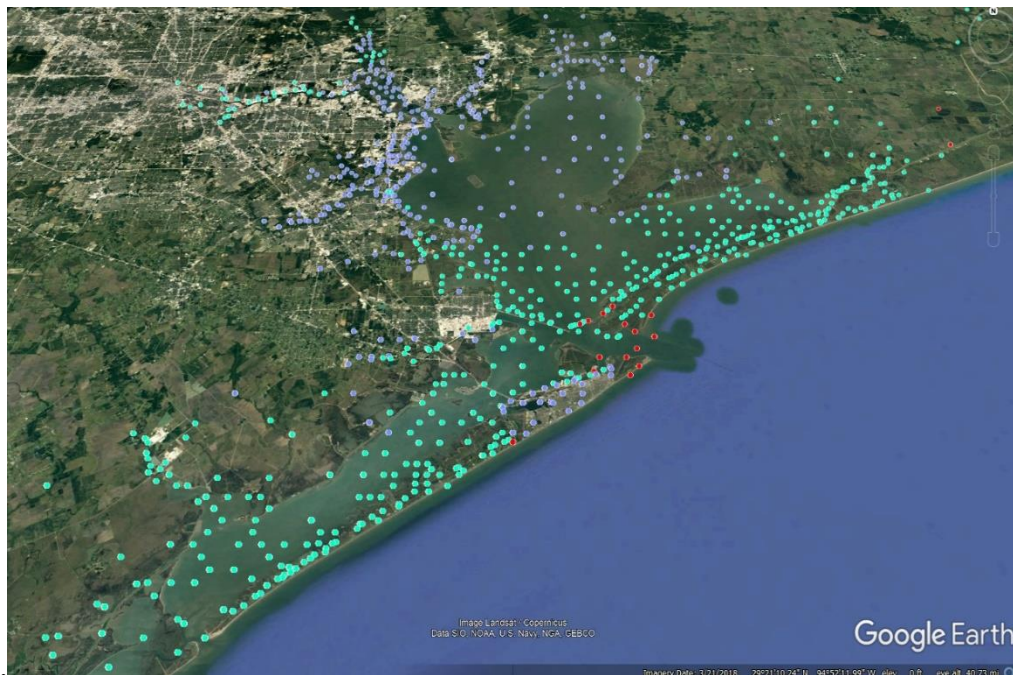

Figure 2-27: WP and WOP SWL Difference Map (1% AEP, Year 2035, Intermediate RSLC)

2.6.4 With Project Still Water Level: Discussion on Inducements

Figure 2-28 shows the 0.5% AEP SWL (50-year Return Period) difference map which is created by subtracting with-project results from the without-project condition. Here, negative values represent

water level reduction, while positive values represent inducements. From this figure, overall reduction of water level across the Galveston Bay area are observed. Also, in this figure, inducements (increase in water level) especially behind the surge barrier system are evident (positive difference, yellow to red color). Parts of these inducements are an artifact of the gate modeling limitations encountered in the current study which needs to be addressed in future. Current probabilistic modeling does not account for gate operation criteria. Thus, 170 WP synthetic tropical cyclone hydrodynamic simulations are done considering surge barrier in closed condition irrespective of any gate operation criteria (e.g., track orientation, SWL trigger). Gate closed condition was applied for the entire duration of all synthetic storms. This becomes an issue as gate closure on unfavorable tracks sometimes traps water inside the Bay prohibiting water to escape through the Bolivar inlet. As a result, water level piles up behind the surge barrier which eventually propagates through the East and West Bay creating adverse impacts. This condition is illustrated in Figure 2-29. In this case, storm 270 which is a Category 4 storm on an East-West track making landfall East of Bolivar. First panel shows existing condition situation illustrating little impacts in Galveston Bay region. Middle panel shows with project situation where storm surge barrier has been closed for the entire duration of the storm. As a result, massive surge (>20 ft) builds up behind the barrier system. Third panel shows the simulated condition where surge barrier remains open during the storm due to non-satisfying trigger condition. In this case, no adverse conditions (inducements) are observed as still water level remains similar to the without project condition. This demonstrates the importance of incorporating gate operation trigger in modeling which needs to be explored in future. Due to this anomaly, in CTX simulations, inducements, especially at low return periods and on adverse storms tracks (e.g., East-West track) are observed which we believe are an artifact of modeling limitations in the current study. In the economic analyses, these inducement anomalies underscore the benefit that has been calculated.

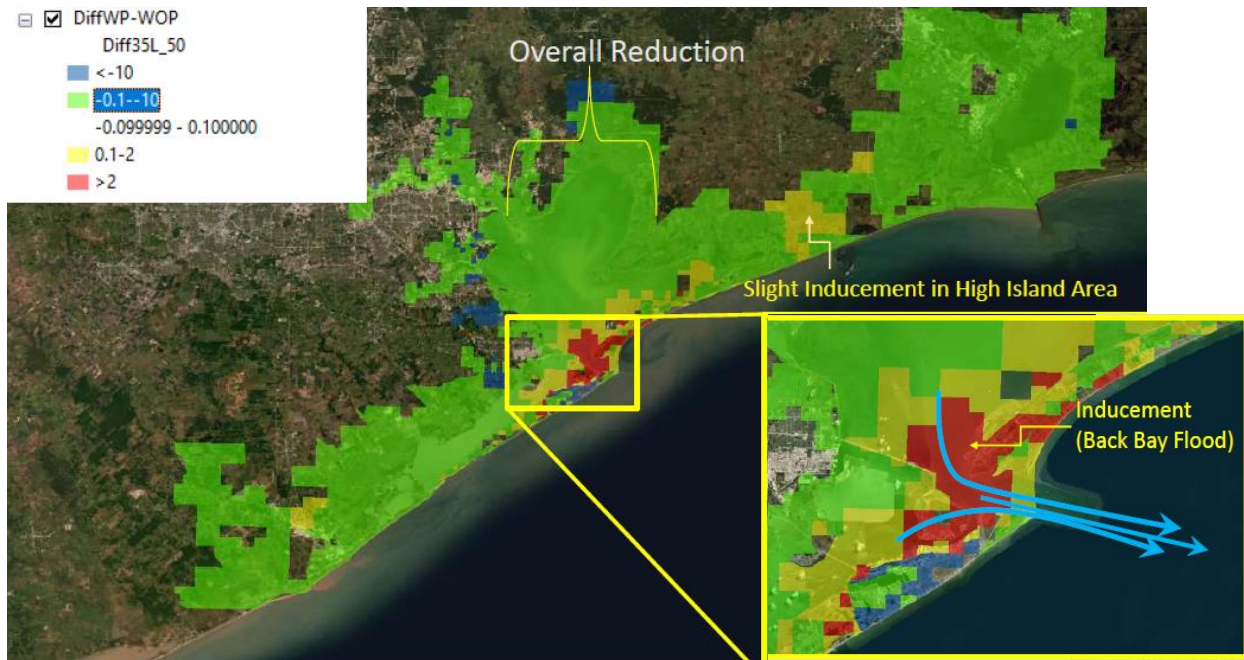

Figure 2-28: WP and WOP SWL Difference Map (0.5% AEP, Year 2035, Intermediate RSLC)

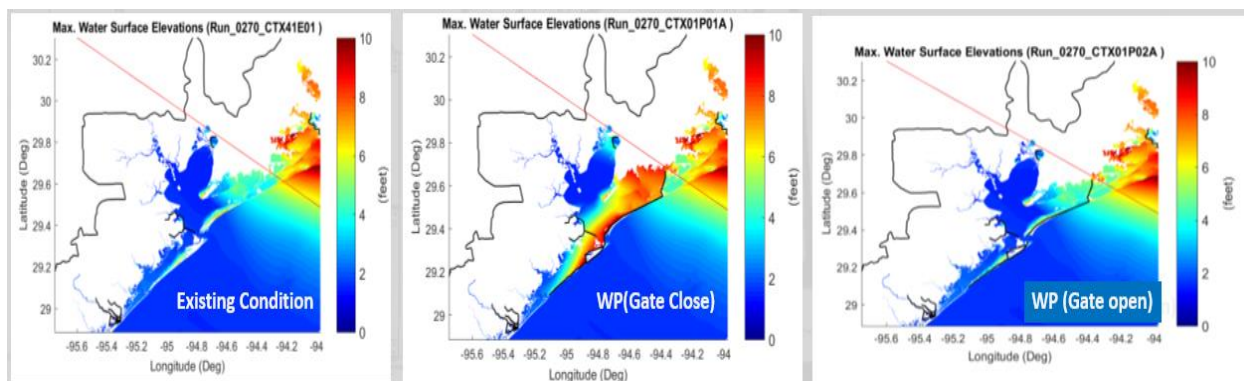

Figure 2-29: Impact of Gate Closure on Storm Track (Storm #270)

2.7 DESIGN GUIDANCE

The criteria used for conceptual design of the systems and crest elevations is based on damage overtopping limit state with annual exceedance probability of 1%. This elevation has a one-percent chance of being equaled or exceeded during any year. One of the assumptions in the design approach is that the maximum water elevation and the maximum wave height occur simultaneously. Although this assumption might be conservative for some locations, we feel that assuming a coincidence of maximum surge and maximum waves is reasonable for most of the levee and floodwall sections in our design approach. This is consistent with present USACE practice and other recent regional projects such as S2G. The Hurricane and Storm Damage Risk Reduction System (HSDRRS) design guidelines (USACE

2012) criteria were applied to estimate levee and floodwall crest elevation. The following criteria for crest elevation have been applied:

For the 1% annual exceedance probability (1% AEP) still water, wave height and wave period, the maximum allowable average wave overtopping of 0.1 cfs/ft at 90% level of assurance and 0.03 cfs/ft at 50% level of assurance for floodwalls. The HSDRRS criteria also include 1.0 cfs/ft as an ultimate limit for both floodwalls and earthen levees.

10 and 25-year rainfall events in conjunction with overtopping rates associated with the 1% AEP storm are used for drainage analyses and sizing of pumps. The analysis assumes that the peak rainfall and overtopping events occur simultaneously which is a very conservative approach. It is recommended that probabilistic dependence of rainfall and surge events be analyzed in future in order to optimize pump sizes.

2.7.1 **Crest Elevation for the Galveston Ring Barrier System (GRBS)**

Wave overtopping calculations were conducted by Mott Macdonald (Annex 3) following the EurOtop Manual (Pullen, et al 2007). Both deterministic and probabilistic overtopping equations were used. Sensitivity analysis showed that various methods for calculating overtopping are not consistently conservative, meaning that selecting one method over another does not necessarily guarantee lower or higher values. For consistency, the EurOtop deterministic equations were applied to estimate overtopping rates for the GRBS system. Details can be found in Annex 3. Overtopping analysis along the proposed GRBS used 1% AEP SWL and wave statistics that are explained before. Figure 2-30 shows different configurations of the GRBS system with color coded arrows represent linear shoaling to transform waves to structure. Table 2-10 summarizes 1% AEP With Project (WP) SWL and Wave condition at 50% and 90% Confidence Interval (CI) for the SLC0 case.



Figure 2-30: GRBS system with arrows representing linear shoaling to transform waves to structure.

Table 2-10: 1% AEP at 50% and 90% Confidence Interval (CI) SWL & Wave Condition

Point	WSE [ft NAVD88] - 50% CI	WSE [ft NAVD88] - 90% CI	Hs [ft] - 50% CI	Hs [ft] - 90% CI
11892	10.0	12.3	2.1	2.5
12773	9.2	11.3	5.3	6.2
12841	8.6	10.6	2.0	2.4
12962	9.6	11.7	5.8	6.8
17276	8.3	10.3	3.3	3.9
17284	9.6	11.8	4.0	4.6

A timeseries showing water surface elevation, wave heights, and peak overtopping rate at point 17824 (Offatts Bayou) is shown in Figure 2-31. In this calculation, floodwall heights are set at +14 ft NAVD88. A summary of the peak overtopping rates at the extraction points along the GRBS system are shown in Table 2-11.

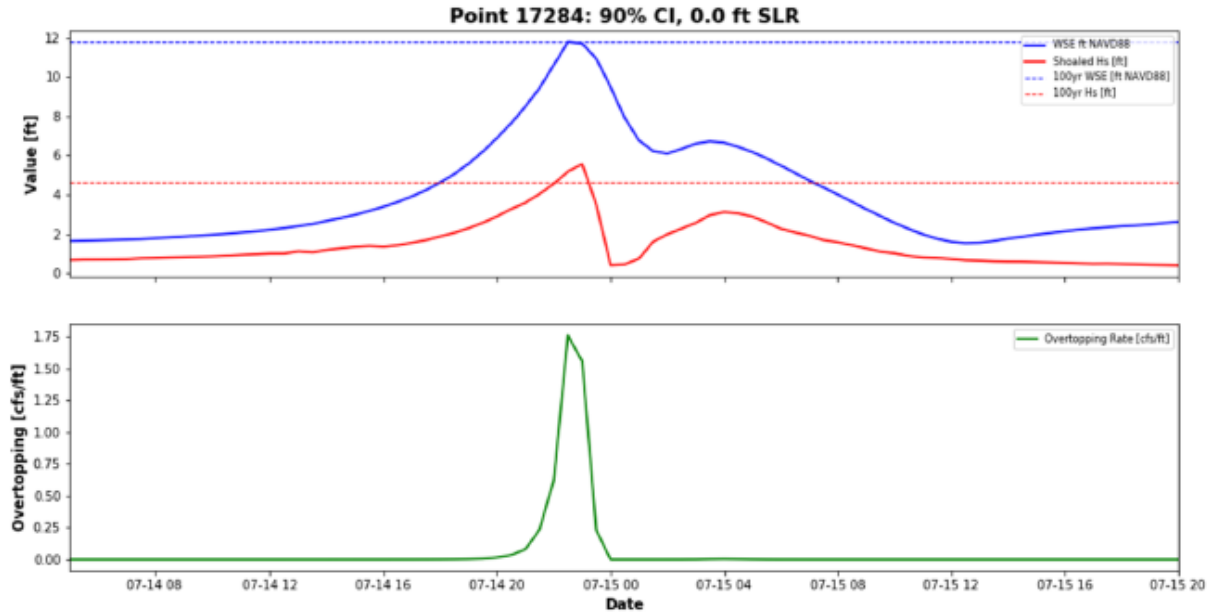

Figure 2-31: Timeseries of water surface elevation and wave heights (top), overtopping rates (bottom)

The overtopping rates shown in Table 2-11 are color coded to represent exceedance of different thresholds per HSDRRS criteria which is 1.0 cfs/ft for the ‘ultimate limit’, and 0.1 cfs/ft at the 90% CI for the ‘no damage’ state. Red values indicate that the peak overtopping limit exceeds the ‘ultimate limit’ threshold, and orange values indicate that ‘no damage’ limit is exceeded. Based on the results shown in Table 2-11, large portions of the proposed floodwall along the GRBS are expected to exceed the limit state. Therefore, armoring, reinforcement, and/or specialized floodwall to manage overtopping is recommended to prevent excessive damage behind the floodwall. Several pumps along the GRBS are proposed to drain out overtopping volume during extreme events.

Table 2-11: Summary of Peak Overtopping Rates [cfs/ft] along extraction points (Figure 2-30)

Point	100-year, 90% CI, 0.0' SLR [cfs/ft]
11892	0.61
17284	1.76
12962	1.06
12773	0.19
12841	0.01
17276	0.39

As noted earlier, HSDRRS (USACE, 2012) suggests a maximum overtopping rate of 0.1 cfs/ft (9.3 L/s/m). However, HSDRRS states that this is a site-specific overtopping rate and safe overtopping rates varies depending on adjacent structures. For example, large overtopping volumes are acceptable along the sector gate and combi-wall section across Offatts Bayou. Along the harbor drive and port area, the majority of the sections are paved where limit state overtopping is higher than 1 cfs/ft.

Note that sea level rise will cause increase in peak overtopping rates. To mitigate this, floodwall elevations along the GRBS may needs to be raised in future to adapt with the RSLC. Figure 2-32 shows sensitivity analyses with raised floodwall heights using SWL and wave climates with 2.1 ft RSLC condition. This condition represents storm climate for year 2085 with intermediate RSLC condition. With this scenario, as shown in Figure 2-32, in order to reduce peak overtopping rate below the ultimate limit state, the floodwall would have to be raised to +18.0' NAVD88. Note that the with RSLC scenario included a linear addition of SLR to the extremal WSE. In addition, the wave shoaling accounted for the increase in WSE due to RSLC. It is important to highlight that proposed offshore breakwaters, once implemented will greatly reduce wave energy exposed to the proposed structure. While this is understood that offshore breakwaters will reduce wave overtopping potential, quantitative assessments are not done in this phase of the study. Therefore, it is recommended that in future phases, detailed near shore wave and probabilistic modeling are performed by incorporating nearshore elements such as, breakwaters and structural configuration along with surge barrier operation in order to optimize crest heights along the GRBS. Another point to highlight that higher floodwall height (+17 ft NAVD) along the GRBS was initially modeled and proposed. But higher above ground “stick up heights” were great concern to stakeholders due to obstruction of views. As such, the team had to find an optimum solution balancing performance and acceptability. However, PDT will conduct a detailed risk assessment in accordance with ER 101 in future in order to optimize crest heights and shapes (e.g., recurve wall) along the GRBS system by evaluating residual flood risk and management strategy (e.g., pump operation). For feasibility level design, crest height for the floodwall along the GRBS and the Offatts Bayou closure system are set at +14 ft NAVD 88 which is subject to optimization during PED. GRBS has always been a challenging component primarily because of its footprint with mixed stakeholder opinion. As such,

appropriate contingencies in cost and quantity are applied to accommodate uncertainties and design optimization in future.

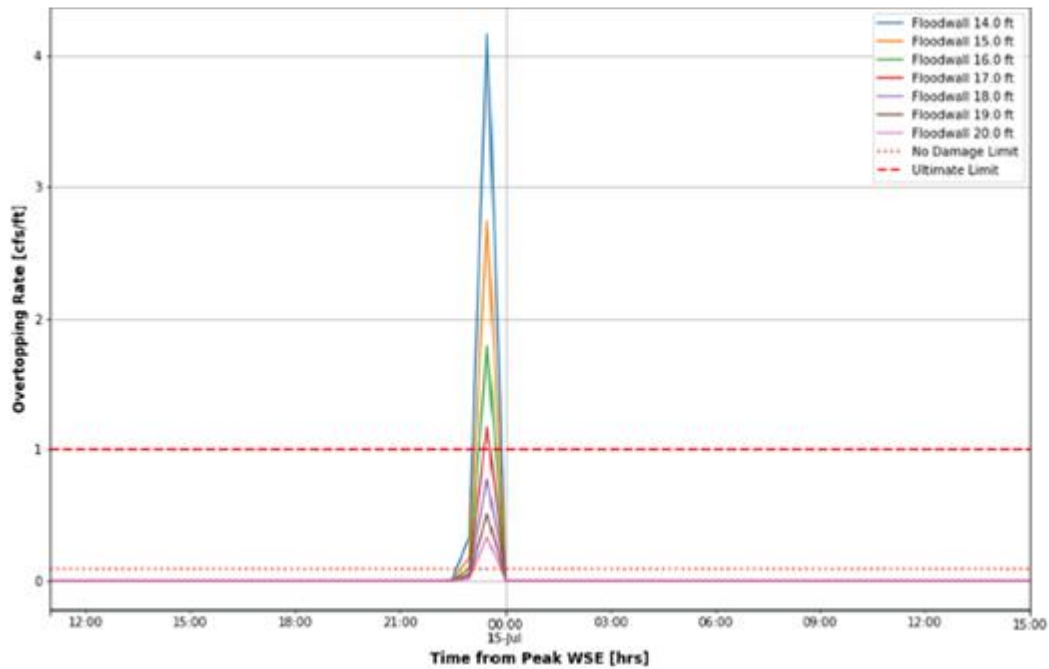

Figure 2-32: GRBS System Height Sensitivity on RSLC Scenario

2.7.2 Crest Elevation for the Clear Lake & Dickinson Bay Closure System

Even though the storm surge barrier at Bolivar road significantly reduces the storm surge entering the bay, the bay has large enough fetch that can generate local wind generated surge with increased water surface elevations which can cause damages to low-lying structures along Clear Lake and Dickinson Bay. As such, closure structures consisting flood walls, pump station, and sector gates are proposed across Clear Lake and Dickinson Bay. Similar to the Galveston Ring Barrier System (GRBS), crest elevations along the Clear Lake and Dickinson Bay closure structures are set following the HSDRRS guidelines. The SWL values for Dickinson Bay are shown in Table 2-12 for both with-project condition (WP) and future-without-project conditions (FWOP). The SWL values for Clear Lake are shown in Table 2-13 for both WP and FWOP conditions. Both extraction points were taken on the Galveston Bay side of the proposed structure Alignment. Note that these calculations were done using the initial with project modeling on alignment (Alt-A) by Mott Macdonald. Due to close similarity in Alt-A and current Recommended Plan alignment, as well as similarity in with project WSE and wave climates, overtopping volumes are expected to be similar and are not repeated.

Table 2-12: 1% AEP with 90% CI SWL [ft NAVD88] for Dickinson Bay.

SLR	Scenario	100-yr Return Period	200-yr Return Period	500-yr Return Period
2017	FWOP	14.1	16.5	19.0
2035	FWOP	14.7	17.1	19.6
2085	FWOP	16.7	19.1	21.6
2017	Alt A	10.0	11.9	14.6
2035	Alt A	10.7	12.6	15.3
2085	Alt A	12.8	14.7	17.4

Table 2-13: 1% AEP with 90% CI SWL [ft NAVD88] for Clear Lake.

SLR	Scenario	100-yr Return Period	200-yr Return Period	500-yr Return Period
2017	FWOP	14.8	17.4	20.0
2035	FWOP	15.5	18.0	20.6
2085	FWOP	17.4	20.0	22.6
2017	Alt A	10.7	12.2	14.1
2035	Alt A	11.4	12.9	14.8
2085	Alt A	13.5	15.1	16.9

The proposed wall and sill elevations are shown in Table 2-14. Using the datum conversions both the NAVD88 and MLLW elevations for each location were calculated and are presented in Table 2-14.

Table 2-14: Elevation of Top of Wall and Sills.

	Sill Elevations		Top of Wall Elevations	
	[ft MLLW]	[ft NAVD88]	[ft MLLW]	[ft NAVD88]
Dickinson	-9	-9.24	18.24	18
Clear Creek	-12	-12.24	17.24	17

To refine the top of wall elevations, overtopping analyses at Clear Lake and Dickinson Bay were conducted. Details can be found in Annex 2, 4, and 5. HSDRRS (USACE, 2012) suggests a maximum overtopping rate of 0.1 cfs/ft (9.3 L/s/m). However, HSDRRS states that this is a site-specific overtopping rate. Since the HSDRRS guidelines are site specific, overtopping guidance from the Coastal Engineering Manual (USACE, 2012) was investigated. Varying top elevations of the floodwall were tested at each site. A peak overtopping rate of 0.39 cfs/ft (36 l/s/m) was calculated at Clear Lake with a +17 ft NAVD88 wall, and 0.48 cfs (45 l/s/m) at Dickinson Bay with a +18 ft NAVD88 wall. Both flowrates fall under the “Damage if back slope not protected” category for embankments and seawalls. Since there is no infrastructure on the immediate backside of the Clear Lake and Dickinson structures, these overtopping rates were deemed appropriate so long as protection is added to the backside of the

structures. The peak overtopping rates were included in the pump station design at these structures and discussed in Section 2.7.4. Another interesting point to highlight is the variations in top-of-wall elevations among GRBS and Clear Lake and Dickinson system where GRBS has much lower elevations. This is due to higher with project SWL along West side of Galveston Bay in comparison with the SWL at West Bay behind the GRBS system. Figure 2-33 shows an example simulation where behind the GRBS, water surface elevation is about 50% of what has been estimated at Clear Lake region.

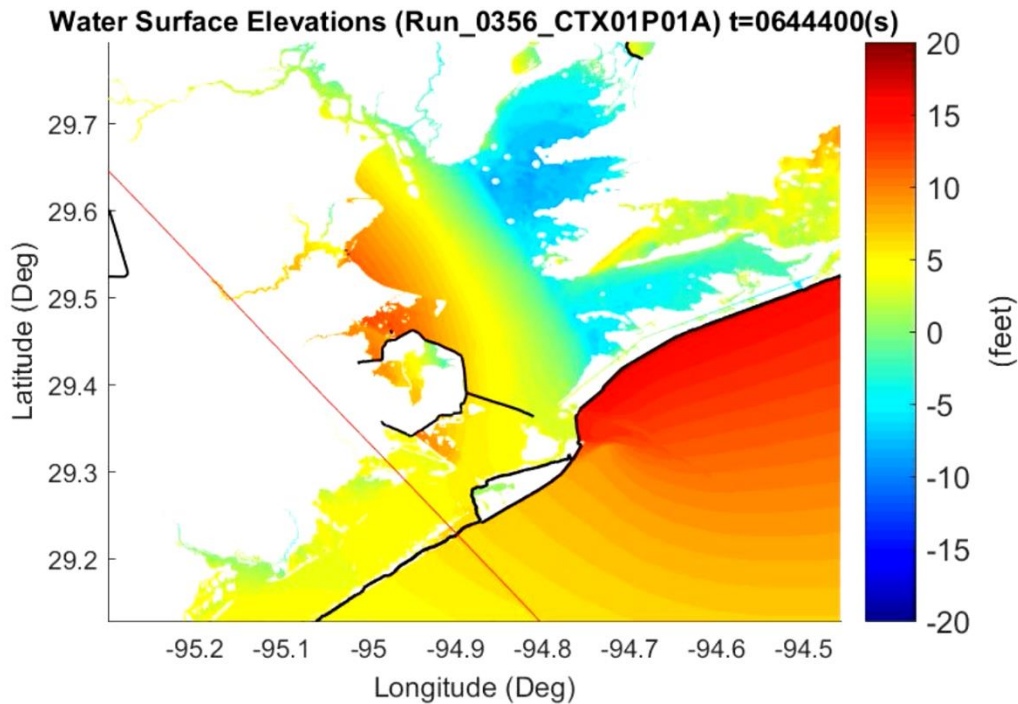

Figure 2-33: Variations in With-Project SWL

2.7.3 Crest Elevation for the Bolivar Road Surge Barrier System and Sea Wall Modification

Although similar HSDRRS design guidelines are followed for the sea wall vertical extension, there are no guidelines for limit state overtopping for the surge barrier system. However, in determining the surge barrier height, it must be realized that height determines the leakage (overtopping) through the barrier. If no leakage is accepted the height should be well above design water level. However, given the large buffer capacity of Galveston Bay, leakage and overtopping should be well accepted. The height should then be such that the discharge over the crest could be handled without increasing the water level behind the barrier. To determine the crest height for the surge barrier system, first static head difference between front and back side of the gate from historic and future possible synthetic storms are looked. Figure 2-34 shows that from the sample of 170 simulated storms, without considering RSLC, maximum water surface elevation is close to 5.8 m (19 ft) which is equivalent to 0.1% AEP (1000 year) SWL at 90%

CI. Note that 0.2% AEP (500 year) SWL at 90% CI at Bolivar road is 16.5 ft NAVD 88. A peak overtopping rate of 3.5 cfs/ft was calculated at Bolivar road with a +21 ft NAVD88 vertical wall.

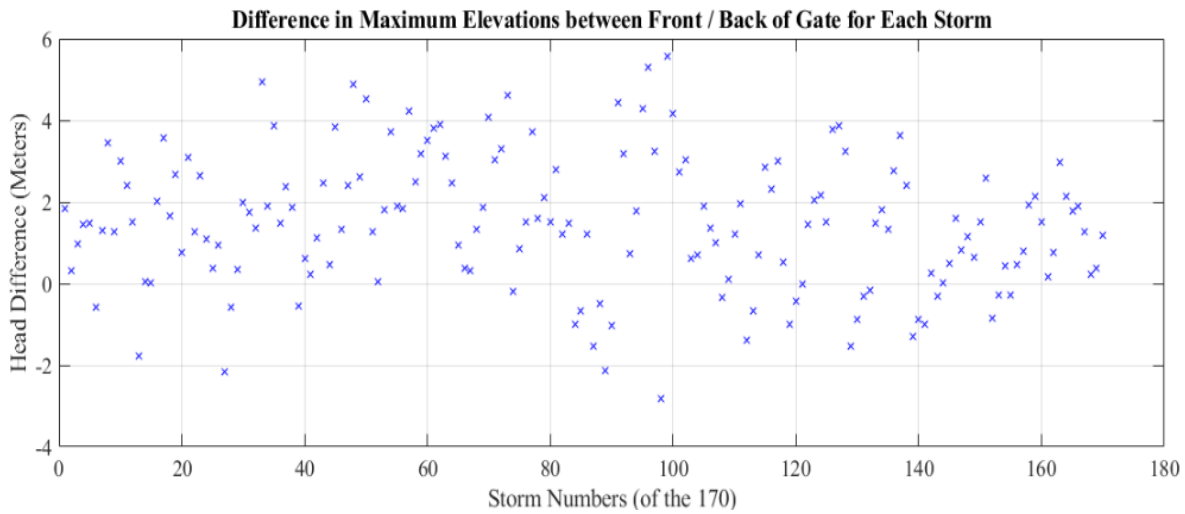

Figure 2-34: Difference in Elevations Between Front and Back Side of Surge Barrier

An overtopping analysis was conducted along the Galveston Sea Wall. This analysis was conducted to determine whether overtopping of the proposed seawall improvements and ring levee causes any additional flooding on the Island. Overtopping of coastal structures is highly dependent on both the cross-sectional design of the protection element and the ocean conditions during a storm event. As detailed design of the sea wall extensions are not available, idealized cross sections (Figure 2-35) were used to calculate overtopping rates.

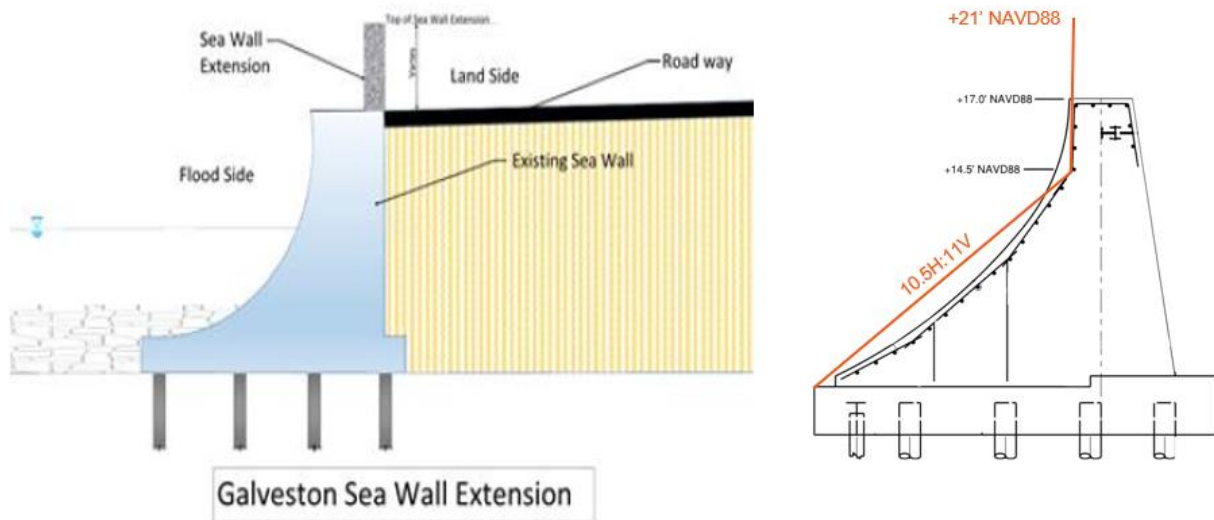

Figure 2-35: Schematics of Seawall Extension

Equations from the Eurotop, 2016 manual were used to calculate overtopping timeseries along the proposed seawall. A neural network tool developed by Eurotop 2016 was also tested. (Eurotop, 2016, Formentin et al., 2017, Zanuttigh et al. 2016). Along the proposed seawall improvement, the neural network tool showed similar overtopping rates when compared to the analytical equations (Equation 5.18 of Eurotop, 2016). The neural network tool showed slightly more conservative (i.e. higher) overtopping rates and was therefore used to compute overtopping volume along the proposed seawall expansion. The peak overtopping rate experienced with the 1% AEP event with +21ft NAVD 88 is 3.4 cfs/ft which exceeds the limit state. Combinations of raising the seawall and adding a return wall to reduce overtopping are investigated. Sensitivity testing reveals that 1-ft-high by 3-foot-wide return wall yielded the greatest reduction in overtopping volume. This suggests the sensitivity of seawall extension shapes which should be an area of future work during design optimization. Results are shown below in Table 2-15. For feasibility level design, crest height for the sea wall extension and Bolivar road surge barrier system are set at + 21 and +21.5 ft NAVD 88 which is subject to optimization during PED.

Table 2-15: Overtopping flowrates and volumes for varying top elevations of seawall improvement. Testing conducted with and without 1 ft high by 3 ft wide return wall

Scenario	T.O. Seawall Elevation [ft NAVD88]	Peak Overtopping Flowrate [cfs/s/ft]	Peak Overtopping Volume* [cfs/s]
No Return Wall	21	3.49	147,919
	22	2.50	105,917
	23	1.74	73,960
	24	1.18	50,219
	25	0.78	33,236
With Return Wall	21	1.85	78,591
	22	1.88	79,768
	23	0.35	14,705
	24	0.23	9,911
	25	0.15	6,207

*Volume assumes a total seawall length of ~42,000 lf.

2.7.4 Pump Sizing: Galveston Ring Barrier System (GRBS)

The hydrologic and hydraulic modeling for the City of Galveston was conducted using the Environmental Protection Agency Storm Water Management Model (EPA SWMM). The analysis included the evaluation of five storm return periods: 10, 25, 50, 100, and 500-year precipitation events. The precipitation depths and distributions were taken from National Oceanographic and Atmospheric Administration (NOAA) Atlas 14 Volume 9 data. Details can be found in Annex 2 and Annex 5(Mott Macdonald, August 2018, February 2020).

Within the GRBS, use was made of existing storage capacity within Offatts Bayou by dewatering the interior area in advance of the storm (to -1 ft MLLW) and by allowing the interior water surface to rise

to a predetermined maximum elevation (+4' NAVD88) to attenuate peak flow without causing damages. External wave and water surface elevations were used to develop overtopping calculations for the 100-year 90% Confidence Interval (CI) event. The hydrology and hydraulic models were used to develop the design facilities for the 25-year rainfall event in combination with the overtopping rate associated with the 100-year tropical storm. Figure 2-36 shows the schematic of GRBS drainage and pump station and Table 2-16 summarizes their estimated capacities. Combined pumping capacity along the GRBS was estimated to be 16,000 cfs.



Figure 2-36: Schematic of GRBS Drainage and Pump Station Developed by Mott MacDonald

Table 2-16: Design Pump Capacity along the GRBS System

Pump Site	Pump Size	Conduit Channel Cross Section Size	Max Water Surface Elevation in Offatts Bayou
Offatts Bayou (Pump Site 1)	4500 cfs	32' wide x 13' high 416 sf	3.25 ft NAVD88
Pump Site 2	1500 cfs	20' wide X 10' high 200 sf	-
Pump Site 3	5000 cfs	30' wide X 10' high 300 sf	-
Pump Site 4	5000 cfs	25' wide X 10' high 250 sf	-

Numerous tradeoffs between project cost, project impacts and overall effectiveness of the GRBS were evaluated and made during the refinement of the alignment. Accordingly, the location of the pump stations originally designed by Mott MacDonald were further refined with the followings: 4500 cfs pump station at Offatts Bayou, 5000 cfs pump station at 48th Street, 1500 cfs pump station at Pier 19, 5000 cfs pump station at UTMP, 5000 cfs pump station at 48th Street, 500 cfs pump station at Fort Point Road. Another small pump (50 cfs capacity) has been proposed at the Gas Pipeline facility to aid interior drainage. Details are shown in Annex 5. Note that the analyses do not include overtopping from sea wall which is considered to be negligible or manageable due to planned modification of the current sea wall. Also, while the majority of drainage systems in the GRBS are gravity driven, the City of Galveston is continuing to make improvements to the system, including forced, or pumped, drainage systems. During PED, the USACE will continue to work with the City to ensure that there are not conflicts between the City’s current or existing plans and the Recommended Plan.

2.7.5 Pump Station at Clear Lake Crossing

The Clear Lake and Armand Bayou watersheds (collectively referred to as Clear Lake) cover approximately 260 square miles located in southern Harris County and some sections of Galveston, Brazoria and Fort Bend counties. The Clear Lake watershed drains to the east and outfalls into Galveston Bay, while the Armand Bayou drains to the south and connects to the Clear Lake watershed at Clear Lake. The Clear Lake watershed has an average development percentage of about 30%, with most of the development on the downstream portion, while the Armand Bayou watershed has a slightly higher development percentage of 45% with an even distribution of development. Undeveloped areas in both watersheds are mostly covered by pastures that tend to pond during extreme rainfall events.

The initial project flood protection facilities for the Clear Lake watershed developed by Mott MacDonald (2018) (Annex 2, Annex 5) consist of a 17-foot high (NAVD88) seawall spanning Clear Lake approximately 300-feet west of the HWY 146 bridge which ties into a 17-foot flood protection on

the north and, south sides of the lake as shown in Figure 2-37. The seawall has a large sector gate with a sill elevation of -12 feet (NAVD88) across the main channel and retains the existing series of six 20' x 20' lift gates with sill elevations of - 15 feet (NAVD88) across the northern secondary channel.



Figure 2-37: Clear Lake Crossing

The general development of the pumps is based on the following design criteria:

- (a) 100-year surge event for this analysis was taken as coincident with a 25-year rainfall event; during this event the navigation gates are closed and the maximum water level upstream of the gate shall not exceed MHW.
- (b) The 100-year rainfall event is not coincident with storm surge; during this event the navigation gates are open, the pumps are operational, and the maximum water level shall not exceed the maximum water level from existing conditions, when the 100-year hydrograph is run against a tail water of MHW.
- (c) Overtopping rate at 1% AEP

Based on the above design criteria, the proposed 75-foot-wide sector gate with sill elevation of -12 ft (NAVD88) supported by a pump station with a capacity of 45,651 cfs meet the design criteria for Clear Lake. Figure 2-38 shows the footprint of the closure system that was originally designed by Mott MacDonald. The proposed pump capacity is more than twice the capacity of the West Closure Complex in New Orleans, but brings some significant benefits. With these proposed facilities, drainage will be improved for a 10 and 25-year rainfall (+30%), even when coupled with a 100-year storm surge. For a 50, 100 and 500-year rainfall (+30%), the proposed facilities may also improve drainage if not coupled with storm surge. The proposed facilities designed by Mott MacDonald show negligible impact to tidal circulation.



Figure 2-38: Clear Lake Gate Closure System with Pump Station Footprint (Annex 5)

As evident from Figure 2-38, proposed pump station and associated footprint across Clear Lake would create significant impact to adjacent properties. As such, and based on stakeholders’ inputs, revisions to the Clear Lake closure structures are made. Revisions include -modifications of H&H design criteria and location of the pumping station to minimize impacts. Additional model runs allowing the interior water surface elevations (WSE) to rise up to the existing conditions level and using modified design criteria of 100-year surge event as coincident with a 10-year rainfall event, revised pump capacity was 21,100 cfs. For cost estimate, Clear Lake pump station with a design capacity of 20,000 cubic feet per second (cfs) has been used which is subjected to further refinement during PED.

2.7.6 Pump Station at Dickinson Bay Crossing

The Dickinson Bay watershed is a coastal basin located in Galveston and Brazoria Counties with a drainage area of 98 square miles. Dickinson Bay watershed drains from west to east discharging in Galveston Bay at State Highway 146. Its land use is characterized by a combination of developed areas, farmlands, and undeveloped areas. The elevation in Dickinson Bay ranges from 15 to 0 ft NAVD88.

The initial project flood protection facilities for the Dickinson watershed developed by Mott MacDonald (2018) consist of an 18-foot high (NAVD88) seawall spanning the mouth of Dickinson Bay from its east to west bank, as shown in Figure 2-39. The proposed closure has an initial 60 ft wide sector gate with a sill elevation of -9 feet (NAVD88) which was later optimized to 100 ft opening to improve circulation. Based on the criteria outlined above, the proposed 100-ft wide sector gate with sill elevation of -9 ft.



Figure 2-39: Dickinson Bay Crossing

(NAVD88) supported by a pump station with a capacity of 19,125 cfs meet the design criteria for Dickinson Bay. The proposed pump capacity mimics the West Closure Complex in New Orleans, LA, which consists of 11 pumps at 1,740 cfs each for a total capacity of 19,140 cfs (USACE, 2014). Figure 2-40 shows the Dickinson Bay closure structures with pump station footprints.

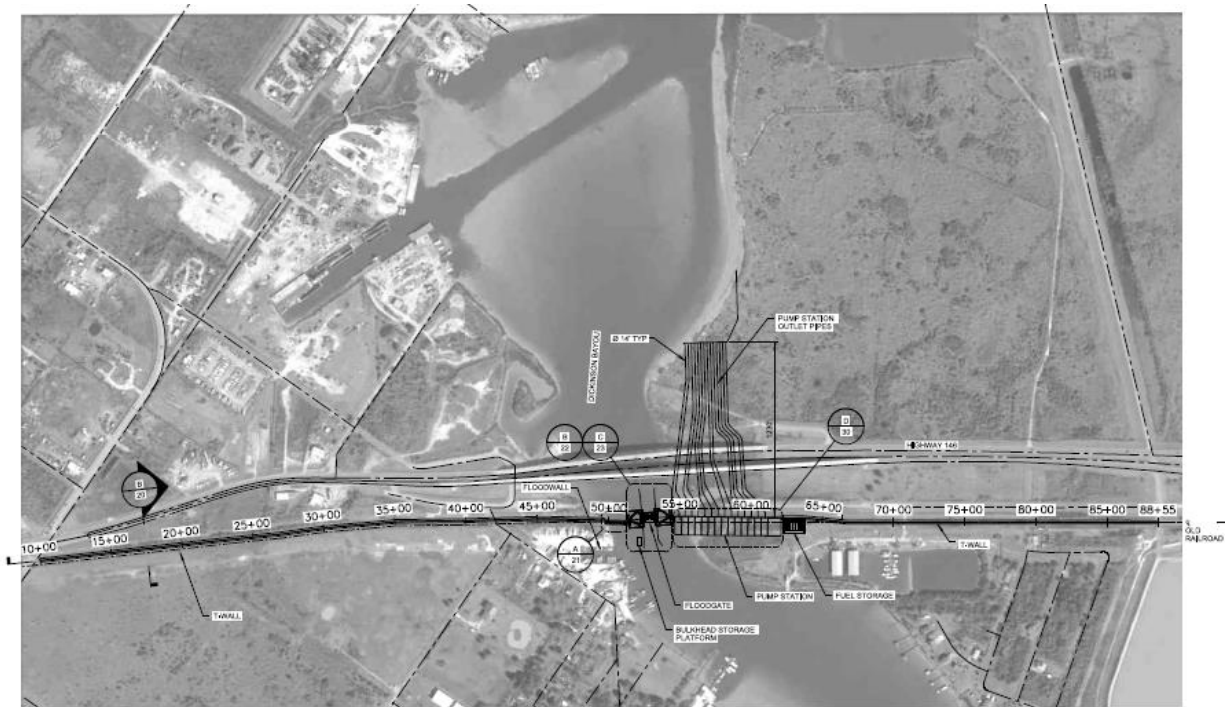

Figure 2-40: Dickinson Bay Gate Closure System with Pump Station Footprint (Annex 2, Annex 5)

Similar to Clear Lake pump station, additional model runs allowing the interior water surface elevations (WSE) to rise up to the existing conditions level and using modified design criteria of 100-year surge event as coincident with a 10-year rainfall event, revised pump capacity was estimated to 13,750 cfs. Although for cost estimate, Dickinson Bay pump station with a design capacity of 19,500 cubic feet per second (cfs) has been used, it is expected to be significantly reduced with H&H refinement during PED.

2.8 SALINITY, VELOCITY AND ENVIRONMENTAL MODELING

ERDC developed a 3D Adaptive Hydraulics (AdH) model for the Galveston Bay as part of the Coastal Texas Study (McAlpin et al. 2019b). This model was modified to represent the revised storm surge barrier structure for the “With-Project” simulation denoted as the 2019PWP condition. Although the base condition (present without-project condition) was simulated previously (McAlpin et al. 2019b), it was re-run for the revised analyses. The base condition and the alternative are run for 2 years. The first year is a spin-up period to obtain an accurate initial salinity field and the second year is used for all analyses. The model development and boundary condition definitions for the hydrodynamic, salinity, and sediment transport model as well as model calibration/validation to water surface elevation, velocity, and salinity are documented in McAlpin et al. 2019a. A five-week period (months of February and March) was extracted from the second year of the AdH simulation. The extracted hydrodynamic results at 30-minute intervals provide input to the Particle Track (PTM) model. This model tracks particles that are given characteristic transport behaviors to mimic transport of larval species

representative to the area. Recruitment analysis resulting from the PTM simulations is used to determine the environmental impact due to the proposed structures. Details can be found in the annex to this Appendix (Tahirih & McAlpin, 2020). It is important to note that Rollover Pass has been kept open in all simulations. Recently the Pass has been closed by GLO. However, at the time of ADH model validation (2019), it was still open. Accordingly, all modeling exercises for the CTX were conducted as if Rollover Pass is still open. As Rollover Pass contributes insignificant tidal exchange (~3 percent), impacts on modeling by keeping Rollover Pass open or closed are expected to be insignificant. Section 2.8.4 has further details. Figure 2-41 shows ADH model grid representing revised storm surge barrier alignment.

The Recommended Plan (RP) analyzed with the current AdH model includes beach and dune system along Bolivar Peninsula and Galveston Island, improvements to the Galveston seawall, a ring barrier around the city of Galveston, and revised gate closure structures across Bolivar Roads, Offatts Bayou, Dickinson Bay, and Clear Lake. The RP, defined as 2019PWP, has been used for the PTM and AdH analyses to evaluate impacts on salinity and velocity.

In the RP, the surge barrier system at Bolivar Roads includes two, 650 ft wide, -60 ft sill elevation sector gates across the ship channel. Two additional 125 ft wide, -40 ft sector gates along with 15, 300 ft wide vertical lift gates (7 having a -40 ft sill elevation and 8 having a -20 ft sill elevation) lie to the east and west of the ship channel. The northernmost section of the barrier consists of 16 shallow water environmental gates, each with 6 openings 16 ft wide with a -5 ft sill elevation. All elevations are referenced to Mean Lower Low Water (MLLW). Figure 2-41 shows the surge barrier system defined as the 2019PWP alternative.



Figure 2-41: Revised Storm Surge Barrier Modeled (2019PWP) for the AdH model domain.

2.8.1 **Input Conditions**

For this analysis, the 2010 validation year was considered as a base or starting point for the year zero (present–2035) and year 50 (future–2085) model inputs. For details of the 2010 model boundary conditions, see McAlpin et al. (2018). The tidal water surface elevation, and freshwater inputs are the only model inputs that would vary from the 2010 base condition. Data availability for each input parameter determines if consecutive years of data are used for the 2-year simulations or if a single year of data are repeated. RSLC values described in Section 2.4.3 are used for adjustments to initial water level. Input conditions include freshwater river inflows, tide elevation, ocean salinity, and wind. All model input conditions match those for the present condition are referenced in McAlpin et al. 2019b. No sediment was included in these simulations.

2.8.2 **Freshwater Inflow**

Freshwater inflow into the model domain was applied at the two major rivers — Trinity River and San Jacinto River and at seven ungauged flow locations. These flow values were obtained from the Texas Water Development Board’s (TWDB) hydrology model which computes flows for the area from the 1970s to present (Schoenbaechler and Guthrie, 2012). The years 1985 and 1986 were taken as typical flow conditions for the region and would be a good estimate of future flow patterns. Through verbal consultation with TWDB, the freshwater flow into the Galveston Bay system has been reduced by approximately 12 percent over the 50-year project life. This reduction is primarily due to projections of increased water needs by the surrounding municipalities, meaning that more volume will be diverted

to local water supply and less enters the bay system. Future to present condition are analyzed and adopted a ratio of 0.7 to 0.9 from a previous study (Matsumoto, 2012). The ratio considers long term urban growth and associated reduced flow while precipitation is held constant.

For year 2035 (present) conditions, 2009 (spin up year) and 2010 (analysis year) inflows are used for all freshwater inflow locations as the model validations are made on those conditions. Figure 2-42 shows the year 2035 inflows. For year 2085 (future) conditions, 88 percent of the 1985 (spin up year) and 1986 (analysis year) freshwater inflows are used for the Trinity River and San Jacinto River. and 88 percent of the 2009 and 2010 inflows are used at the ungauged locations. Figure 2-43 shows the 2085 inflows for future conditions.

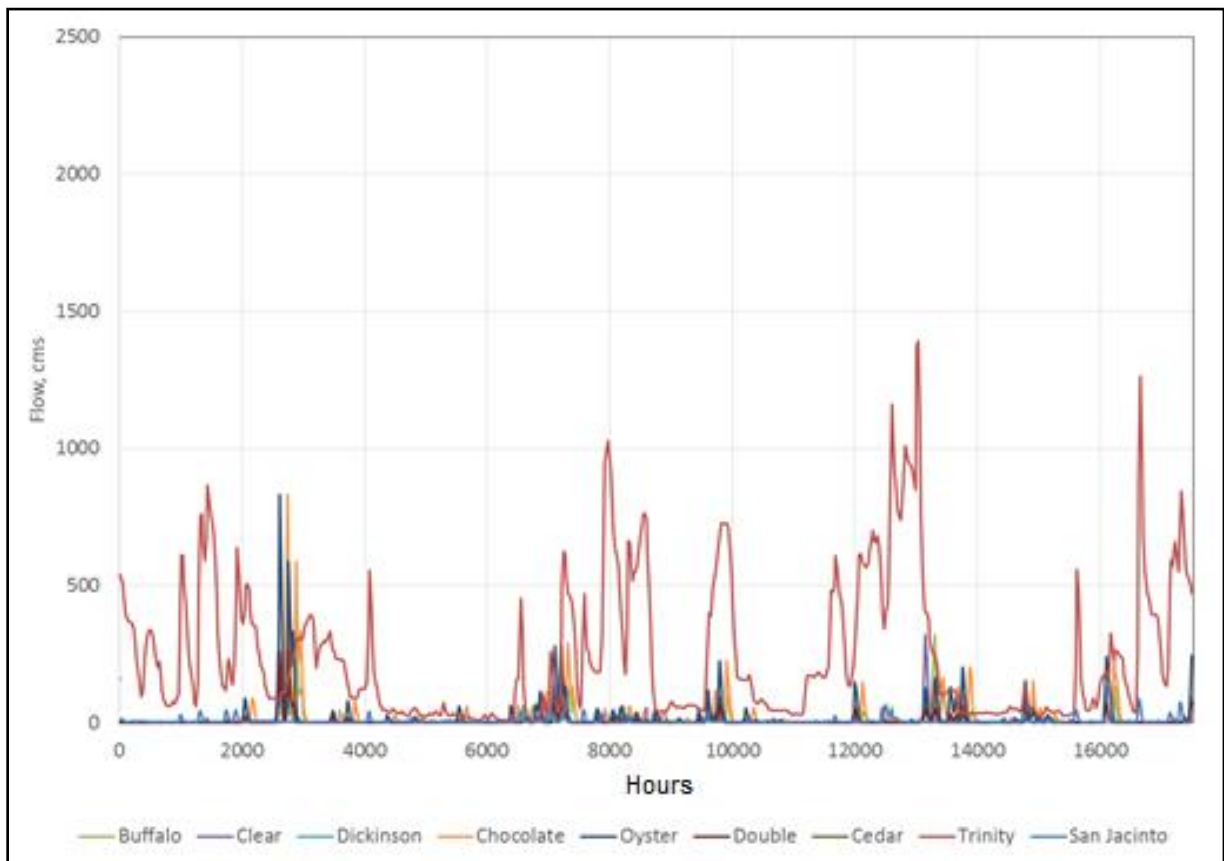

Figure 2-42: Year 2035 (present) Freshwater Inflows

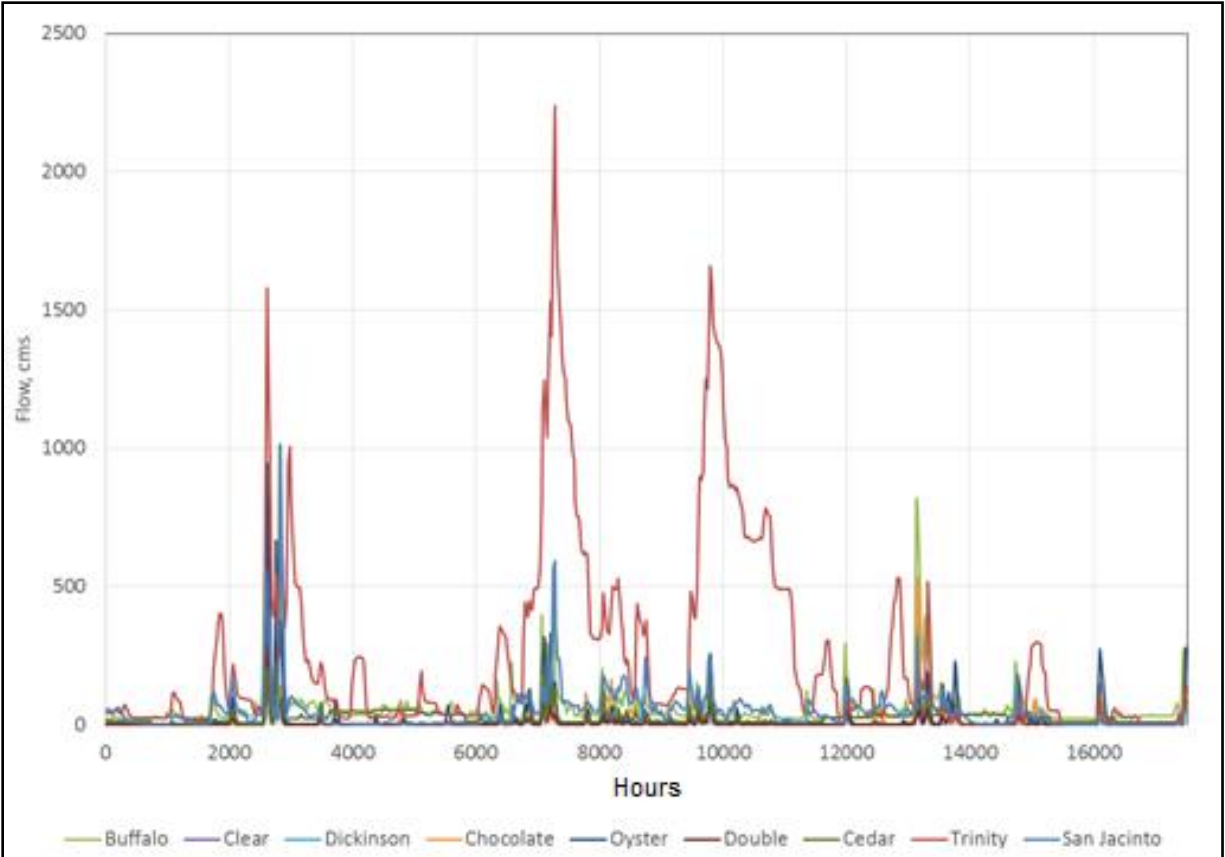

Figure 2-43: Year 2085 (future) Freshwater Inflows

2.8.3 **Hydrodynamic Model Results**

The two alternatives – present without project (PWOP) and present with project (2019PWP) – are simulated using the 3D AdH model. Present condition is referenced at year 2035. The results include changes in salinity, velocity, and water level throughout the model domain under the alternative conditions. The results provided in this section are for a one-year analysis period.

Several locations are identified for specific analysis such as time history, percent less than, and maximum/minimum/average computations of salinity and velocity magnitude. These locations are also used to analyze tidal amplitude changes. These locations are shown in Figure 2-44 and labeled in Table 2-17. These locations were identified through coordination with resource agencies and stakeholder’s inputs. Representative locations, the circled points and the shaded rows in Table 2-17, are included in this report text. Analysis plots and images for all locations are included in the Annex 6 (Galveston Bay Larval Transport Study by ERDC).

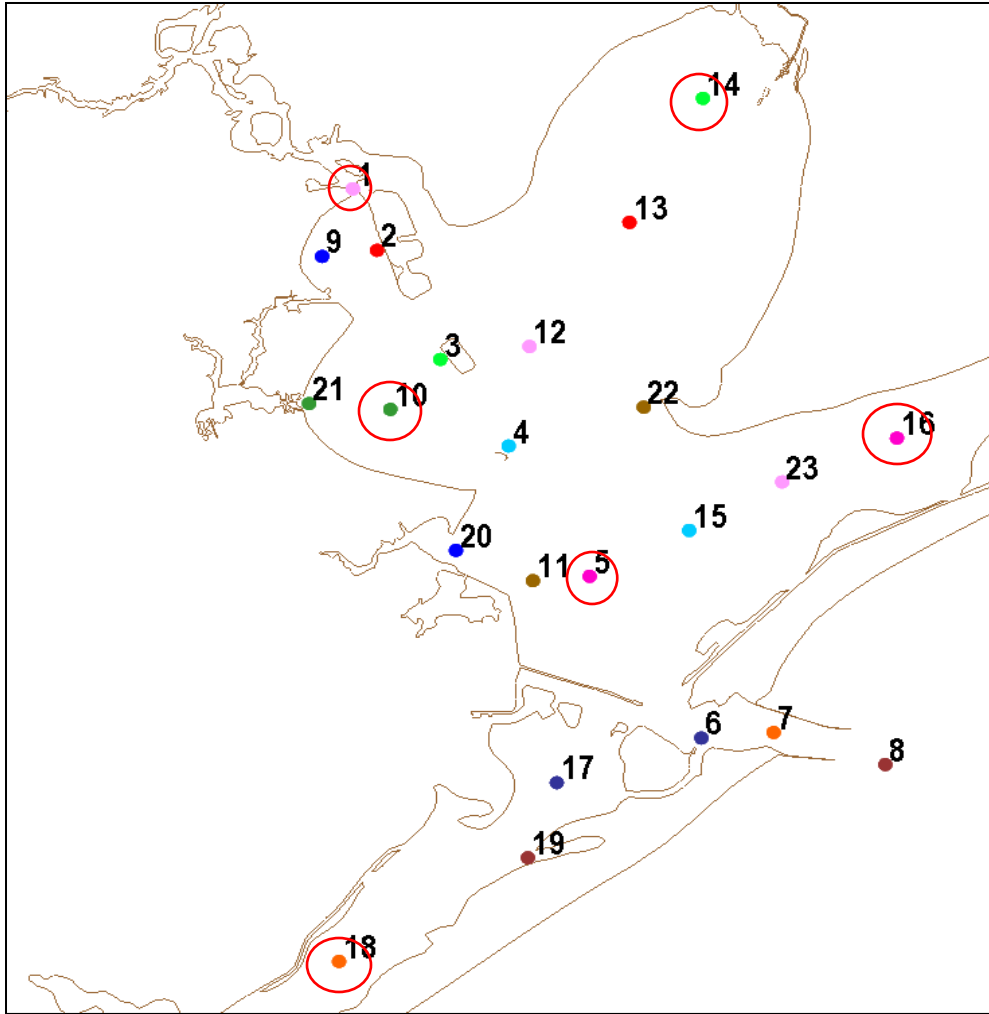

Figure 2-44: Point analysis locations. Circled locations discussed in this section.

Table 2-17: Point analysis location names.

Point #	Name	Point #	Name
1	HSC at Morgan's Point	13	Mid Trinity Bay
2	HSC at Atkinson Island	14	Upper Trinity Bay
3	HSC at Mid Bay Marsh	15	Western East Bay
4	HSC at Red Fish Reef	16	Eastern East Bay
5	HSC at Lower Galveston Bay	17	Eastern West Bay
6	HSC at Bolivar Roads	18	Mid West Bay
7	HSC at Entrance	19	Offatts Bayou
8	HSC at Gulf	20	Dickinson
9	Upper Galveston Bay 1	21	Clear Lake
10	Upper Galveston Bay 2	22	Smith Point
11	Lower Galveston Bay	23	Mid East Bay
12	Lower Trinity Bay		

2.8.3.1 Tidal Prism and Amplitude

Changes to the system geometry can impact the tidal exchange in Galveston and Trinity Bays. The modified TSP alternative impacts the cross-sectional area of the entrance channel which has the potential to cause changes in the volume of flow being exchanged through the inlets. The tidal prism is the difference in water volume between a tidal cycle. This volume is computed over the analysis year and the average tidal prism is then determined. Table 2-18 shows the volume of the average tidal prism for each alternative as well as the percentage change in the with-project alternative as compared to the without project alternative. This approach has been taken at several representative locations.

Results show that the reduction of tidal prism varies between 3 and 7 percent – indicating that the structures are slightly restricting the flow in and out of Bolivar Roads.

Table 2-18: Average tidal prism volume for analysis year.

	PWP (m³)	PWOP Re-Run (m³)	PWP % change from PWOP
Bolivar Roads	509,068,923	526,009,862	-3.22
Offatts Bayou	1,211,965	1,261,998	-4.00
Dickinson Bay	535,201	572,211	-6.47
Clear Lake	3,411,910	3,541,595	-3.66

The tidal amplitude is the change in the water level from low tide to high tide and vice versa. The tidal prism gives an overall impact on the water exchange whereas the tidal amplitude may vary at locations depending on changes in the flow patterns within the system and where the system modifications are made. Figure 2-45 show the percentage change between with and without project alternatives. Table 2-19 summarizes results.

The tidal amplitude comparisons between with and without project range between +3% and -6% (1 to 2 cm). The Gulf of Mexico location shows unchanged tidal amplitudes and the Bolivar Road location shows an increase in the with-project amplitude which is expected since the restriction in the flow area will force water to pile up on the Gulf side of the project. The greatest changes are observed at Bolivar Roads, which is the location closest to the project site on the bay side. All bay side locations show slight decrease in the tidal amplitude for the with-project condition as compared to the without project condition. However, amplitude changes are in the order of 1 to 2 cm as shown in Table 2-19.

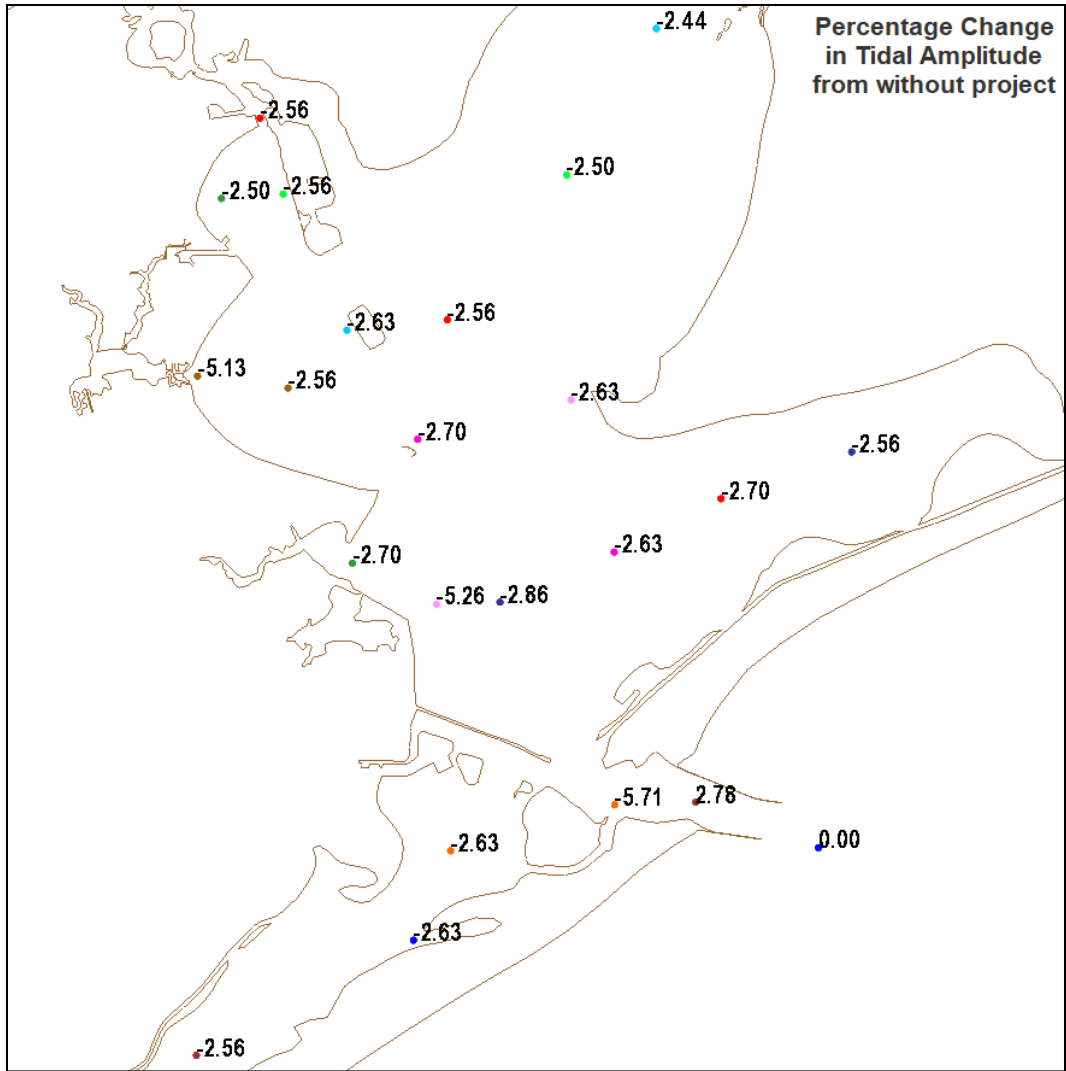

Figure 2-45: Percent Change in Tidal Amplitude for 2019PWP from PWOP

Table 2-19: Tidal Amplitude and Percent Change from the Without-Project Alternatives.

	PWOP Rerun Amplitude (m)	2019PWP Amplitude (m)	2019PWP % change from without project
HSC at Morgan's Point	0.39	0.38	-2.56
HSC at Atkinson Island	0.39	0.38	-2.56
HSC at Mid Bay Marsh	0.39	0.37	-5.13
HSC at Red Fish Reef	0.37	0.36	-2.70
HSC at Lower Galveston Bay	0.35	0.34	-2.86
HSC at Bolivar Roads	0.35	0.33	-5.71
HSC at Entrance	0.36	0.37	2.78
HSC at Gulf	0.42	0.42	0.00
Upper Galveston Bay 1	0.4	0.39	-2.50
Upper Galveston Bay 2	0.39	0.38	-2.56
Lower Galveston Bay	0.38	0.36	-5.26
Lower Trinity Bay	0.39	0.38	-2.56
Mid Trinity Bay	0.4	0.39	-2.50
Upper Trinity Bay	0.41	0.4	-2.44
Western East Bay	0.38	0.37	-2.63
Eastern East Bay	0.39	0.38	-2.56
Eastern West Bay	0.38	0.37	-2.63
Mid-West Bay	0.39	0.38	-2.56
Offatts Bayou	0.38	0.37	-2.63
Dickinson	0.37	0.36	-2.70
Clear Lake	0.39	0.37	-5.13
Smith Point	0.38	0.37	-2.63
Mid-East Bay	0.37	0.36	-2.70

2.8.3.2 Salinity Analyses

The variation in salinity between with and without project alternatives is fairly small for most locations over the simulation year – generally less than 2 ppt. The salinities are almost identical near the Bolivar entrance but begin to slightly change further into the system at Mid Bay Marsh and Morgan’s Point. However, the change in the mean salinity between with and without project remains within 2 ppt. The maximum salinity comparisons between with-project and without-project are slightly higher for some locations but still less than a 5 ppt difference. Figure 2-46 and Table 2-20 give the mean bottom salinity for the analysis locations as well as the change in the mean salinity due to the project conditions.

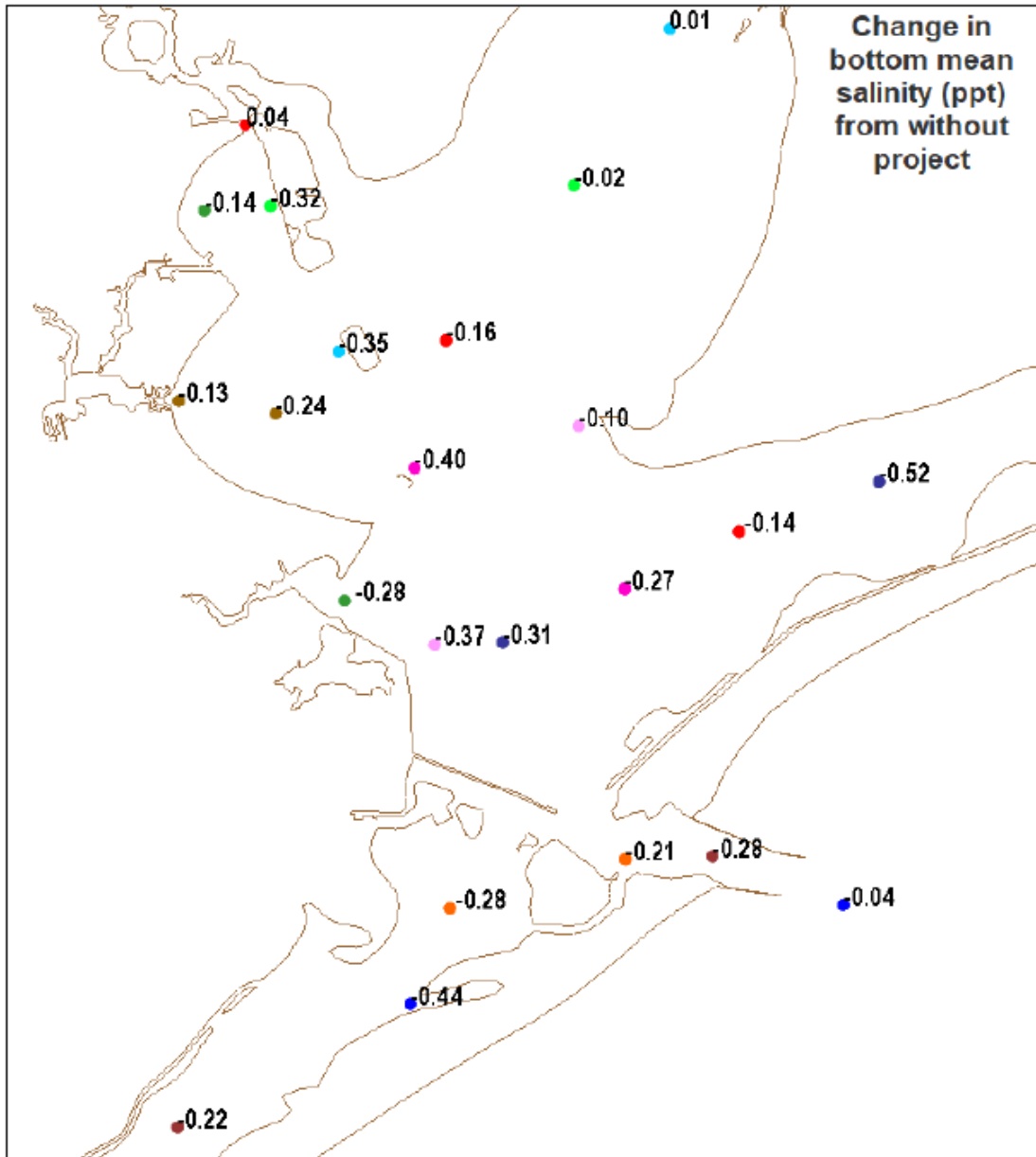

Figure 2-46: Change in Bottom Salinity for 2019PWP from PWOP

Table 2-20: Bottom Salinity Change from the Without-Project Alternatives.

	PWOP Rerun Mean Bottom Salinity (ppt)	2019PWP Mean Bottom Salinity (ppt)	2019PWP change (ppt) from without project
HSC at Morgan's Point	21.04	21.07	0.04
HSC at Atkinson Island	22.18	21.86	-0.32
HSC at Mid Bay Marsh	23.67	23.32	-0.35
HSC at Red Fish Reef	25.38	24.98	-0.40
HSC at Lower Galveston Bay	26.79	26.48	-0.31
HSC at Bolivar Roads	27.66	27.45	-0.21
HSC at Entrance	28.24	27.96	-0.28
HSC at Gulf	29.98	29.94	-0.04
Upper Galveston Bay 1	17.84	17.70	-0.14
Upper Galveston Bay 2	18.70	18.46	-0.24
Lower Galveston Bay	18.00	17.62	-0.37
Lower Trinity Bay	14.99	14.82	-0.16
Mid Trinity Bay	9.46	9.45	-0.02
Upper Trinity Bay	3.22	3.24	0.01
Western East Bay	11.71	11.43	-0.27
Eastern East Bay	6.60	6.08	-0.52
Eastern West Bay	21.66	21.38	-0.28
Mid West Bay	21.17	20.95	-0.22
Offatts Bayou	21.64	21.20	-0.44
Dickinson	13.41	13.13	-0.28
Clear Creek	13.92	13.79	-0.13
Smith Point	7.38	7.28	-0.10
Mid East Bay	5.73	5.59	-0.14

2.8.3.3 Velocity Analyses

As with the salinity analysis, the velocity magnitudes for the with-project condition do not vary greatly at different locations in the bays. The velocity magnitudes slightly drop at most locations for both surface and bottom but this reduction in the mean velocity magnitude is less than 0.1 cm/s and typically more on the order of 0.05 cm/s or less, which is negligible. Figure 2-47 shows surface velocity changes from the without project condition.

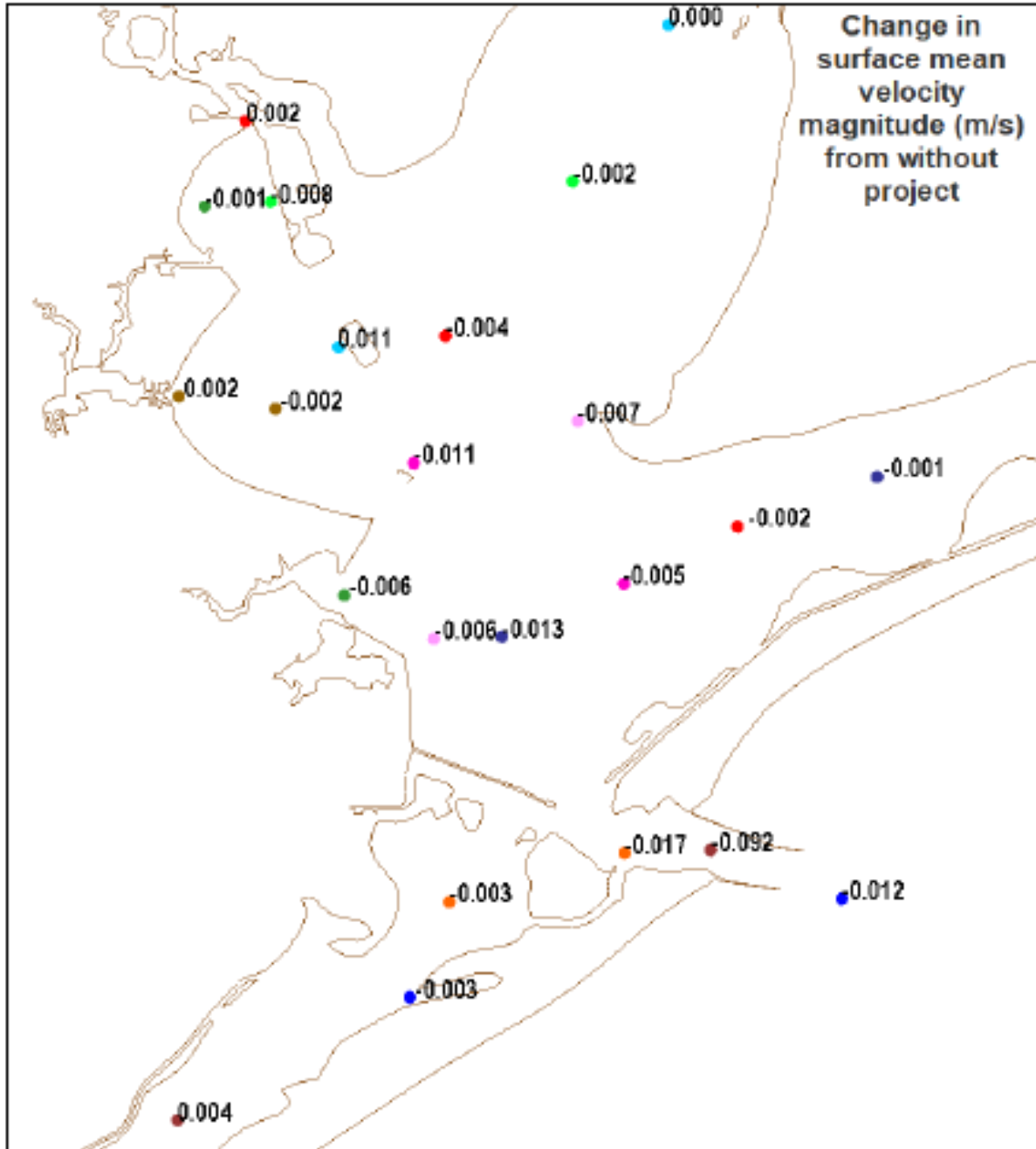

Figure 2-47: Change in Surface Velocity for 2019PWP from PWOP

2.8.4 Larval Transport

Characteristic larval marine species transport was modeled using the Particle Tracking Model (PTM). A five-week period was simulated using AdH Hydro as input and particles which had specific characteristic behaviors: passive, tidal vertical, diel vertical, bottom dwellers, top dwellers, and tidal lateral. Comparison of the impact of the added structure on larval marine species transport within the

area are available in the Annex in the form of particle position maps, time series of recruitment, and graphs of the number of recruited particles based on specific characteristics such as behaviors and where recruitment occurred.

Results showed very little difference between with-structure and base conditions. A sensitivity simulation was performed which showed the differences were within the uncertainty of the model. The similarities were supported by the tidal prism results. The gate structure was added with the specific plan that the overall volume of flow into the system would remain relatively constant. For the simulated conditions within this work, this impacted the transport of the with-gate condition, such that there was no real change in recruitment. Rollover Pass is currently a closed system. However, for the time frame of the hydrodynamics modeled, it has been left open. A recruitment trap was placed at Rollover Pass to determine if there was a significant percentage of particles that might enter into East Bay through this pass. Results show (See Figure 5-4 in the Annex report) that there are small amounts of particles that are transported through Rollover Pass, but not enough to significantly impact overall statistics. Figure 2-48 shows a comparison at two weeks of the a) base condition and b) with project condition. Qualitatively the two cases appear to be very similar. The overall transport trends are the same: 1) pathway of particles moving within navigation channel to Trinity Bay, 2) transport of particles along the shoreline, 3) transport towards West Bay, and 4) few particles moving towards East Bay. Because particle recruitment is dependent on the Lagrangian transport algorithm which have several random parameters, the same initial conditions can produce slightly different results. The primary source of the randomness is from the random walk diffusion subroutine contained within the model (King and Lackey 2015), but there is also randomness that occurs as particles interact with boundaries. A series of simulations is performed to determine the impact of the randomness on recruitment and to see if differences between the base case and with project case are within the sensitivity of the results. Figure 2-49 shows the outcome of the 12 simulations (six with the base condition, and six with the with-project condition). The differences between the with-project and without-project results fall within the sensitivity of the model runs, thus the model results are considered very comparable.

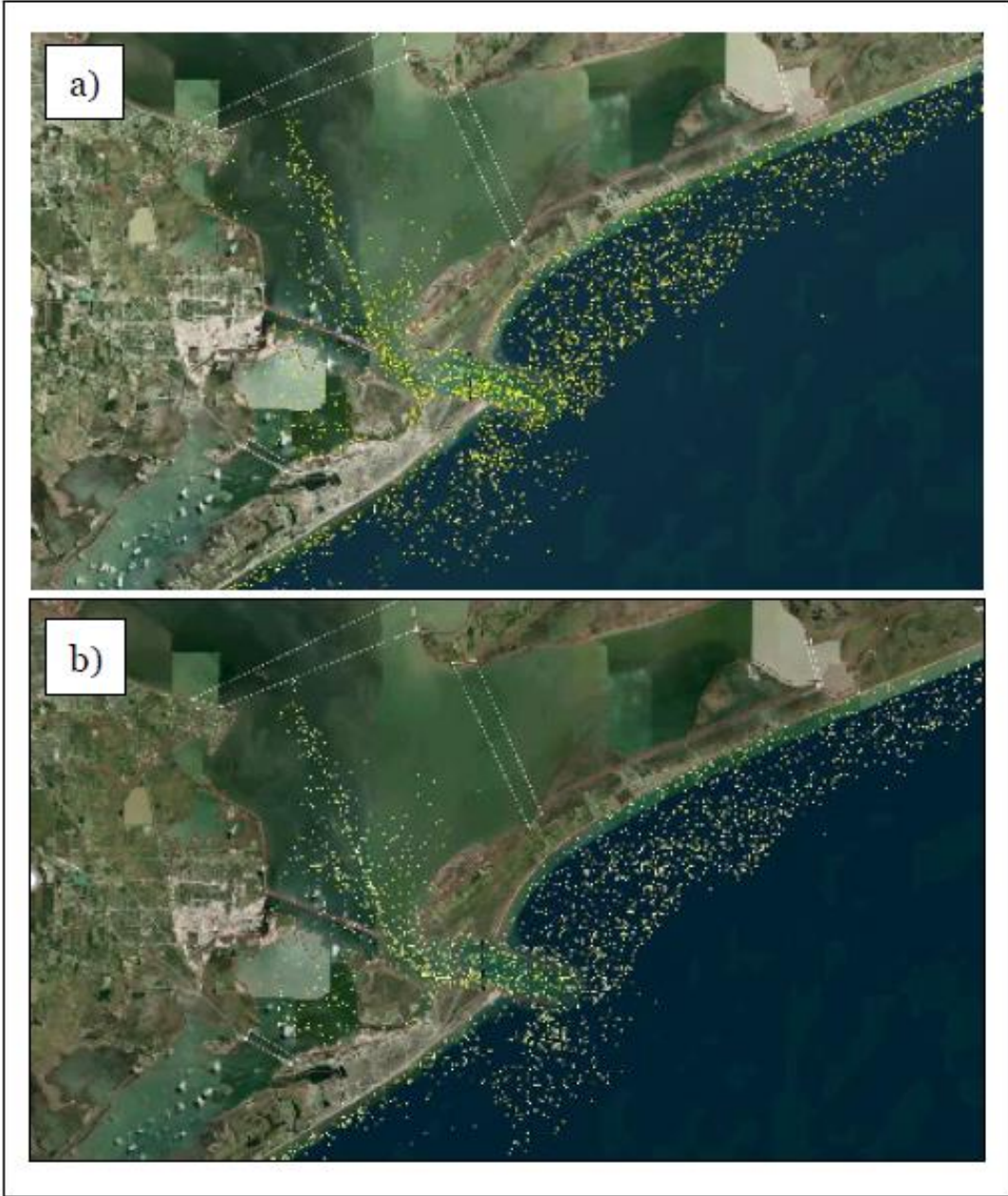

Figure 2-48: Comparison of Recruitment a) base condition and b) with-project conditions

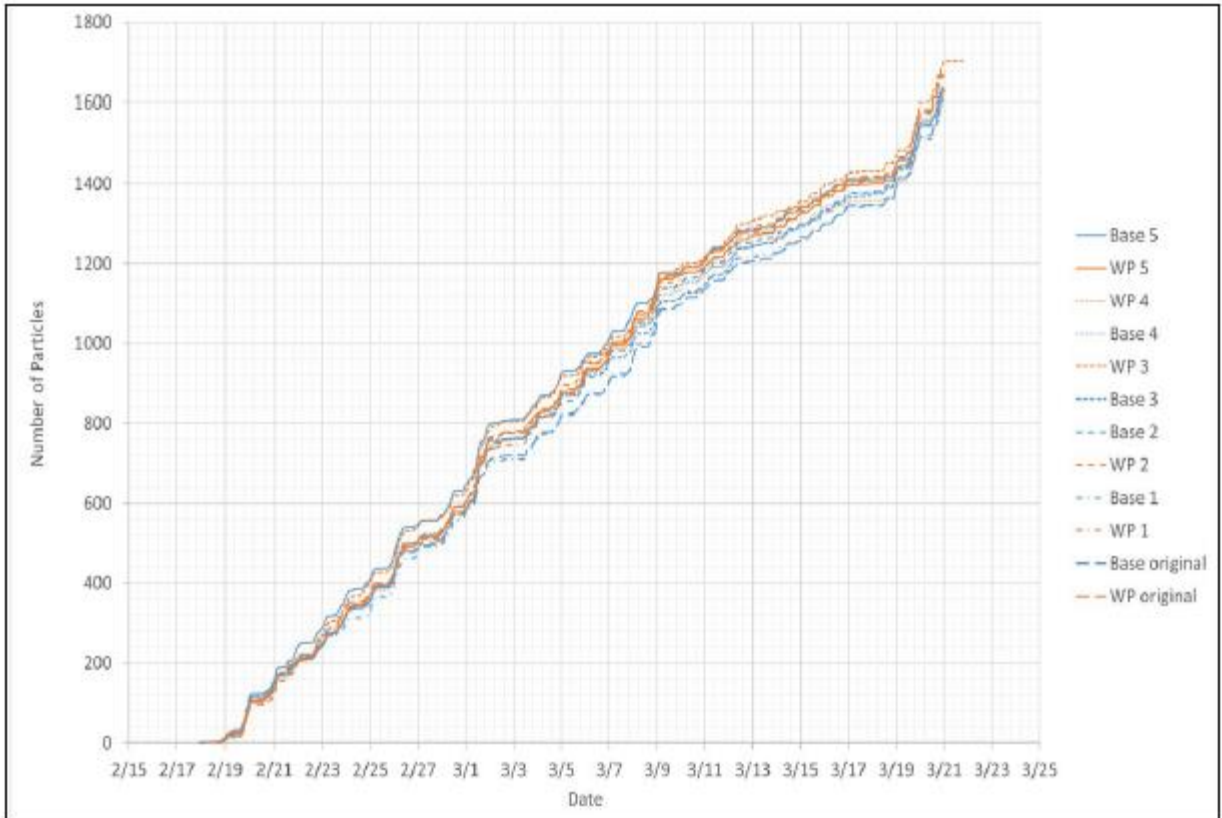

Figure 2-49: Outcome of PTM sensitivity simulations for without-project or base conditions (blue) and with-project conditions (WP) (orange).

2.8.5 Environmental Modeling Discussion

The four alternatives – present without-project and present with-project and future without-project and future with-project – are simulated over a two-year period with the first year for salinity initialization and the second year for analysis of hydrodynamic and salinity results. Overall, this alternative had little effect on bay salinity and velocity patterns. On average, the salinity did not vary by more than 2 ppt between with and without project conditions at any location. The velocity magnitudes vary little (less than 0.1 cm/s) between with and without-project conditions for locations away from the gated structure.

Results showed very little difference between with-structure and base conditions. The hydrodynamics at the location of the gated structure show slight increase in velocity magnitudes due to eddy formations, and slight increase in water surface elevation across the structures. These patterns should be reviewed in coordination with navigation requirements such that the RP design provides for safe navigation throughout the typical tidal conditions for the area. It is understood that more detailed and advanced physical and computational modeling will be conducted during the PED phase to resolve the 3D circulation and forcing around the gated structure.

3.0 GEOTECHNICAL

3.1 SCOPE OF WORK

The objective of this section is to provide a detailed background of the geotechnical engineering work performed for the feasibility-level design of features included in the Recommended Plan for the subject Study. The Recommended Plan includes Coastal Storm Risk Management (CSRМ) systems that would protect the coastal parts of the study area and associated Ecosystem Restoration (ER) system. This section focuses on geotechnical design assumptions and foundation conditions, with discussion of environmental impacts during construction and evaluated risk levels associated with subsurface uncertainties. The feasibility-level design followed appropriate engineering assumptions and design strategies to mitigate risks related to potential uncertainties related to subsurface conditions. Consistency in the level of detail for geotechnical evaluation of features varies due to lack of recent site investigation in the area of some features. However, the available geotechnical data is considered adequate for meeting the study requirements.

3.2 DOMAIN

This geotechnical documentation captures the conceptual design for CSRМ and ER systems included in the recommended plan identified in the Feasibility Report (FR). This document presents and describes the design assumptions, criteria, and results of the geotechnical analyses performed for the feasibility-level geotechnical design of CSRМ system features. Details of the CSRМ features are presented in Civil and Structural Chapters of the Feasibility Report (FR) Engineering Appendix. Details of the ER features are presented in Recommended Plan: Ecosystem Restoration Chapter of the Feasibility Report (FR) Engineering Appendix.

The proposed CSRМ system includes the Galveston Harbor Entrance Channel Crossing, West Galveston Island Beach and Dune System, Bolivar Peninsula Beach and Dune System, City of Galveston Barrier, Clear Lake Gate and Pump Station, and Dickinson Gate and Pump Station. The CSRМ and ER systems are further detailed in the Map books (Section 4.0).

The features of recommended CSRМ and ER systems are as follows:

- 1) Galveston Harbor Entrance Channel Crossing. (See Figure 3-1).
 - Navigation & Environmental Gates (650-foot Sector Gates with Sill Ele. -60, Artificial Islands, Vertical Lift Gates with Sill Ele. -40, Vertical Lift Gates with Sill Ele. -20, 125-foot Sector Gate with Sill Ele. -40, Shallow Water Environmental Gates with Sill Ele. -5)
 - Levee
 - Combi-Wall



Figure 3-1: Galveston Harbor Entrance Channel Crossing

2) Natural/Fortified Beach and Dune System

- Bolivar Peninsula Beach and Dune System. (See Figure 3-2 for details).
- West Galveston Island Beach and Dune System. (See Figure 3-3 for details).
- South Padre Island Beach and Dune Nourishment. (See Figure 3-4 for details).

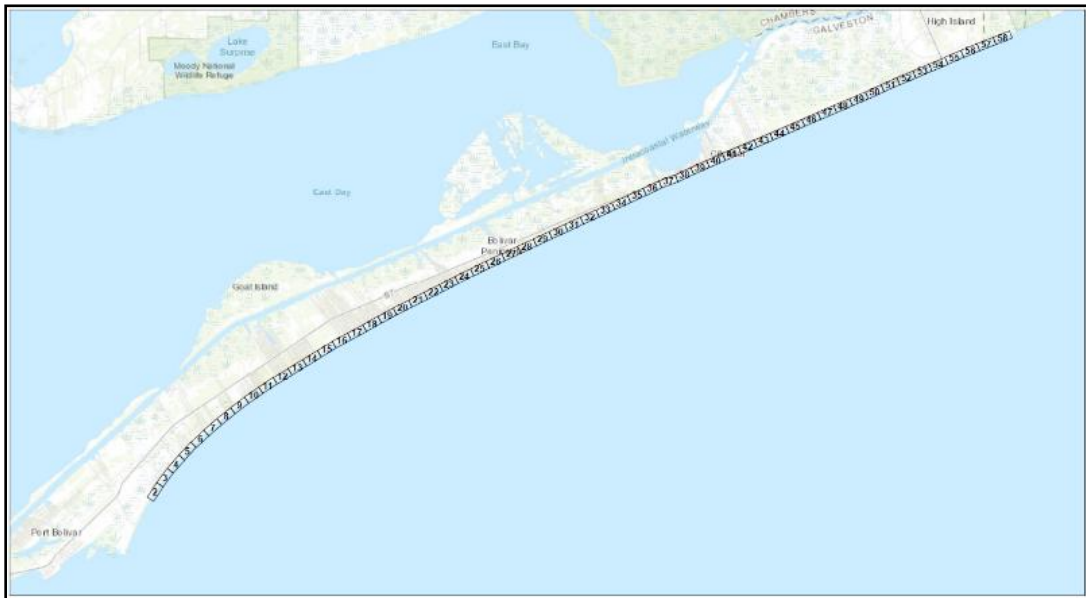

Figure 3-2: Bolivar Peninsula Beach and Dune System



Figure 3-3: Galveston Island Beach and Dune System



Figure 3-4: South Padre Island Beach and Dune Nourishment.

3) City of Galveston Barrier

- Galveston Seawall Reach. (See Figure 3-5 for details).



Figure 3-5: Galveston Seawall Reach.

- City of Galveston Barrier Outside of Seawall Portion.
Combi-wall, existing levee, Floodwall Reach, Circulation Gate, Navigation Gate.
(See Figure 3-6 for details).

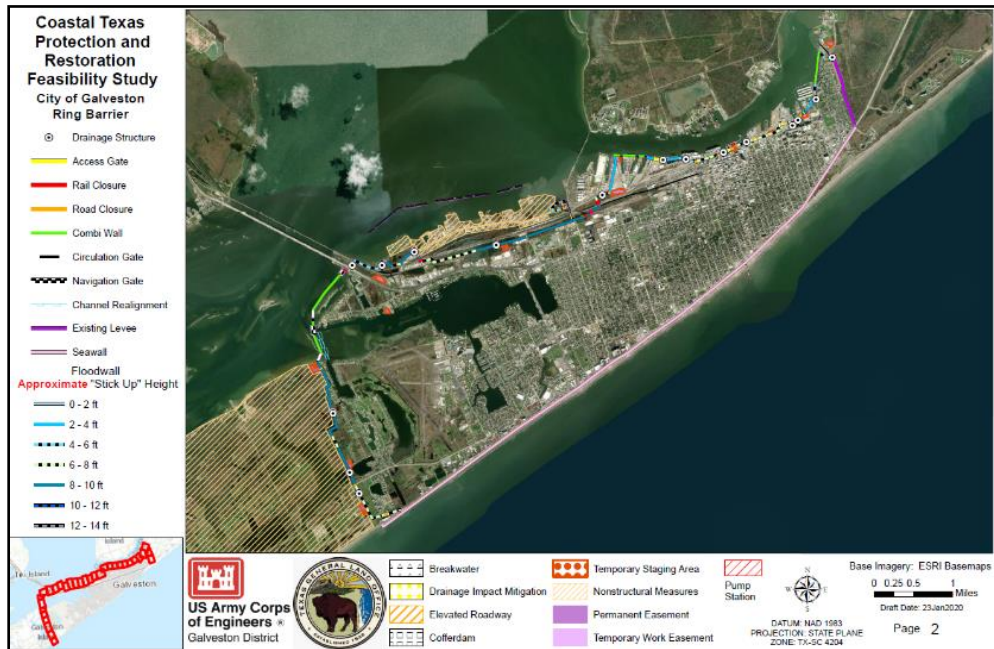

Figure 3-6: City of Galveston Ring Barrier (Outside of Seawall Portion)

4) Gate and Pump Station

- Clear Lake Gate and Pump Station. (See Annex 7, Annex 8 for details).
- Dickinson Gate and Pump Station. (See Annex 7, Annex 8 for details).

5) The Ecosystem Restoration (ER) features. See Figure 3-7 for details.

- G-5 – Bolivar Peninsula/Galveston Island Gulf Beach and Dune Restoration
- G-28 – Bolivar Peninsula and West Bay GIWW Shoreline and Island Protection
- B-2 – Follets Island Gulf Beach and Dune Restoration
- B-12 – Bastrop Bay, Oyster Lake, West Bay, and GIWW Shoreline Protection
- M-8 – East Matagorda Bay Shoreline Protection
- CA-5 – Keller Bay Restoration
- CA-6 – Powderhorn Shoreline Protection and Wetland Restoration
- SP-1 – Redfish Bay Protection and Enhancement
- W-3 – Port Mansfield Channel and Island Rookery Restoration

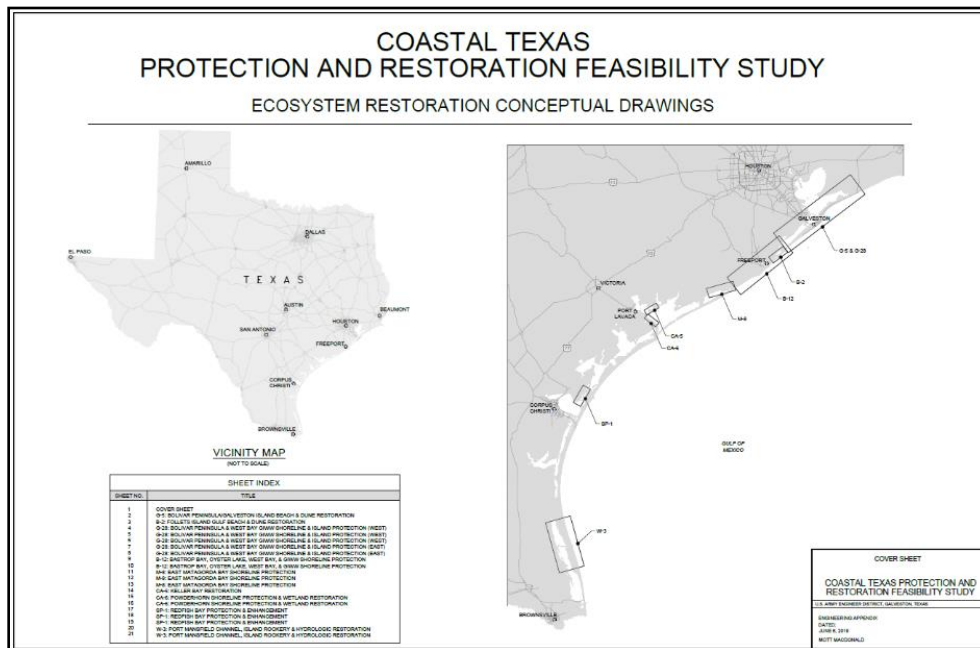

Figure 3-7: Ecosystem Restoration (ER) features.

3.3 **DESIGN CRITERIA**

3.3.1 **Selection of Design Criteria**

Per Table B-1 of Engineer Regulation 1110-2-1806, the recommended CSRSM System would be classified as a high hazard structure. The design criteria for this system are included in the following reference documents:

- 1) Hurricane and Storm Damage Risk Reduction System Design Guidelines, INTERIM, June 2012
- 2) Engineering Manual (EM) 1110-2-1913, Design and Construction of Levees, April 2000
- 3) Engineering Manual (EM) 1110-1-1804, Geotechnical Investigations, January 1, 2001
- 4) Engineering Manual (EM) 1110-2-1906, Laboratory Soils Testing, August 20, 1986
- 5) Engineer Regulation 1110-1-12, Quality Management, July 21, 2006
- 6) Engineer Regulation 1110-2-1806, Earthquake Design and Evaluation for Civil Works Projects, May 31, 2016
- 7) Engineer Regulation 1110-2-1407 Hydraulic Design for Coastal Shore Protection Projects, November 30, 1977
- 8) Engineer Regulation 1110-2-8159 Life Cycle Design and Performance, October 31, 1997
- 9) Engineer Regulation 1130- 2-406 Shoreline Management at Civil Works Projects, October 31, 1990 and May 28, 1999
- 10) Engineer Regulation 1110-2-1150 Engineering and Design for Civil Works Projects, August 1999

3.3.2 **Historical Documentation and Input Data**

Feasibility level engineering included a review of historical, relevant, and useful documentation. Geotechnical data were obtained from the USACE, Gulf Coast Community Protection and Recovery District (GCCPRD), TxDOT, Port Freeport, GLO, and Galveston County. GCCPRD Preliminary Geotechnical Report Storm Surge Suppression Study – GCCPRD Brazoria, Chambers, Galveston, Harris, Jefferson, and Orange Counties dated October 18, 2017 was particularly useful in developing conceptual level designs.

3.3.3 **Reference Documents**

3.3.3.1 **USACE Engineer Manuals**

Relevant USACE Engineer Manuals are listed in Design Criteria section of this chapter.

3.3.3.2 USACE Engineer Regulations

Relevant USACE Engineer Regulations are listed in Design Criteria section of this chapter.

3.3.3.3 Other USACE Engineering Guidelines

Relevant USACE Engineering Guideline is listed in Design Criteria section of this chapter.

3.3.3.4 Project Geotechnical Data

Appendix H of the GCCPRD Preliminary Geotechnical Report Storm Surge Suppression Study – GCCPRD Brazoria, Chambers, Galveston, Harris, Jefferson, and Orange Counties dated October 18, 2017 (FUGRO/GCCPRD 2017). This document summarized the available geotechnical data for the study area. This document is included as an attachment to the Feasibility Report (FR) (Annex 9).

3.3.3.5 Conceptual Design Reports

Tetra Tech/Mott MacDonald, GLO Draft Report Engineering Design Criteria - Coastal Texas Protection and Restoration Feasibility Study dated November 09, 2018 (Tetra Tech/Mott MacDonald 2018). This document presents the design criteria for selected features for the subject study. This document is included as an attachment to the Feasibility Report (FR) (Annex 8).

3.3.4 Regional Geology

The relevant engineering geology including potential geologic hazards for the study area were evaluated and are presented in Section 2.0 of FUGRO/GCCPRD 2017 report (Annex 9. Figure 3-8 and Figure 3-9 present the relevant general soil maps for the project sites.

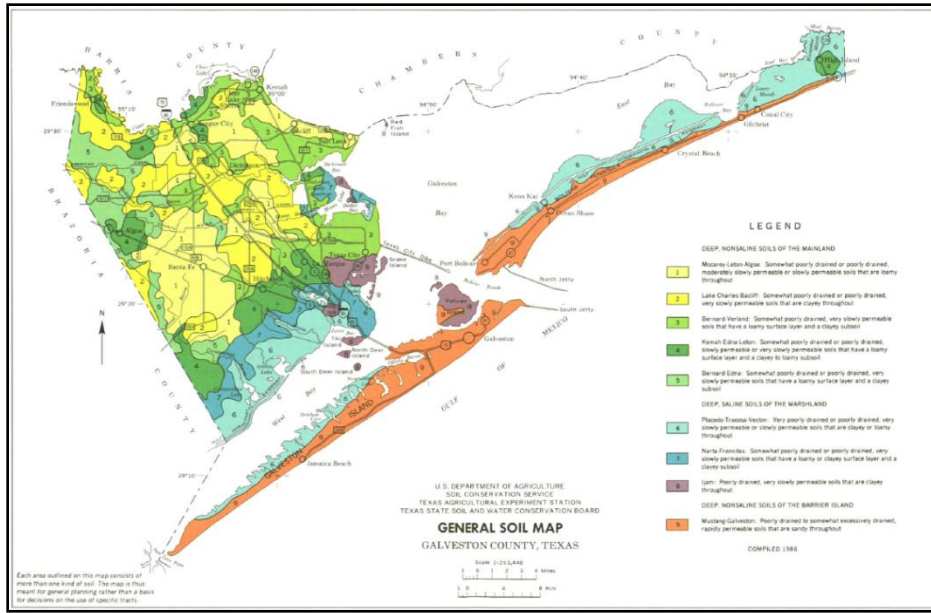

Figure 3-8: General Soil Map, Galveston County, Texas.

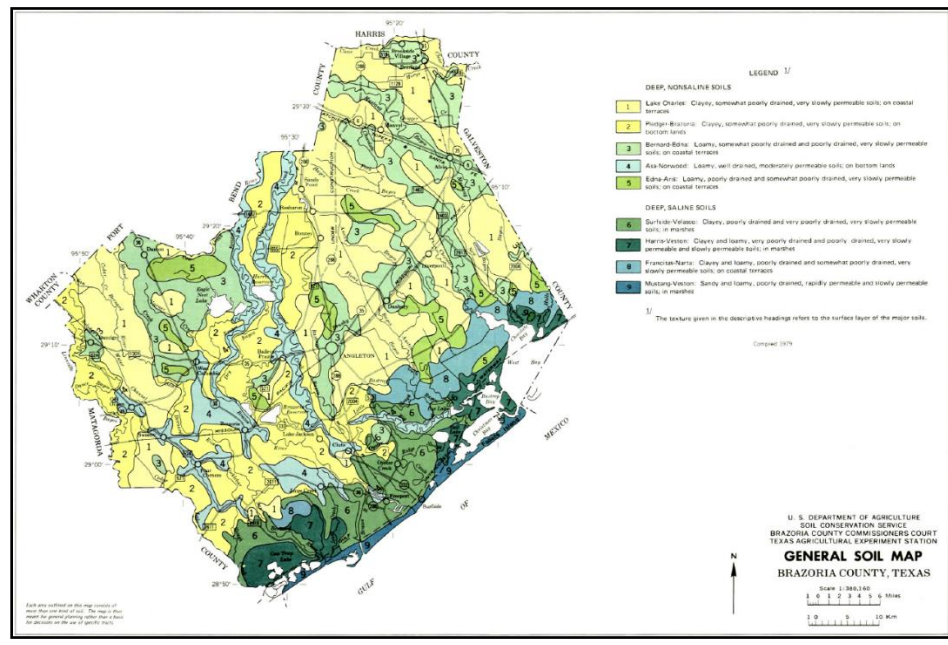

Figure 3-9: General Soil Map, Brazoria County, Texas.

The summary of the project potential geologic hazards is listed as below:

- Surface Faulting – No Seismic hazards, and the project site is not in proximity to known growth faults.
- Subsidence – No significant subsidence in the future if groundwater pumpage and oil and gas withdrawal are maintained at current levels.

- Expansive Soils – Applicable to Shallow Foundation elements, replace upper 2-foot of soils with engineered fill.
- Karst - Not applicable to the Project
- Collapsible Soils- Not applicable to the Project

3.3.5 **Engineering Software**

GeoStudio Suite is commercially available software that was used to analyze the stability of slopes. The deep foundation analyses and shoring design for deep excavations were performed using verified spreadsheets which were developed per project design criteria. USACE CASE programs (CCELL, CWALSHT) were used for analyzing cellular sheet pile bulkhead structures and shoring design for deep excavations.

3.4 **GEOTECHNICAL EVALUATION**

3.4.1 **Subsurface Conditions for CSRМ System Features**

Subsurface conditions described below are derived mostly from existing data as limited investigations were done for this study. Foundations conditions associated with each CSRМ system features are summarized in the following sections.

3.4.1.1 **Galveston Seawall Reach and West Galveston Island Beach and Dune System**

In general, the surficial and subsurface soils are deep non-saline soils of barrier land (predominantly clayey, sandy, silty soils) per General Soil Map for Galveston County prepared by U.S. Department of Agriculture (USDA) Soil Conservation Service (SCS) compiled in 1986. The available geotechnical data shows that the upper 20 to 38 feet of topsoils consist of very loose to medium-dense granular soils like sands, silty sands, sandy silts, and clayey sands as primarily observed in relevant borings and cone penetration tests (CPTs). The upper granular soil layer is underlain by natural cohesive soils and natural cohesionless soils with interbedded granular sand layers to a depth of about 60 feet below existing grade.

Subsurface conditions along Galveston Seawall Reach and West of Galveston Island Beach and Dune System are presented in Plate 5b of FUGRO/GCCPRD 2017 report (Annex 9). The subsurface conditions are developed based on the actual field investigation and results from associated laboratory tests conducted on soil samples from the borings drilled along this alignment. The subject alignment soil stratigraphy was developed based on soil borings BH-03 through BH-05 and CPT soundings CPT-24 through CPT-39 as shown on Figure 3-10. The following is the summary of the log of borings and laboratory findings.

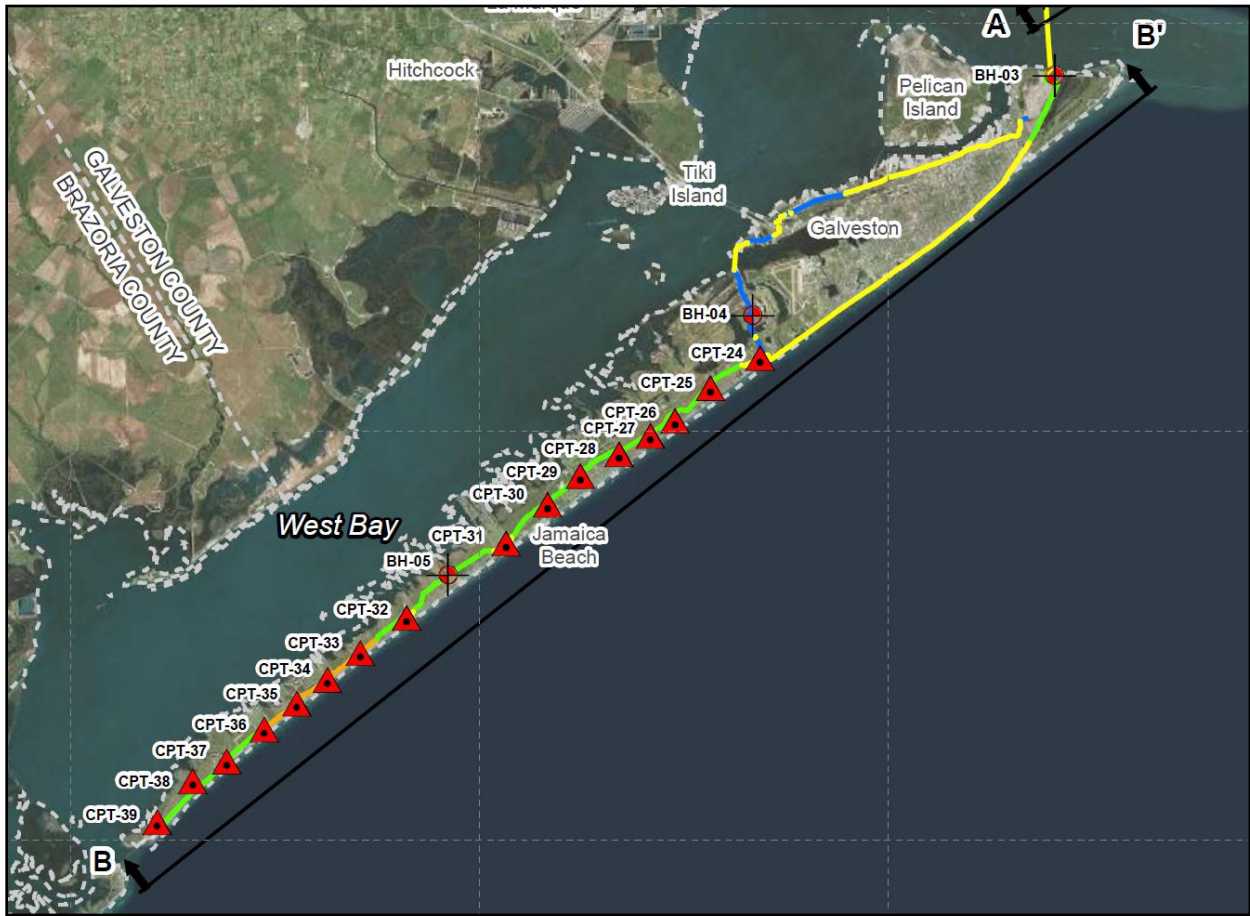

Figure 3-10: Boring Plan on Galveston Island (Sea Wall to San Luis Pass)

(Source: GCCPRD, 2017)

The proposed Galveston Seawall Improvements include building the seawall overtopping reduction feature (to El +21 MLLW) along the seawall boulevard as detailed in the seawall improvements map book attached with the study report (Section 4.0). In general, the adjacent ground surface conditions are relatively flat, and the existing seawall foundation can carry the anticipated additional loading. The existing seawall system includes either riprap or beach in front of the seawall, which is necessary to minimize erosion of the seawall foundation soils.

The West Galveston dune system would start at the end of the Galveston Seawall and continue westerly for 20.0 miles ending at the San Luis Pass. The West Galveston dune system is a dune field system consisting of 18.4 miles of sand dune, of which 1.5 miles are within CBRA Zone CBRA WG TX-05P. The dune field system would have a seaward dune elevation of 12.0' and a landward dune elevation of 14.0. The dune system is further detailed in the Galveston Dune System Mapbook (Section 4.0).

3.4.1.2 City of Galveston Barrier Outside of Seawall Portion

Limited soil information exists for the alignment of the City of Galveston Barrier Outside of Seawall Portion. Therefore, feasibility level engineering relies heavily on the General Soil Map for Galveston County prepared by USDA SCS and topographic site maps.

The surficial and subsurface soils are deep non-saline soils of barrier land (clayey, sandy, silty soils) per General Soil Map for Galveston County prepared by USDA SCS compiled in 1986. The existing foundation soils consist of clayey, sandy, and silty soils. The proposed levee/Floodwall is planned to build along the coastline of the island as part of Galveston ring levee.

The features along the City of Galveston Barrier Outside of Seawall Portion consist of existing levee, floodwall, combi-wall, roadway gates, railroad gates, navigation gate, circulation gates to serve navigation or for tidal exchange, drainage closure structures, and pump stations as detailed in the City of Galveston Barrier map book attached with the study report (Section 4.0).

The abovementioned features will be primarily supported on deep foundation systems because of limited space in this highly residential area. The recommended deep foundation systems will require scour protection due to wave action and subsequent erosion potential. The recommended pile foundation system located adjacent to the shoreline will require a riprap cover along the shoreline to minimize the soil erosion within the foundation soils zone. Appendix G of the FUGRO/GCCPRD 2017 report (Annex 9) presents the results of the deep foundation analysis using generalized soil profiles to support the preliminary phase design.

3.4.1.3 Galveston Harbor Entrance Channel Crossing

This alignment starts from the southwestern tip of the Bolivar Peninsula and spans southward and crosses Bolivar Roads for about 2.1 miles and ends at the northern end of Highway 3005. This feature includes Galveston Harbor Entrance Channel gates (surge barrier gates) as a combination of navigational (sector gates) and environmental (vertical lift) gates as detailed in the Galveston Harbor Entrance Channel Crossing map book attached with the study report (Section 4.0).

GCCPRD did recent geotechnical investigations along the Galveston Harbor Entrance Channel where the crossing ties back into land. The geotechnical data from FUGRO/GCCPRD 2017 report and 1972 Galveston Entrance Channel study was used for this study. Subsurface conditions along the Galveston Harbor Entrance Channel Crossing is presented in Plate 5e of FUGRO/GCCPRD 2017 report (Annex 9).

Feasibility level geotechnical analyses for the entrance channel gates (surge barrier gates) were performed using information from two deep borings (BH-02 and BH-03) drilled to a depth of 400 feet below existing grade at Bolivar Peninsula and Galveston Island, five off-shore borings (3ST-1, 6ST-3,

3ST-4, 3ST-5, and 3ST-6) drilled within the Galveston Bay up to elevation below -160 feet as shown on Figure 3-11.

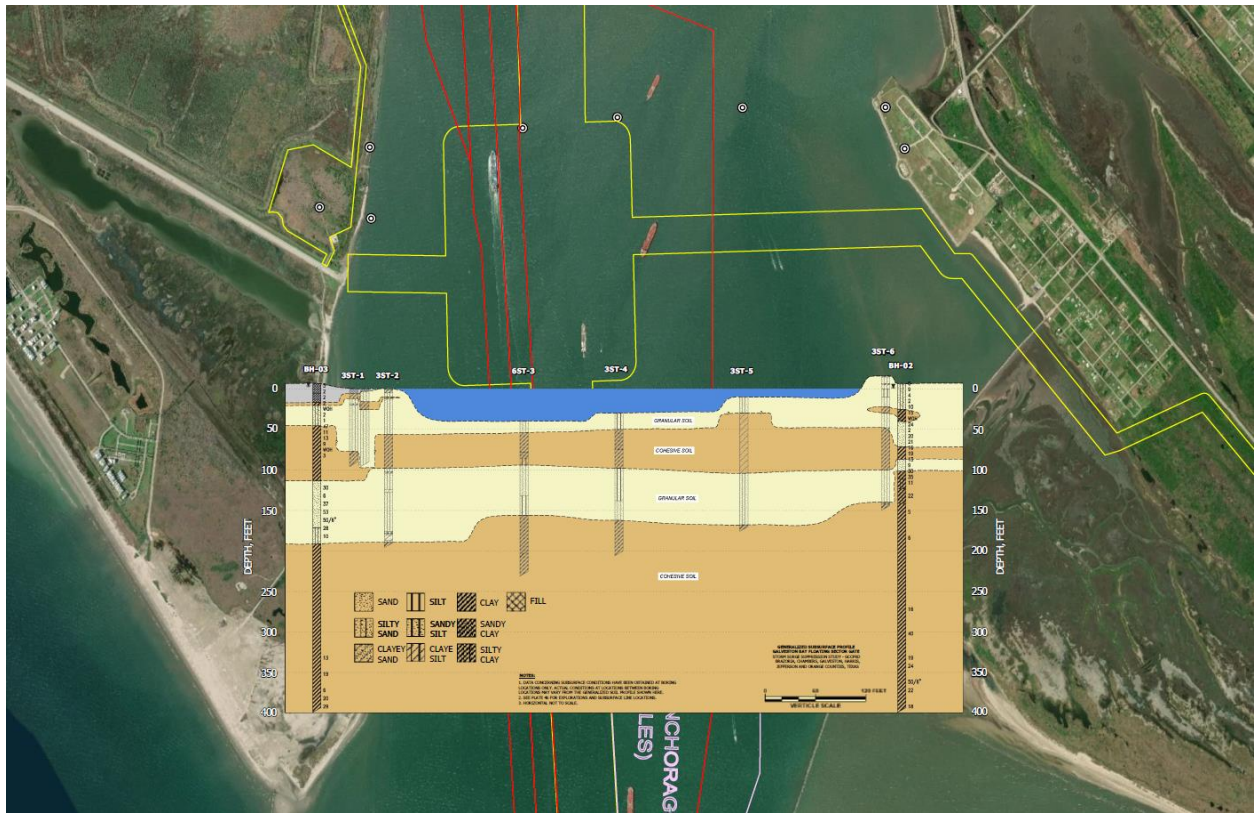

Figure 3-11: Galveston Harbor Entrance Channel Crossing

The conceptual design for the Galveston Harbor Entrance Channel Crossing is a deep foundation system with pile caps founded on a group of vertical and battered piles (driven pipe piles) based on existing foundation soils condition and limited foundation space.

3.4.1.4 Clear Lake Gate and Pump Station

Considerable soil information exists for the preliminary design of the proposed structure in the vicinity of the Clear Lake Gate and Pump Station. Table 1 of the Tetra Tech/Mott MacDonald 2018 Report (Annex 8) presents the list of soil borings considered from the available geotechnical data for preliminary design of the Clear Lake Gate and Pump Station.

The summary of a generalized soil profile developed for the Second Outlet for Clear Lake project (Geotechnical Investigation report dated December 6, 1982) was as follows: the upper 20 feet of subsurface soils included soft clays, soft sandy and silty clays, loose clayey sands, loose clayey silts and loose silty sands. Very soft to medium clays were encountered within depths ranges between 20 and

40-feet. Stiff to hard clays and silty clays were encountered within depths ranges between 40 and 60-feet. A dense to very dense sand was encountered below 60-foot depth during drilling.

The conceptual design for the Clear Lake Crossing is a deep foundation system with pile cap founded on a group of vertical and battered piles (driven pipe piles). The conceptual design of the Clear Lake Gate and Pump Station is further detailed in the Tetra Tech/Mott MacDonald 2018 Report (Annex 8).

3.4.1.5 Dickinson Gate and Pump Station

Considerable soil information exists for the preliminary design of the proposed structure in the vicinity of the Dickinson Gate and Pump Station. Table 1 of the Tetra Tech/Mott MacDonald 2018 Report (Annex 8) presents the list of soil borings considered from the available geotechnical data for the preliminary design of the Clear Lake Gate and Pump Station.

Tetra Tech/Mott MacDonald 2018 Report presents a generalized soil profile (Table 4 of Annex 8) based on available soil borings: the upper 20 feet of subsurface soils included soft clays. Stiff clays were encountered within depths ranges between 20 and 65-feet. Very dense sands were encountered within depths ranges between 65 and 90-feet. Stiff clays were encountered below 90-foot depth during drilling.

The concept design for the Dickinson Gate and Pump Station is a deep foundation system with pile cap founded on a group of vertical and battered piles (driven pipe piles). The concept design of the Dickinson Gate and Pump Station is further detailed in the Tetra Tech/Mott MacDonald 2018 Report (Annex 8).

3.4.1.6 Bolivar Peninsula Beach and Dune System

The Bolivar Peninsula Beach and Dune System starts approximately 2.0 miles east of State Highway 87 and continues southwest for 25 miles to the end of Biscayne Beach Road where the system will tie into an earthen levee system.

The Bolivar Peninsula dune field system reach is 25 miles in length, of which 10.7 miles are within Coastal Barrier Resource Act (CBRA) zones. The dune field system will have a seaward dune elevation of 12.0' and a landward dune elevation of 14.0'. The dune system is further detailed in the Bolivar Dune System in the Map books attached with the study report (Section 4.0).

Feasibility level design relies heavily on a GCCPRD report dated October 18, 2017. Foundation analyses for Bolivar Peninsula Beach and Dune System used information from soil borings BH-01, BH-02 and CPT soundings CPT-01 through CPT-23 as shown on Figure 3-12. Subsurface conditions along the Bolivar Peninsula Beach and Dune System is presented in Plate 5a of FUGRO/GCCPRD 2017 report (Annex 8).

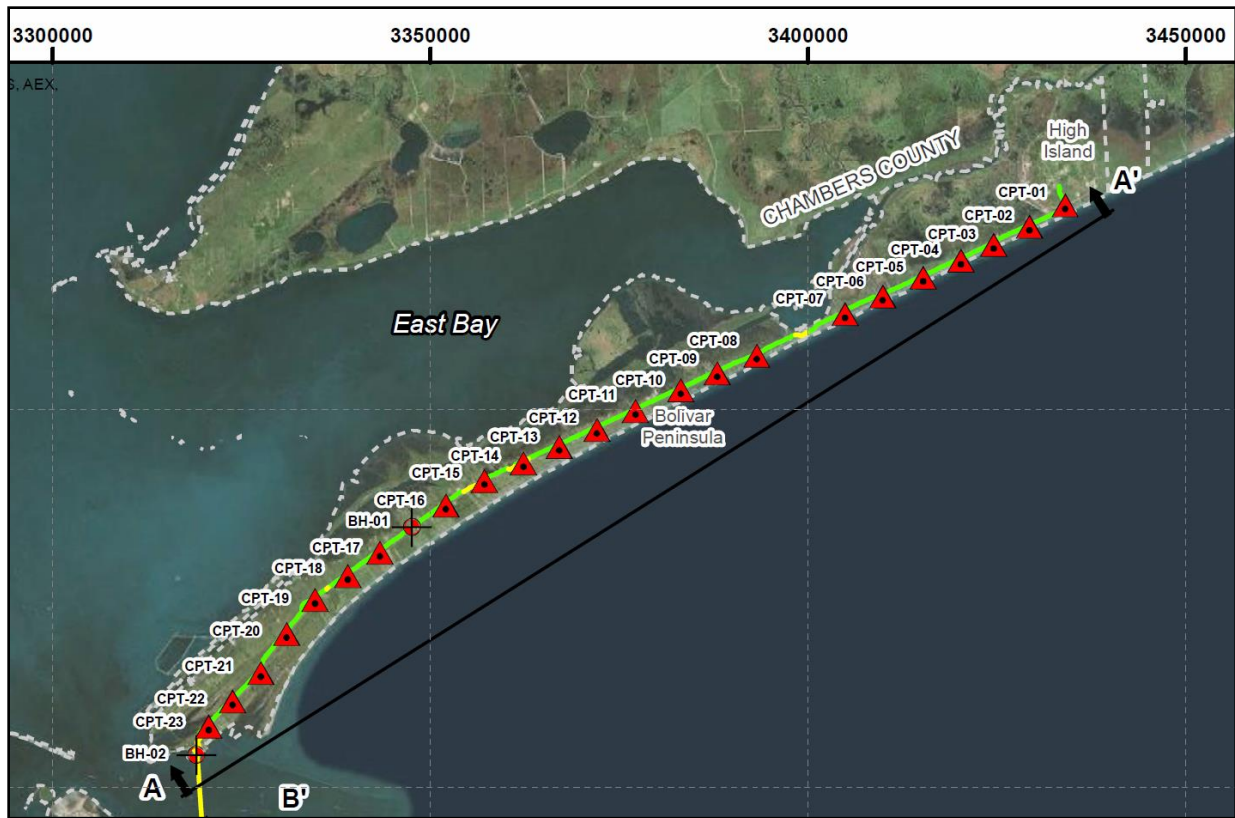

Figure 3-12: Eastern Tie-in and Bolivar Peninsula Reach
(Source: GCCPRD, 2017)

3.4.2 Foundation Conditions – Ecosystem Restoration (ER)

Little to no relevant soil boring information was found for the subsurface information in the vicinity of subject ER measures. Therefore, feasibility-level engineering relies heavily on the General Soil Maps for the ER sites prepared by USDA SCS compiled in 1986 and site topographic maps. ER features include miscellaneous shallow foundation structures including rock breakwater structures, and temporary confinement berms for marsh restoration. Therefore, the potential risk level related to developing geotechnical parameters can be classified as low due to the nature of the shallow foundation system.

3.4.3 Analysis Soil Profiles and Soil Parameters

Soil profiles and representative geotechnical parameters were identified for every reach based on existing data from geotechnical investigations and laboratory testing. Available borings and CPTs were grouped based on proximity and their similarities of strata classifications, configuration, and properties as discussed in the previous section of foundation conditions. The geotechnical analysis of the study involved consideration of the upper- and lower- bound strength values of the subsurface layers to mitigate the risk of change in project foundation cost during the PED phase due to potential change in

geotechnical conditions. The adopted mitigation strategies for the geotechnical analysis are summarized in the following section called Assessment of risk levels associated with the uncertainty of subsurface conditions.

3.4.3.1 Bolivar Peninsula Beach and Dune System

The representative soil parameters for the anticipated levee embankment foundation soils were developed for the global stability analysis of the levee segments proposed as part of the Bolivar Peninsula Beach and Dune System are presented in Table 3-1 as summarized in FUGRO/GCCPRD 2017 report (Annex 9).

Table 3-1: Soil Parameters for Slope Stability Analysis – Bolivar Peninsula Reach

Depth (feet)	Soil Description	Total Unit Weight (pcf)	Short-term (Undrained)		Long-term (Drained)		Rapid Drawdown	
			Cohesion (psf)	Friction Angle (degrees)	Effective Cohesion (psf)	Friction Angle (degrees)	Cohesion (psf)	Friction Angle (degrees)
0 to 5	Sand	115	0	25	0	25	0	25
5 to 15	Soft Clay	105	300	0	50	17	75	12
15 to 60	Soft to Stiff Clay	125	Top: 300 Bottom: 1,000	0	Top: 50 Bottom: 200	Top: 17 Bottom: 21	Top: 75 Bottom: 250	Top: 12 Bottom: 16

pcf = pounds per cubic foot; psf = pounds per square foot

The representative soil parameters for the anticipated levee embankment fill soils were developed for the global stability analysis of the proposed levees along the Bolivar Peninsula reach are presented in Table 3-2 as summarized in FUGRO/GCCPRD 2017 report (Annex 9).

Table 3-2: Soil Parameters for Slope Stability Analysis – Compacted Clay (Fat Clay or Lean Clay) Fill

Depth (feet)	Total Unit Weight (pcf)	Short-term (Undrained)		Long-term (Drained)		Rapid Drawdown	
		Cohesion (psf)	Friction Angle (degrees)	Effective Cohesion (psf)	Friction Angle (degrees)	Cohesion (psf)	Friction Angle (degrees)
Varies	115	600	0	50	20	170	15

The representative soil parameters for the anticipated levee embankment soils were developed for the settlement analysis of the proposed levees along the Bolivar Peninsula reach are presented in Table 3-3 as summarized in FUGRO/GCCPRD 2017 report (Annex 9). Table 3-3 does not include settlement parameters for the fill soils as the anticipated settlement within the embankment fill would be negligible.

Table 3-3: Soil Parameters for Settlement Analysis – Bolivar Peninsula Reach

Depth (feet)	Soil Description	Total Unit Weight (pcf)	Compressibility Parameters			
			CR ¹	RR ²	OCR ³	Cv ⁴ (feet/year)

0 to 5	Loose Sand	115	E ⁵ : 300 ksf	--	--	300
5 to 15	Soft Clay	105	0.15	0.03	N/A	7
15 to 60	Soft to Stiff Clay	125	0.20	0.02	N/A	7

¹ Strained-based compression index.

² Strained-based re-compression index.

³ Over-consolidation ratio.

⁴ Coefficient of Consolidation

⁵ Modulus of Elasticity

3.4.3.2 Galveston Harbor Entrance Channel Crossing

The representative soil parameters for Galveston Harbor Entrance Channel Crossing were developed based on recent soil borings (BH-02 and BH-03) as shown on Figure 3-11 and presented in the GCCPRD report dated October 18, 2017 (Annex 8). The summary of representative soil parameters used for the preliminary design of the Galveston Harbor Entrance Channel Crossing deep foundation system is presented in Table 3-4.

Table 3-4: Soil Parameters for Foundation Analysis – Galveston Harbor Entrance Channel Crossing Reach

Reference Boring	Depth (feet)	Soil Description	Total Unit Weight (pcf)	Shear Strength Parameters		Laboratory Data			Raw SPT Blow count
				Undrained Shear Strength (psf)	Friction Angle (degrees)	Liquid Limit (%)	Plasticity Index (%)	Water Content (%)	
BH-02	0 to 47	Loose Sand/Soft Clay	110	N/A	N/A	21 to 33	2 to 15	25	2 to 24
	47 to 78	Medium dense Sand	120		32				13 to 21
	73 to 78	Loose Sand	120		30				9
	78 to 93	Firm to very stiff Clay	120	550 to 2,000		57	43	13	
	93 to 108	Medium dense to dense Sand	120		32				30 to 35
	108 to 400	Stiff to very stiff Clay	120	1,000 to 2,000		24 to 84	9 to 64	20 to 34	
BH-03	0 to 60	Loose to medium dense Sand /Soft Clay	110	N/A	N/A				
	60 to 120	Firm to very stiff Clay	120	500 to 1,900		60 to 95	44 to 74	28 to 56	
	120 to 178	Medium dense to very dense Sand	120		32				28 to more than 50
	178 to 198	Loose to medium dense Sand	120		30				10 to 28

Reference Boring	Depth (feet)	Soil Description	Total Unit Weight (pcf)	Shear Strength Parameters			Laboratory Data		Raw SPT Blow count
				Undrained Shear Strength (psf)	Friction Angle (degrees)	Liquid Limit (%)	Plasticity Index (%)	Water Content (%)	
	198 to 200	Stiff to very stiff Clay	120	1,200 to 2,000		30 to 87	17 to 68	19 to 37	

3.4.3.3 Galveston Barrier and West Galveston Island Beach and Dune System

The representative soil parameters developed for the global stability analysis of levee segments proposed as part of Galveston Barrier and West Galveston Island Beach and Dune System are presented in

Table 3-5 as summarized in FUGRO/GCCPRD 2017 report (Annex 9).

Table 3-5: Soil Parameters for Slope Stability Analysis – Galveston Ring Levee/ Floodwall Reach and West Galveston Island Reach

Depth (feet)	Soil Description	Total Unit Weight (pcf)	Short-term (Undrained)		Long-term (Drained)		Rapid Drawdown	
			Cohesion (psf)	Friction Angle (degrees)	Effective Cohesion (psf)	Friction Angle (degrees)	Cohesion (psf)	Friction Angle (degrees)
0 to 8	Sand	115	0	25	0	25	0	25
8 to 16	Soft Clay	105	300	0	50	17	75	12
16 to 20	Sand	115	0	30	0	30	0	30
20 to 45	Soft to Firm Clay	105	Top: 300 Bottom: 800	0	Top: 50 Bottom: 200	Top: 17 Bottom: 21	Top: 75 Bottom: 250	Top: 12 Bottom: 16
45 to 60	Stiff Clay	125	1,200	0	250	21	300	16

The representative soil parameters assumed for recommended fill materials (compacted fat or lean clays) for proposed levee construction and considered for global stability analysis along the Galveston Ring Levee/Floodwall Reach and West Galveston Island Reach are presented in Table 3-6 as summarized in FUGRO/GCCPRD 2017 report (Annex 9).

Table 3-6: Soil Parameters for Slope Stability Analysis – Compacted Clay (Fat Clay or Lean Clay) Fill

Depth (feet)	Total Unit Weight (pcf)	Short-term (Undrained)		Long-term (Drained)		Rapid Drawdown	
		Cohesion (psf)	Friction Angle (degrees)	Effective Cohesion (psf)	Friction Angle (degrees)	Cohesion (psf)	Friction Angle (degrees)
Varies	115	600	0	50	20	170	15

The representative soil parameters developed for the settlement analysis of supporting soil due to proposed levee embankment along the Galveston Ring Levee/Floodwall Reach and West Galveston Island Reach are presented in

Table 3-7 as summarized in FUGRO/GCCPRD 2017 report (Annex 9).

Table 3-7 does not include settlement parameters for the fill soils as the anticipated settlement within the embankment fill would be negligible.

Table 3-7: Soil Parameters for Settlement Analysis – Galveston Ring Levee/
Floodwall Reach and West Galveston Island Reach

Depth (feet)	Soil Description	Total Unit Weight (pcf)	Compressibility Parameters			
			CR ¹	RR ²	OCR ³	C _v ⁴ (feet/year)
0 to 8	Loose Sand	115	E ⁵ : 300 ksf	--	--	300
8 to 16	Soft Clay	105	0.15	0.03	N/A	7
16 to 20	Medium Dense Sand	115	E ⁵ : 450 ksf	--	--	300
20 to 45	Soft to Firm Clay	105	0.20	0.02	N/A	7
45 to 60	Stiff Clay	125	0.20	0.02	N/A	7

¹ Strained-based compression index.

² Strained-based re-compression index.

³ Over-consolidation ratio.

⁴ Coefficient of Consolidation

⁵ Modulus of Elasticity

3.4.4 Feasibility Level Geotechnical Design Analysis Results and Assumptions for CSRMs Features

The current feasibility level geotechnical design adopts appropriate risk mitigation strategies, including reasonable engineering assumptions and considerations to meet the subject study requirements. Tables 3-8, 3-9, and 3-10 present the summary of the CSRMs features considered in the preliminary design of the project structures.

Table 3-8: Summary - Feasibility Level Geotechnical Design Analysis Results and Assumptions for CSRM Features: Surge Barrier

Proposed Structural Elements	Features Dimensions:	Considered Foundation Elements	Risk Level Associated with Uncertainty of Subsurface Conditions
Combi-wall at Bolivar	Total Length Along Alignment = 5,300 feet, Structure Top EL. 21.5 feet Mud Line EL. 5 feet	Deep Foundation System 36- inch dia. Steel Pipe Piles (1-inch wall thickness) (Battered, 1H:5V) 66- inch dia. Precast- Pre-Stressed Pipe Piles (9-inch wall thickness). Riprap Scour Protection.	Medium Level
Vertical Lift Gate, sill EL. -20.0 feet,	Total Length Along Alignment = 2,400 feet Number of Structures (N)=8 Individual Structure Width = 300 feet, Tower Top EL. = 121.5 feet Gate Top EL. (Closed Position feet) = 21.5 feet Sill EL. = -20 feet	Deep Foundation System 24- inch dia. Steel Pipe Piles (3/4-inch wall thickness), cutoff EL. -40 feet. Temporary Cofferdam PS31 Steel Sheet Pile (Cellular Structure) Riprap Scour Protection	Medium Level
Deep Vertical Lift Gate, sill EL. -40.0 feet,	Total Length Along Alignment = 2100 feet, Number of Structures (N) = 7 Individual Structure Width = 300 feet, Tower Top EL. = 121.5 feet Gate Top EL. (Closed Position) = 21.5 feet Sill EL. = -40 feet	Deep Foundation System 24- inch dia. Steel Pipe Piles (3/4-inch wall thickness), cutoff EL. -60 feet Temporary Cofferdam PS31 Steel Sheet Pile (Cellular Structure) Riprap Scour Protection	Medium Level
125 feet Sector Gate at Bolivar, Sill EL. -40.0 feet	Number of Structures (N) = 2 Individual Structure Width = 125 feet, Height = 61.5 feet, Gate Top EL. = 21 feet Sill EL. = -40 feet	Deep Foundation System 24- inch dia. Steel Pipe Piles (1/2-inch wall thickness), cutoff EL. -52 feet Temporary Cofferdam PZC-13 Steel Sheet Pile (Cellular Structure) Riprap Scour Protection	Medium Level
650 feet Navigation Gate, Sill EL. -60.0 feet, and Artificial Islands to secure the Floating Sector Gates	Number of Structures (N) = 2 Individual Structure Width = 650 feet, Height = 81.5 feet, Structure Top EL. = 21 Sill EL. = -60	Deep Foundation System 48- inch dia. Steel Pipe Piles (1-inch wall thickness), cutoff EL. -52 feet Artificial Islands Steel Sheet Pile Type PS-31, ASTM A 572-grade 60 Temporary Cofferdam PZC-13 Steel Sheet Pile (Cellular Structure) Riprap Scour Protection	Medium Level
Shallow Water Environmental Gates (SWEG)	Number of Structures (N) = 16 Individual Structure Width = 112.5 feet, Height = 26.5 feet, Structure Top EL. = 21.5 Sill EL. = -5	Deep Foundation System 24- inch dia. Steel Pipe Piles (3/4-inch wall thickness), cutoff EL. -10 feet,	Medium Level

Table 3-9: Summary - Feasibility Level Geotechnical Design Analysis Results and Assumptions for CSRМ Features: Beach and Dune System

Proposed Structural Elements	Features Dimensions:	Considered Foundation Elements	Risk Level Associated with Uncertainty of Subsurface Conditions
Bolivar Peninsula Beach and Dune System.	Total Length Along Alignment = 25.1 miles,	Beach Quality Sand, Dune Slope 1V:5H, Berm Slope 1V:100H Dune field Dune 1 (Crest EL. 14 feet, Toe EL 6 feet), Dune 2 (Crest Ele. 12 feet, Toe Ele 4 feet)	Low Level
Galveston Island Beach and Dune System.	Total Length Along Alignment = 18.4 miles,	Beach Quality Sand, Dune Slope 1V:5H, Berm Slope 1V:100H Dune field Dune 1 (Crest Ele. 14 feet, Toe Ele 6 feet), Dune 2 (Crest Ele. 12 feet, Toe Ele 4 feet)	Low Level
South Padre Island Beach and Dune Nourishment.	Total Length Along Alignment = 2.9 miles,	Beach Quality Sand, Dune Slope 1V:5H, Berm Slope 1V:100H Dune field Dune 1 (Crest EL. 14 feet, Toe EL. 6 feet), Dune 2 (Crest EL. 12 feet, Toe EL. 4 feet)	Low Level

Table 3-10: Summary - Feasibility Level Geotechnical Design Analysis Results and Assumptions for CSRМ Features: Galveston Ring Barrier System (GRBS)

Proposed Structural Elements	Features Dimensions:	Considered Foundation Elements	Risk Level Associated with Uncertainty of Subsurface Conditions
125 feet Sector Gate at Offatts,	Individual Structure Width = 125 feet Height = 28.5 feet Gate Top EL. = 13.5 feet Sill EL. = -15 feet	Deep Foundation System 24- inch dia. Steel Pipe Piles (1/2-inch wall thickness), cutoff EL. -23 feet Temporary Cofferdam PZC-13 Steel Sheet Pile (Cellular Structure) Riprap Scour Protection	Medium Level
Shallow Water Environmental Gates (SWEG)	Individual Structure Width = 112.5 feet Structure Top EL. = 21.5 feet Sill EL. = -5 feet	Deep Foundation System 24- inch dia. Steel Pipe Piles (3/4-inch wall thickness), cutoff EL. -10 feet	Medium Level
Combi-wall at Offatts,	Structure Top EL. 21.5 feet Sill EL: -4 feet	Deep Foundation System 36- inch dia. Steel Pipe Piles (1-inch wall thickness) (Battered 1H:5V.) 66- inch dia. Precast- Pre-Stressed Pipe Piles (9-inch wall thickness). Riprap Scour Protection	Medium Level
Pump Stations	N/A	Deep Foundation System 12- to 36- inch Steel Pipe Piles (Vertical and Battered)	Medium Level

The typical section of the Beach and Dune System considered for the project is shown on Figure 3-13. A beach quality sand is considered as the suitable construction material for the beach and dune system. The project Beach and Dune System adopts a dune field feature with a side slope gradient of 5H: 1V, as shown on Figure 3-13.

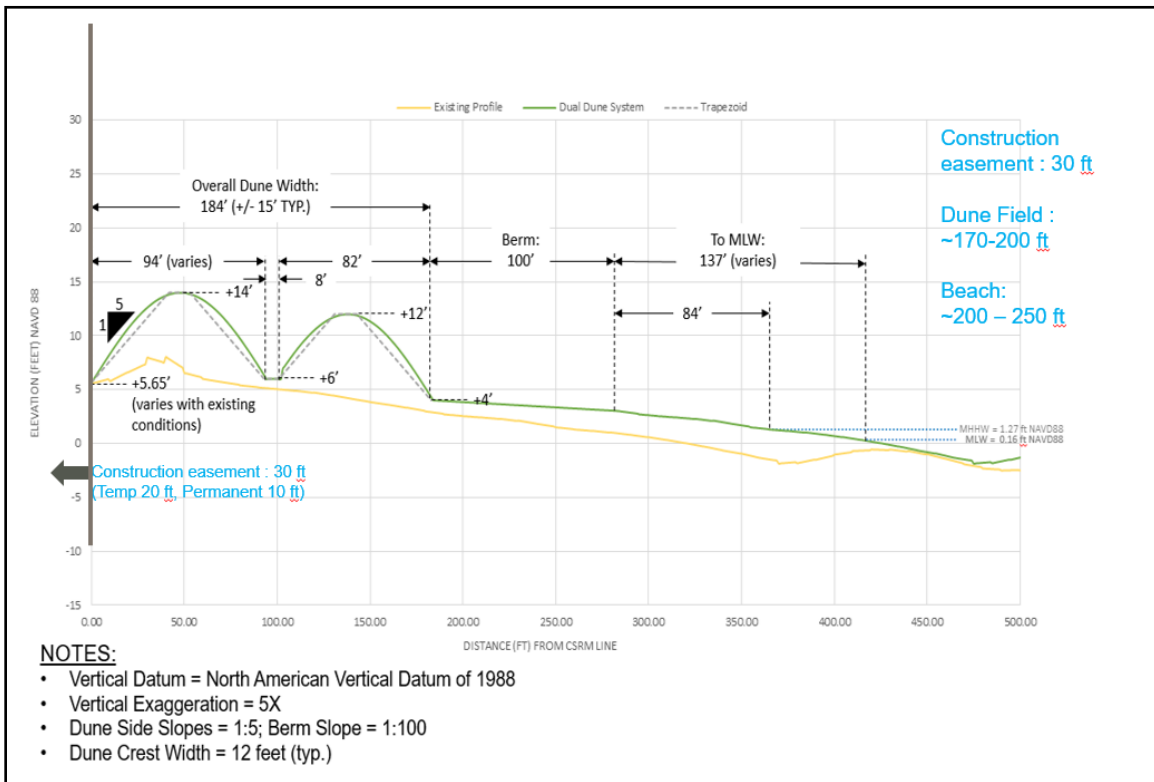

Figure 3-13: Typical Beach Dune System Section

3.4.5 Feasibility Level Geotechnical Design Analysis Results and Assumptions for Channel Widening and Anchorage Area Improvement

Construction of the surge barrier gates across the Galveston Harbor Entrance Channel will require a temporary bypass for navigation, channel widening, and anchorage area improvements (Refer Section 4 – Civil Design section for improvement details).

The potential Dredged Material classification was evaluated based on available geotechnical data and presented, as shown on Figure 3-14.

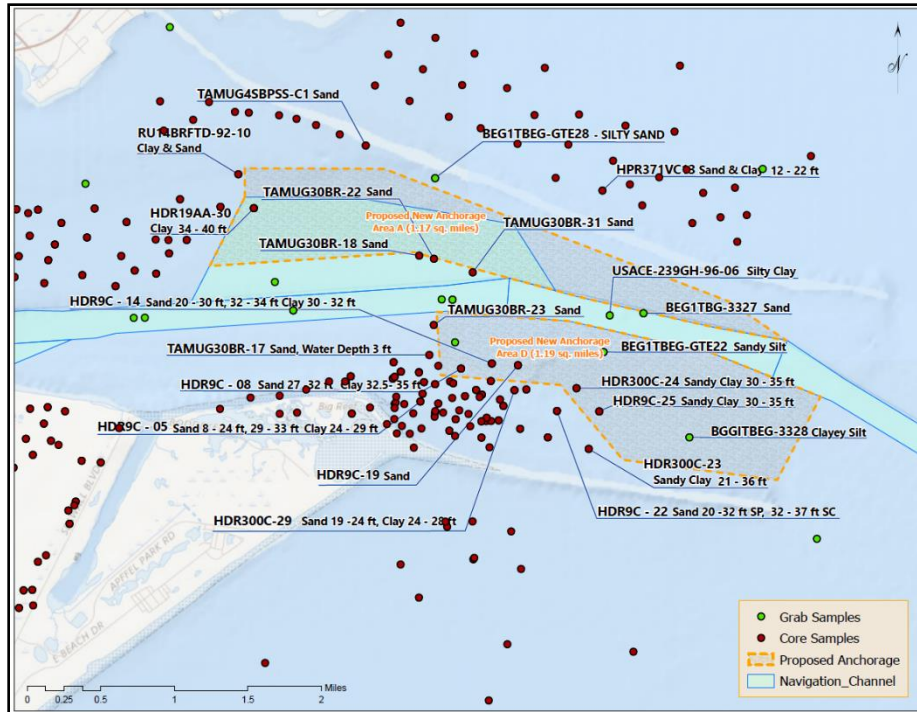

Figure 3-14: Proposed Galveston Harbor Entrance Channel and Anchorage Area Improvements

(Source: <https://gisweb.glo.texas.gov/txsed/index.html>)

3.4.6 Feasibility Level Geotechnical Design Analysis Results and Assumptions for Ecosystem Restoration Measures

3.4.6.1 Breakwaters

Concept design for offset rock breakwaters (constructed in shallow water away from the banks with breaks as needed for fishery access) are used for estimates. They have a design height for 20–25-year life, including relative sea level rise (RSLR) or barge wake run-up (whichever is higher). A total maximum base width of 46 feet, height of 10 feet, crest width of 3 feet, toe bench of 3 feet, side slopes of 2H:1V were assumed as shown below for the typical breakwater section (Figure 3-15). In general, placing of suitable dredged material to raise the existing grade up to the design grade of -3-foot elevation is considered for the foundation bottom preparation at elevations below MSL. Breakwaters will be raised as needed to account for RSLR and maintain the effectiveness of structures through the POA. Existing placement area levees are being maintained over a 50-year POA and that breakwaters are only needed in shorelines areas without placement area levees. Excavation may be required to install breakwater toe protection, if so, the material may be used to fill behind breakwaters or fill access channels. 1-foot thick blanket Stone (1/4 to 4 inches) above the geotextile (Tencate Mirafi 1160 N) base which is considered for the breakwater. A 3-foot-long geotextile in anchor trench at both toes were

assumed as shown below for the anchoring of the geotextile material within the breakwater section. Class C type riprap with an average unit weight of 1.5 tons/cubic yard (cy) was considered for the study.

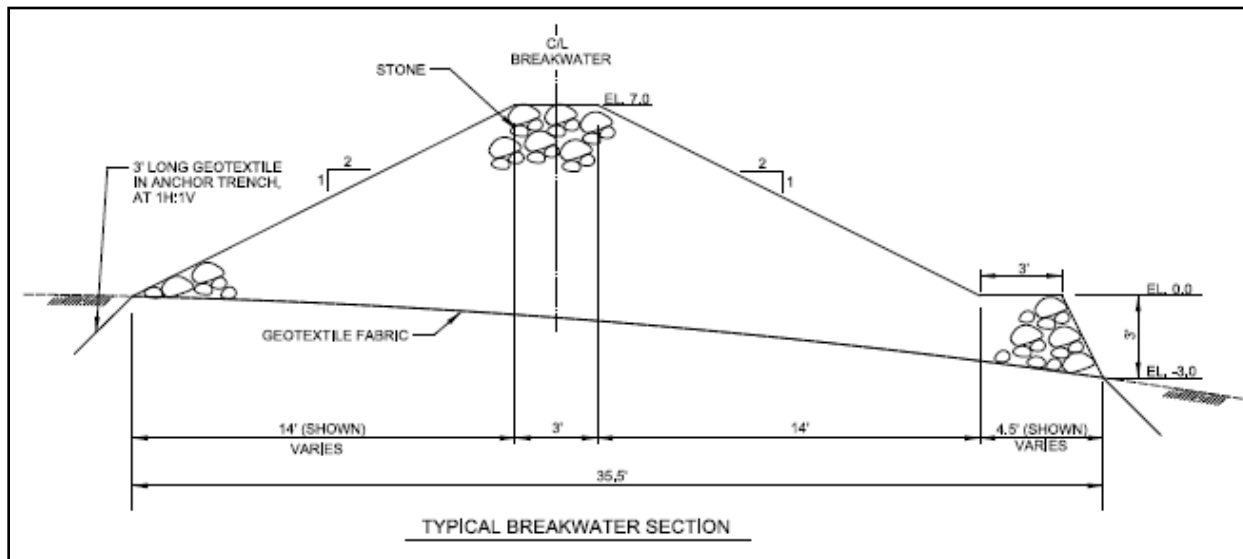

Figure 3-15: Typical Proposed Breakwater Section

The final breakwater structure height will vary with foundation soil conditions, by considering the foundation settlement (immediate and long-term) during and after the construction of breakwater.

3.4.6.2 Marsh Restoration (Initial Construction)

Marsh restoration requires several steps over an 8-year period. First, construct temporary containment levees and drainage structures. Place dredge material to nourish the existing marsh in the containment area. Next develop sinuous circulation channels and ponds using marsh buggies to compress the soil. Next, plant smooth cordgrass (*Spartina alterniflora*) and other appropriate marsh plants on 5-foot centers. The next year, replant 50 percent of the plants, as needed. After the seagrass is growing, remove or extensively degrade the containment levees to allow broad tidal access.

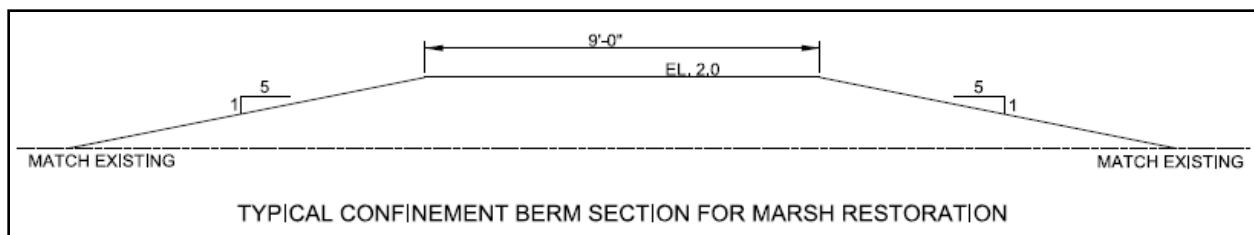

Figure 3-16: Typical Proposed Temporary Confinement Berm Section for Marsh Restoration

Existing ground elevation was assumed as –1.0 foot (NAVD 88) and the dredged material to be placed up to an elevation of 1.2 feet (NAVD 88) to create the marsh. Final elevations to be determined during future planning and design phases with resource agency input.

3.4.6.3 Island Restoration

Borrow material would be sourced from the dedicated dredging of the GIWW (shoaled and/or virgin sediment) to restore the island to approximate historical condition.

The material would be semi-confined with containment levees along the GIWW and ends, allowing the material to form a natural slope into the bay, creating elevations suitable for marsh growth and unconsolidated shore for wading birds and submerged aquatic vegetation (SAV) habitat.

The proposed island section's crown elevation will be at least 3 feet above the high water in the year 2085, and the island side slopes will be 5H:1V.

Design of island would be finalized in the future planning and design phases, with care taken to avoid existing SAV and oyster reef to the greatest degree practicable. Silt curtains would be deployed during construction to prevent movement of sediments into nearby SAV beds and oyster reef habitats.

3.5 BORROW SOURCES

Commercial borrow sources were assumed for levee construction and potential sources are identified on Figure 3-17. Sources were identified throughout Galveston, Harris, Brazoria, and Chambers Counties. The project estimate assumes that the material would be hauled to the site features via major highways. The commercial sites with suitable material for levee construction identified as sources are currently active. However, there is potential that they may no longer be available at the start of construction. A Material Source Investigation Study prepared by Mott MacDonald was conducted to identify potential borrow sources for the Coastal Storm Risk (CSR) and Ecosystem Restoration (ER) measures along with a preliminary costing analysis to include transportation costs which lead to the assumptions carried forward for project feature borrow material (Annex 10). The suitability of the material for levee construction could require structural or chemical measures to assure stability of the levee. Additionally, the existence of hazardous material or chemicals within the areas is unknown.

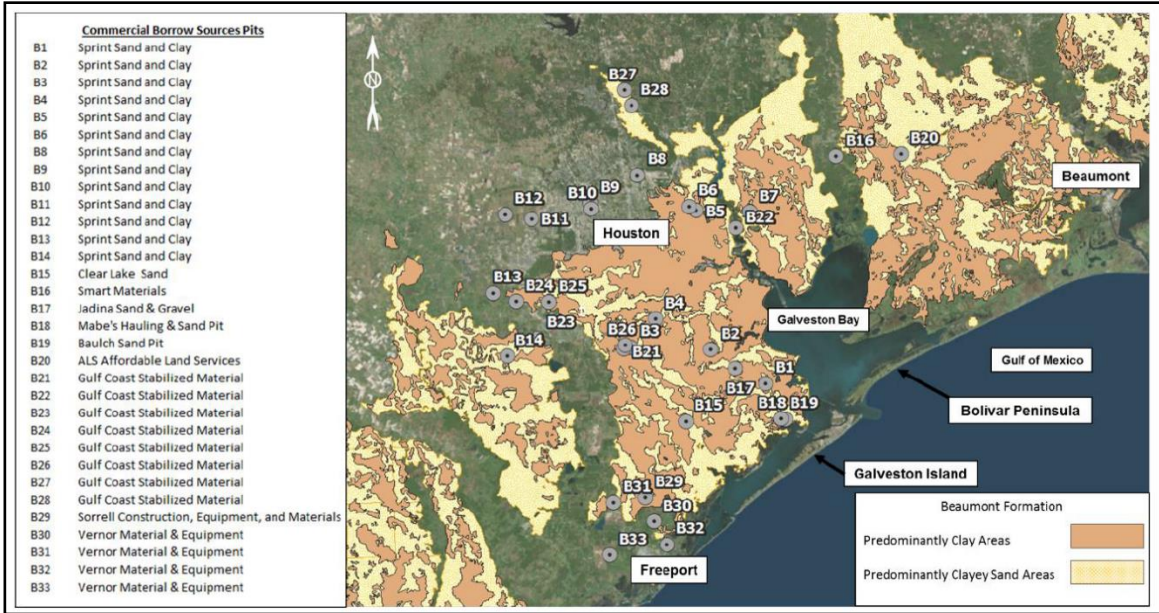

Figure 3-17: CSRM - Commercial Borrow Sources

3.6 RECOMMENDATIONS FOR GEOTECHNICAL DESIGNERS DURING PED PHASE

This study recommends a comprehensive level of geotechnical investigations, a pile drivability study, and pile load testing during the PED as mandatory project requirements for all the deep foundation system proposed for the CSRM features. The recommended comprehensive geotechnical investigation shall meet the requirements for detail level geotechnical analysis of the proposed CSRM, ER features, channel widening and anchorage area improvement. The pile drivability study shall identify appropriate pile types, energy rate for hammers and related pile driving equipment types. Pile drivability study shall consider necessary measures for minimizing the vibration levels during pile installation as discussed in the Risk and Uncertainty Section of this report.

4.0 CIVIL DESIGN AND FOOTPRINT

This section presents the general civil design considerations and footprints of CSRM and ER features for the Recommended Plan.

4.1 COASTAL STORM RISK MANAGEMENT FEATURES

The CSRM features along the Recommended Plan alignment consist of beach and dune, levee, floodwall, combi-wall, seawall, roadway gates, railroad gates, navigation gates, vertical and sluice gates to serve navigation or for tidal exchange, drainage closure structures, and pump stations.

4.1.1 Bolivar Peninsula and West Galveston Beach and Dune System

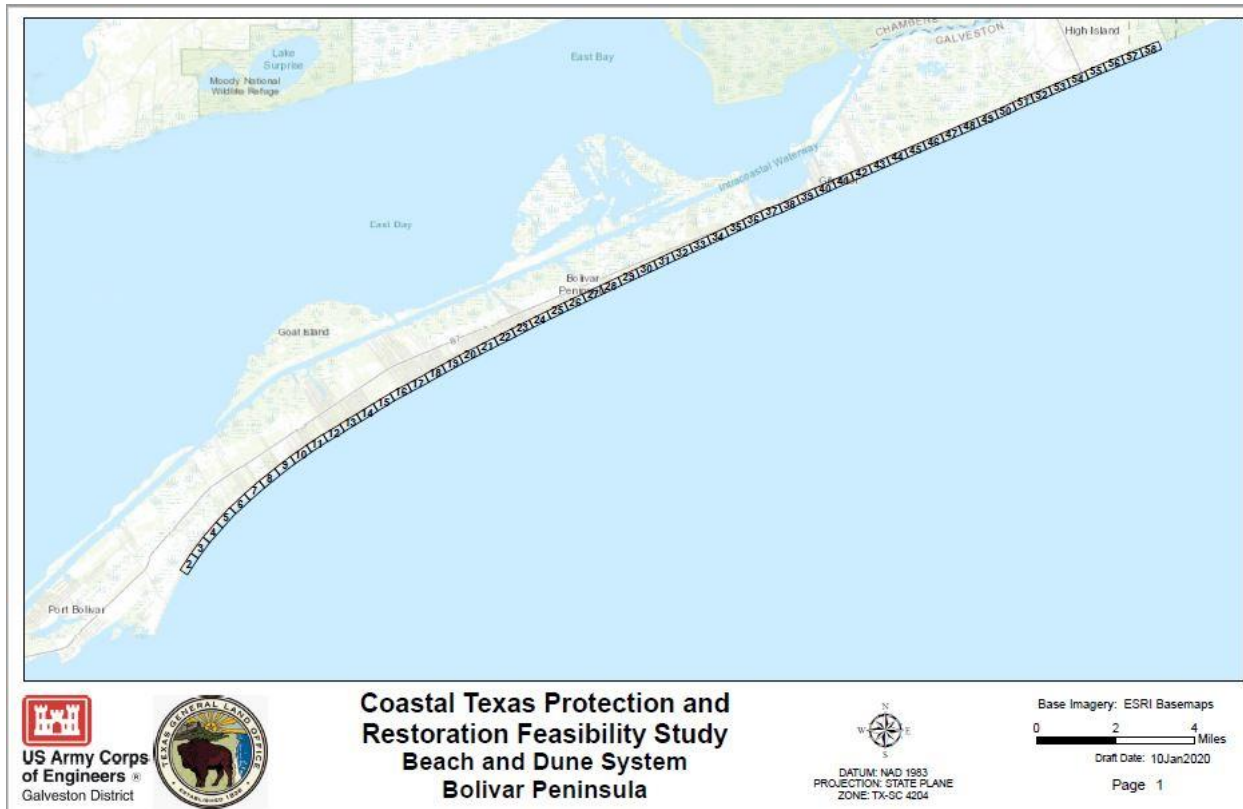

Figure 4-1: Bolivar Peninsula Beach and Dune System

The Bolivar Peninsula beach and dune system reach is 25.1 miles in length. The dune field will have a seaward elevation of 12.0 ft and a landward elevation of 14.0 ft NAVD88. The beach and dune system is further detailed in the Bolivar Dune System Mapbook (Annex 11). Refer to Plate 1 (Annex 12) for a Typical Beach and Dune Section.

The Bolivar Peninsula beach and dune system starts approximately 2.0 miles east of State Highway 87 and continues southwest for 25.1 miles to the end of Biscayne Beach Road where the system will tie-into an earthen levee system adjacent to Fort Travis.

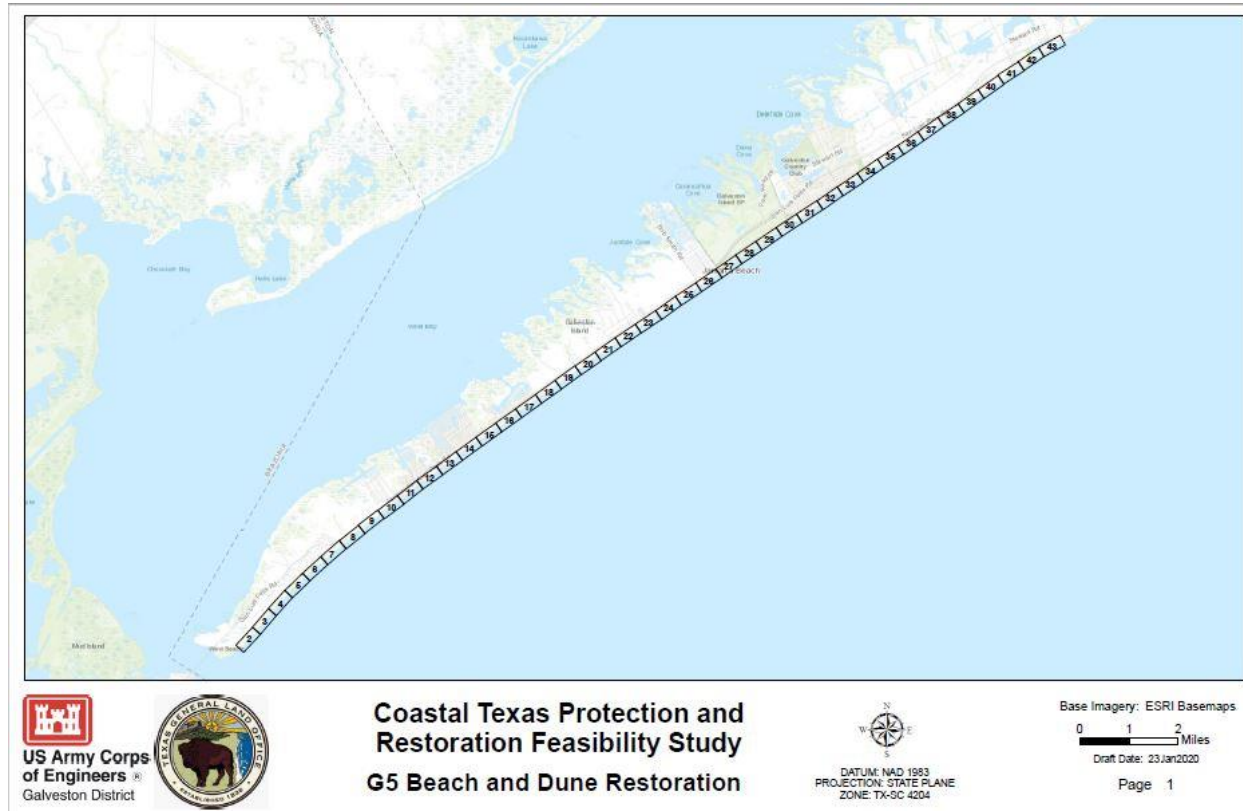

Figure 4-2: West Galveston Beach and Dune System

The West Galveston beach and dune system is 18.4 miles long. The dune field system will have a seaward dune elevation of 12.0 ft and a landward dune elevation of 14.0 ft NAVD 88. The beach and dune system is further detailed in the Galveston Beach and Dune System Mapbook (Annex 13). Refer to Plate 1 (Annex 12) for a Typical Beach and Dune Section.

The West Galveston beach and dune system would start at the end of the existing Galveston seawall and continue westerly for 18.4 miles ending at San Luis Pass. Beach and dune material sourcing and re-nourishment is discussed in Chapter 5.0. The design guidance for the beach and dune vegetation, sand fencing, walkovers and access is based on the, Dune Protection and Improvement Manual for the Texas Gulf Coast (XX 5th Edition).

4.1.2 **Dune Vegetation**

The dune field system would be planted with grass species typically utilized along the Texas coast for dune construction. Plant grass species include bitter panicum (*Panicum amarum*), sea oats (*Uniola paniculata*), and marshhay cordgrass (*Spartina patens*). Dune plants would either be obtained from commercial sources or transplanted from natural stands along the coast. Plant species that are not available commercially would be obtained from natural stands, which would increase the survivability of the species. Cost estimates were developed assuming that plants species would be obtained within a 7-mile radius of the construction site. If suitable stands cannot be found on state owned property, harvesting from neighboring private property could be accomplished with agreement from the property owner. A permit from the county commissioners court or from a city may be required if the harvesting or planting site is seaward of an existing dune protection line in accordance with state Beach Access and Dune Protection Laws. The optimum time for transplanting and establishing vegetation on Bolivar and West Galveston is during the months of February, March, or April. Planting cost estimates assumed that 1,000 plants would stabilize a 50x100-foot strip within a year and include watering, mulch, fertilization, and replanting due to lost.

4.1.3 **Sand Fencing**

Standard slatted wood sand fencing would be installed at appropriate locations to allow for the sustainability of the dune system. A height of four feet, measured from the ground surface after installation, is recommended for dune-building structures. In areas where sand conditions are poor for dune building, a height of two feet would be utilized. The fencing would be supported with treated pine posts at 10-foot intervals. Minimum practical length for posts is 6.5 feet; a length of 7 to 8 feet is optimum. Wooden posts be no larger than three inches in diameter. The fencing would be secured to each post with four ties of galvanized wire that is not smaller than 12 gauge. The fencing material would be weaving between the posts so that every other post has fencing on the seaward side. Sand fencing should be placed in non-continuous, diagonal segments—at least 35 degrees to the shoreline—so as not to adversely affect nesting sea turtles. A typical sand fencing installation detail is shown in Figure 4-3.

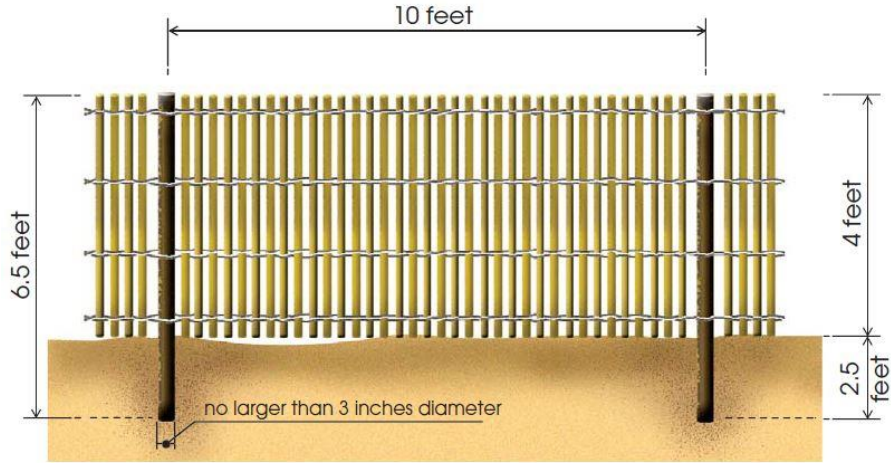

Figure 4-3: Typical Sand Fencing Installation Detail

4.1.4 Dune Walkovers

The dune walkovers would be constructed of treated lumber and galvanized hardware. Typical structural design for the walkovers are shown in Figure 4-4 and Figure 4-5.

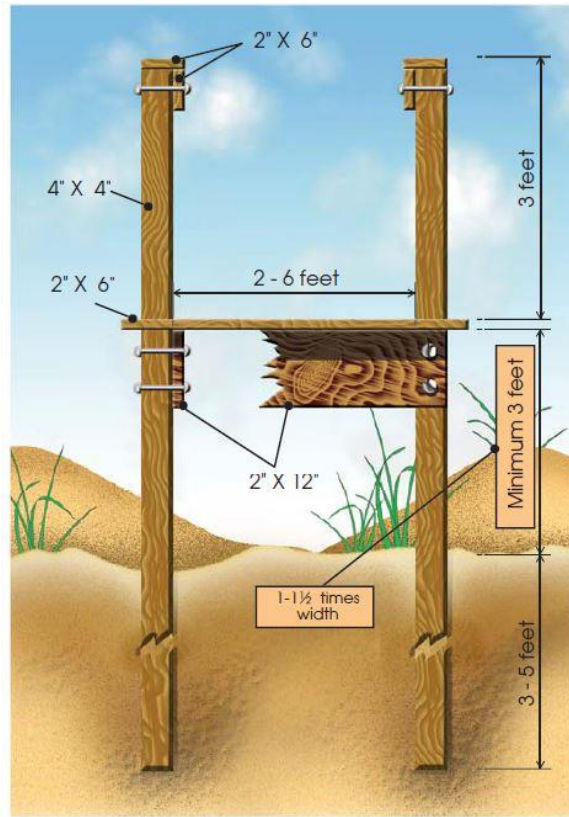

Figure 4-4: Typical Walkover Section

Pedestrian traffic volume will be investigated during PED to determine an appropriate walkover width for the location. The figures illustrate what have previously been constructed for accessible dune walkovers. During PED the PDT will work with local, state, and federal ADA/ABA boards to provide dune walkovers designs that improve accessibility for the handicapped. The structure height would be at least one to one and a half times its width (3' minimum) to allow sunlight to reach vegetation underneath the structure. The maximum slope for ADA is 1V:12H in inches and for every 30 inches in drop vertically, a level platform is required before proceeding at the maximum slope.



Figure 4-5: Typical Walkover Ramp

4.1.5 **Vehicle Access Ramps**

Proposed vehicle access ramp locations are shown on the mapbooks for both Bolivar and West Galveston (Annex 11, 13). The ramps would be oriented at an angle to the prevailing wind direction to reduce water and wind from being channeled along the ramp eroding the dunes at the side of the road cuts as shown below (Figure 4-6).

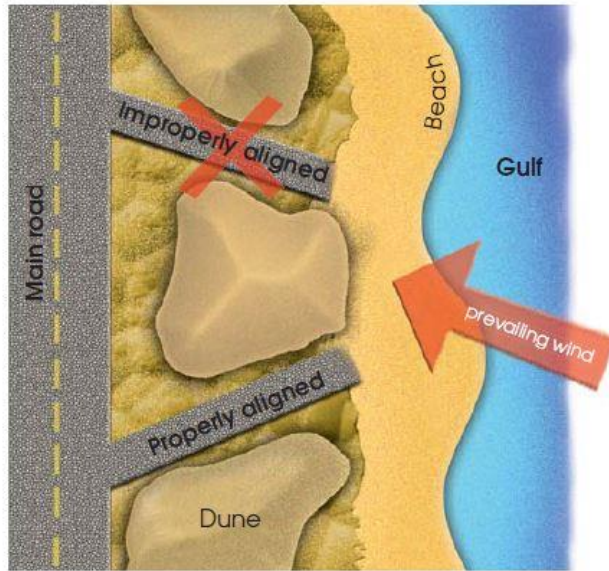

Figure 4-6: Alignment of an Access Ramp

The access ramp would ramp to the elevation of the landward dune and would then ramp down to a break in the seaward dune. This approach would minimize the ramp length to crossing the two-dune system. Ramps would be 12-foot in width with a minimum ramp slope of 6% slope, constructed of sand fill, 8" of gravel base material stabilized with the utilization of a geogrid. The ramp concept is shown on Plate 3 (Annex 12). User surveys will be conducted during the design phase to identify heavy traffic use areas to properly locate access ramps.

BOLIVAR ROAD CROSSING



Figure 4-7: Houston Ship Channel Navigation Gate and Tie-In Structures

The crossing starts on Bolivar Peninsula at the end of Biscayne Beach Road with 3.03 miles of earthen levee, as shown in Figure 4-7, and proceeds northwesterly to State Highway 87, where the levee turns south westerly to near the intersection of Keystone and 23rd Streets. The levee will consist of a 1V:3H slope on the protected side and a 1V:6H slope on the unprotected side. The unprotected side of the levee will be armored with stone protection and the remainder of the levee will be turfed. A Typical section of levee is shown on Plate 2 (Annex 12).

The barrier continues southwest with combi-wall for 5,000 feet reaching the start of the gate system across the Galveston Entrance Channel. Details for the combi-wall are discussed in Section 7.0. The crossing continues south with a series of gates as detailed below.

The 2.08 mile gate system (Figure 4-7) crossing Galveston Harbor Entrance Channel consists of 16 shallow water environmental gates at elevation -5.0, 5 vertical lift gate at elevation -20.0, 3 vertical lift gates at elevation -40.0, 125' sector gate at sill elevation of -40.0 for recreational traffic, 2 vertical lift gates at a sill elevation of -40.0, 2-650' floating sector gate at a sill elevation of -60.0. The sill elevation across the ship channel will allow for any future deepening of the Galveston Harbor Entrance Channel, which is currently maintained at a depth of -48 feet MLLW. The sector gates across the ship channel are anchored and housed in man-made "islands" on either side of the Entrance Channel. The channel crossing continues with a 125' sector gate at a sill elevation of -40.0' for recreational traffic, 2 vertical lift gates at a sill elevation of -40.0, and 3 vertical lift gates at a sill elevation of -20.0. The gate system then ties into the end of the existing seawall at the San Jacinto Placement Area on Galveston Island. The top elevation for the crossing is 21.5 feet NAVD 88.

A post TSP ship simulation study (Annex 14) and gate design workshop (Annex 15) was conducted which resulted in the shifting of the gate alignment 300 feet to the east to allow for easy ship maneuvering into the Galveston Harbor Channel. The post TSP gate workshop resulted in changing the gate across the Entrance Channel from a single sector gate to a two-sector gate configuration, and the addition of shallow water environmental gates in the shallow areas to maintain flow and larvae transport.

4.2.1 **Channel Widening**

Construction of the crossing across the Galveston Harbor Entrance Channel will be widened to accommodate the inbound channel and sector gate. The construction of the inbound channel will occur prior to the construction of the sector gate across the existing Entrance Channel in order to minimize impacts to existing channel traffic. The widening of the channel will be north of the existing channel toe, through existing anchorage areas and will be maintained at 800-foot toe to toe wide and depth of – 48 MLLW, which is consistent with the existing channel authorized depths. Figure 4-8 shows the existing Galveston Harbor Entrance Channel, including anchorage areas as well as the proposed Galveston Harbor Entrance Channel Crossing, and new channel. Coordination with industry and the Coast Guard will continue during the design phase in include an additional ship simulation to further investigate potential velocity impacts to navigation. A plan view and typical sections of the channel are show on Plate 4 and 5 (Annex 12).

4.2.2 **Aids to Navigation**

Due to the extension of the existing Galveston Entrance Channel toe to the east to accommodate an inbound lane through the sector gate existing aids to navigation will need to be relocated and additional aids provided due to extension. New aids will be required for the recreational sector gate structures that comprise the crossing. Existing and/or new aids to navigation aids would be the can or conical type. Further coordination with the Coast Guard will be conducted during the detailed design phase.

4.2.3 **Anchorage Area Impacts**

The gate crossing the Galveston Entrance Channel will impact existing anchorages A, B and C as shown in Figure 4-8. The crossing results in Area B being unusable due to the crossing and construction of the sector gate island. Areas A, B, and C are impacted due to the construction of an additional channel lane to the east, extension of the existing channel toe to the east to allow for the construction of an inbound channel for ship traffic and two sector gate system across the entrance channel. The PDT coordinated with industry to address the impacts and present proposed anchorage areas to mitigate the impacts to the existing anchorage areas. Figure 4-9 identifies an area proposed by the industry. However, because of the amount of dredging required, and the relocation of a 24” pipeline, the local sponsor and the District carried forward the New Anchorage Area A which is an expansion of the existing area and Anchorage Area D (Figure 4-10). Due to the cost the anchorage areas shown in Figure 4-10, the proposed new anchorage area A and D were carried forward. A Memorandum of Record (MFR)

between the Galveston District, GLO and Industry has been prepared which documents the communication and resolution on the anchorage issues (Annex 16)

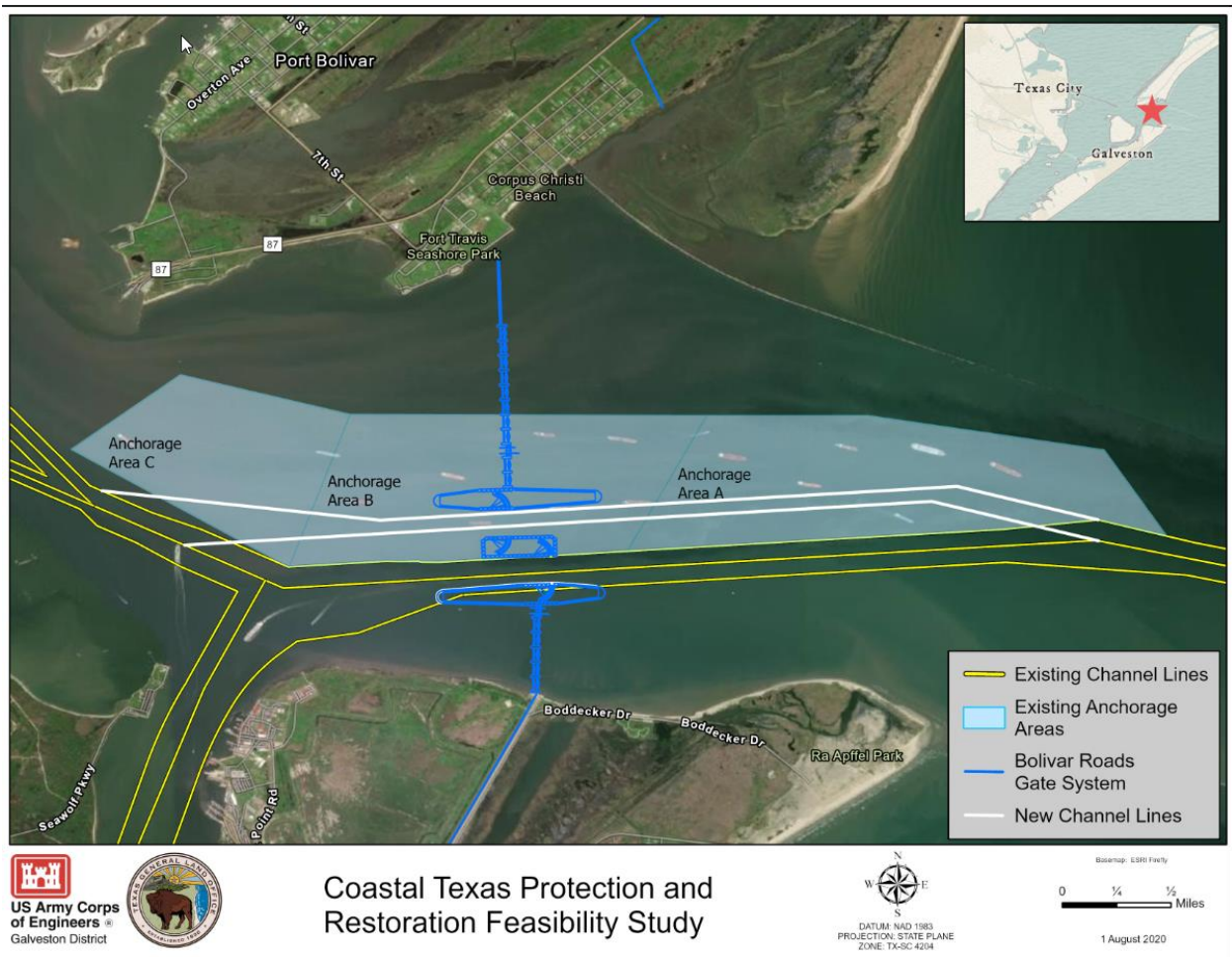

Figure 4-8: Existing Anchorage Areas A, B, and C

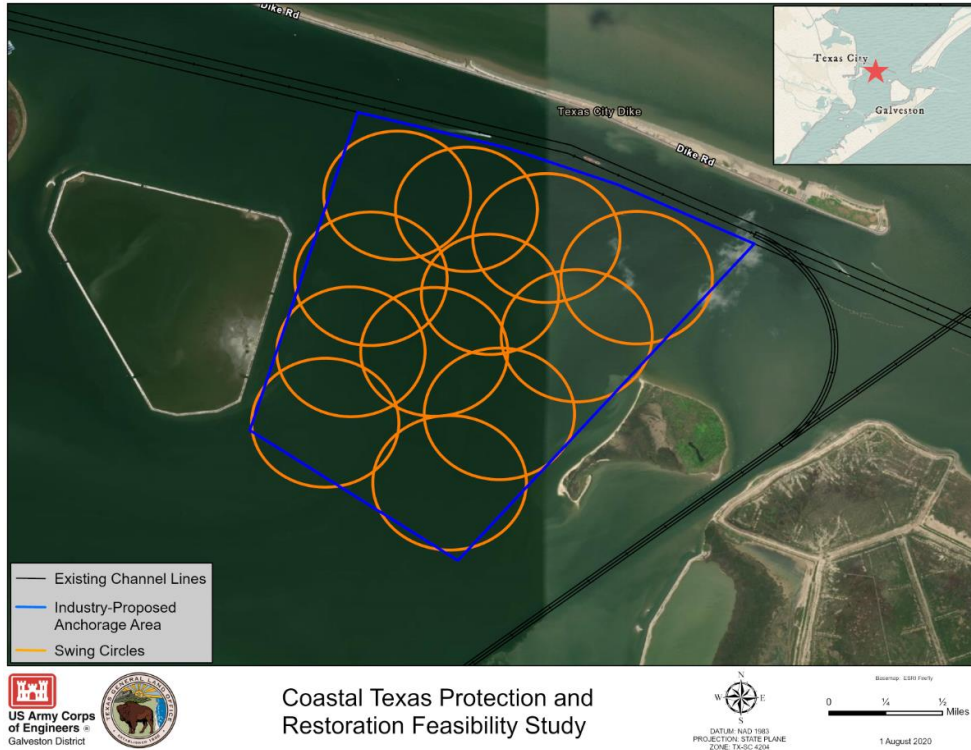

Figure 4-9: Anchorage Area Proposed by the Anchorage Working Group

The Anchorage Working Group proposed area has an existing bay bottom at approximately elevation - 5.0. Figure 4-9 shows 12 swing circles as desired by industry. The proposed area covers an area of 2.4 sq. miles and would require the relocation of an existing 24” pipeline and 86 MCY of dredging. Figure 4-10 below shows the existing and proposed study anchorage areas and number of swing circles associated with each area.

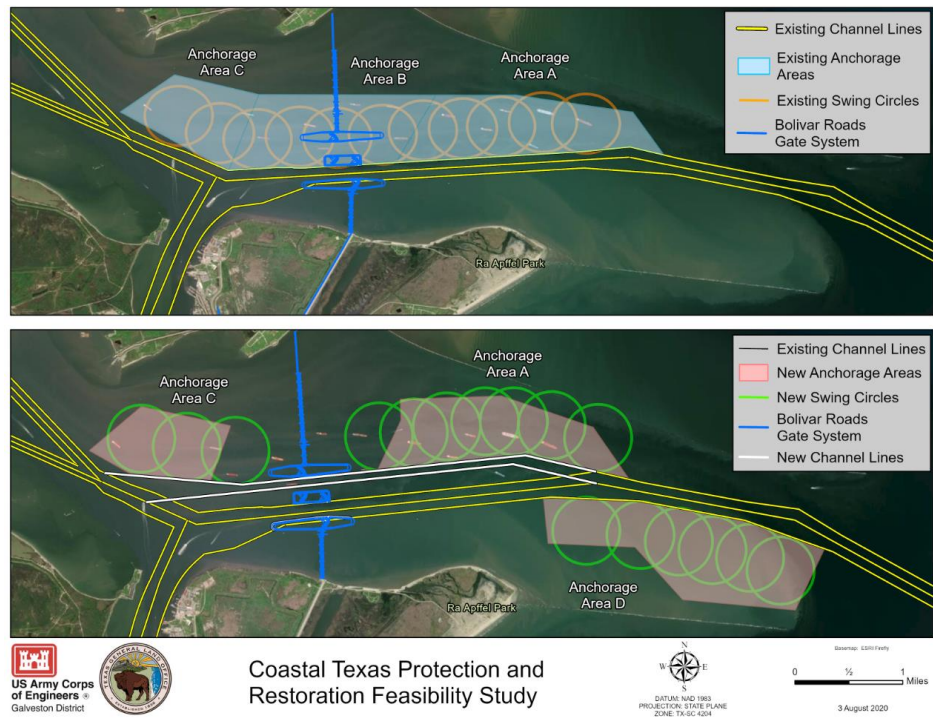

Figure 4-10: Existing and Proposed Study Anchorage Areas

The existing anchorage areas accommodate 11 swing circles (orange circles) and the proposed study anchorage areas provides 16 circles (green circles). The study anchorage areas like the existing anchorage areas are naturally deep and provide a depth comparable to the existing anchorage areas. The proposed study anchorage areas, like the site proposed by the Anchorage Working Group (Annex 16), provide a total area of 2.4 aq. miles. Due to the cost of the anchorage area proposed by the working group, anchorage areas A and D were carried forward. Additionally, due to concerns with currents for anchorage area D, the project estimate includes mooring points for vessels and associated tug assistance. Further detailed analysis will be conducted during PED.

4.3 GALVESTON ISLAND CONTROL/VISITOR CENTER

The Storm Surge Gate at Bolivar Roads crossing will also include a central control center on the Galveston side of the barrier (Figure 4-11). The Control Center will be located on the protected side of the barrier near the northeast corner of the San Jacinto Placement Area. The 5,000 square foot building would be on Government owned lands and would be accessible via the construction of a 0.32-mile all-weather concrete road from the existing USMC Reserve Center access road to the building location. The road would be aligned outside the San Jacinto Placement Area perimeter levee. The road would have a width of 30 foot and crown elevation of at least 21.5'. The Control Center would be elevated at elevation 21.5' and would be equipped with backup systems to allow for continued operation during power lost. The Control Center would also function as a Visitor Center. The Galveston Island Control Center site would also include a 2,500 SF Maintenance Shop for the repair/rehab of gate fixtures, storage

of maintenance equipment, spare parts, fuel, and lubricants. Additionally, to assure redundancy in the operation of the gates a 3,500 SF auxiliary control center would be located on Bolivar on the protected side of the levee near the intersection of 23rd and State Highway 87. The Bolivar Auxiliary Control Center would be at the same elevation as the Main Operation Center.

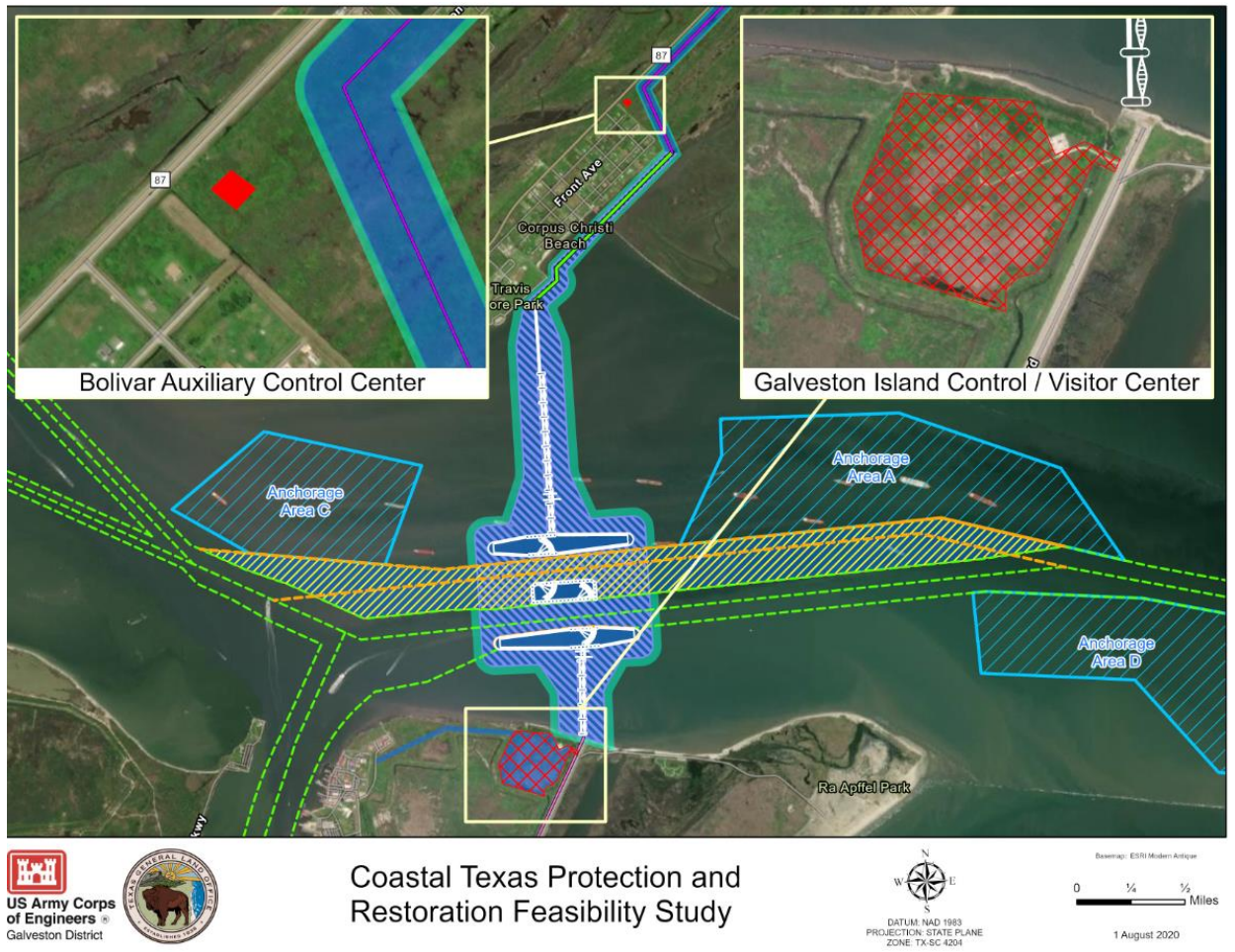

Figure 4-11: Operation Center

4.4 GALVESTON ISLAND RING BARRIER SYSTEM

The Galveston Ring Barrier System (GRBS) is proposed to reduce back-bay inundation of the city of Galveston (Figure 4-12). The system connects to the dune improvement and the levee and seawall. The GRBS is a system of floodwalls, gates, pump stations, and levee that provides flood risk management for approximately 15 square miles of the City of Galveston.

The proposed GRBS incorporates the existing Seawall and proceeds counterclockwise from the west end of the Seawall north in the proximity of 103rd street to Offatts Bayou, crosses the Teichman Point area and ties into I-45, continues east along the Harborside area to the 47th street area, then continues

north to the Galveston Ship Channel, then continues east through the Port of Galveston to UTMB, turns northward to the Ferry and then back south to the seawall.

The specifics of each reach along with rationale of why the current alignment was chosen is discussed in detail below. The attached mapbook (Annex 17) presents details of the GRPS footprints. Numerous tradeoffs between project cost, project impacts and overall effectiveness of the GRBS were evaluated and made during the refinement of the alignment. The team will continue to avoid and minimize impacts where possible as the system is optimized in the PED phase.



Figure 4-12: Galveston Ring Barrier System

4.4.1 Seawall Tie-in

The start of the GRBS is at the west end of the seawall tying into the existing backfill north of the north sidewalk of the seawall. This section of floodwall extends west, crosses Cove View Blvd. with two vehicle gates and continues west till the vicinity of the City soccer fields. The project feature here would be an inverted “T” concrete floodwall with a deep foundation and a top of wall elevation of +14 ft NAVD 88. Existing drainage would be maintained and modified as needed to avoid any impacts from the construction of the floodwall. The tie-in to the seawall was chosen to avoid needing to put gate closure structures across FM 3005. This allows for the west end of Galveston Island to remain open to traffic as long as possible during a flood event. This also places the tie in for the west floodwall of the

GRBS in a more resilient location, away from the high energy waves that the dune system will see, behind the seawall.

The uncertainties and opportunities remaining for this section include the refinement and optimization of the physical location and dimensions of the floodwall. This will be accomplished through refinement of the geotechnical, H&H, and structural analysis and coordination with property and utility owners and local authorities during PED.

4.4.1.1 Seawall Tie-in to Soccer Field Reach

The west floodwall of the GRBS continues north from FM 3005 adjacent to the city soccer fields, crosses Stewart Road with two vehicle gate structures and continues onto the Galveston Bay Foundation Sweetwater Preserve. The project feature here would be an inverted “T” concrete floodwall with a deep foundation and a top of wall elevation of +14 ft NAVD 88. Existing drainage will be maintained and modified as needed to avoid any impacts from the construction of the floodwall. Currently one drainage structure is proposed for this reach of floodwall. Locating the floodwall adjacent to and on city of Galveston property limits the impact to adjacent private property owners while taking advantage of the open areas and City land to utilize as staging areas. The staging area will have access to both of west Galveston’s major roadways. The vehicle closure structures at Stewart Road would be restricted during an event. The Stewart Road vehicle traffic will have to use FM 3005 during an event.

The uncertainties and opportunities remaining for this section include the refinement and optimization of the physical location and dimensions of the floodwall. This will be accomplished through refinement of the geotechnical, H&H, and structural analysis and coordination with property and utility owners and local authorities during PED. Evaluation of potential for wave and vessel loading could also have an impact on the proposed design.

4.4.1.2 Soccer Field to Galveston Bay Foundation Preserve Reach

The west floodwall of the GRBS continues north onto the Galveston Bay Foundation Sweetwater Preserve (GBF) till it reaches Offatts Bayou. The project feature here would be an inverted “T” concrete floodwall with a deep foundation and a top of wall elevation of +14 ft NAVD 88. Existing drainage will be maintained and modified as needed to avoid any impacts from the construction of the floodwall. Currently two drainage/circulation structures are proposed for this reach of floodwall and will allow for two-way water flow and be 14 ft wide, 10 ft tall with sill elevation at elevation -5. This section of floodwall has three access gates to maintain access and allow for maintenance of the GBF property. A small area of drainage impact mitigation is noted in this area to ensure that any impacts created by the construction can be addressed.

Locating the floodwall on GBF property limits the impact to adjacent property while taking advantage of the open undeveloped areas along the property boundaries and avoids dividing neighborhoods. The

staging area will have access to Stewart Road and will be restored to current condition when the project is complete.

The uncertainties and opportunities remaining for this section include the refinement and optimization of the physical location and dimensions of the floodwall. This will be accomplished through refinement of the geotechnical, H&H, and structural analysis and coordination with property and utility owners and local authorities during PED. Evaluation of potential for wave and vessel loading could also have an impact on the proposed design. Drainage impact mitigation other than those noted could be needed.

4.4.1.3 Offatts Bayou Crossing Reach

The closure of Offatts Bayou (Figure 4-13) starts at the edge of the GBF property continuing north then northeast offshore of the Teichman Point neighborhood then ending at the Offatts Bayou pump station adjacent to the Galveston Causeway. This project feature is a combination floodwall system (Combi-wall) that consists of vertical piling, batter piling and a concrete cap system. This feature also includes a section of shallow water environmental gates/water circulation gates and two navigation sector gates.

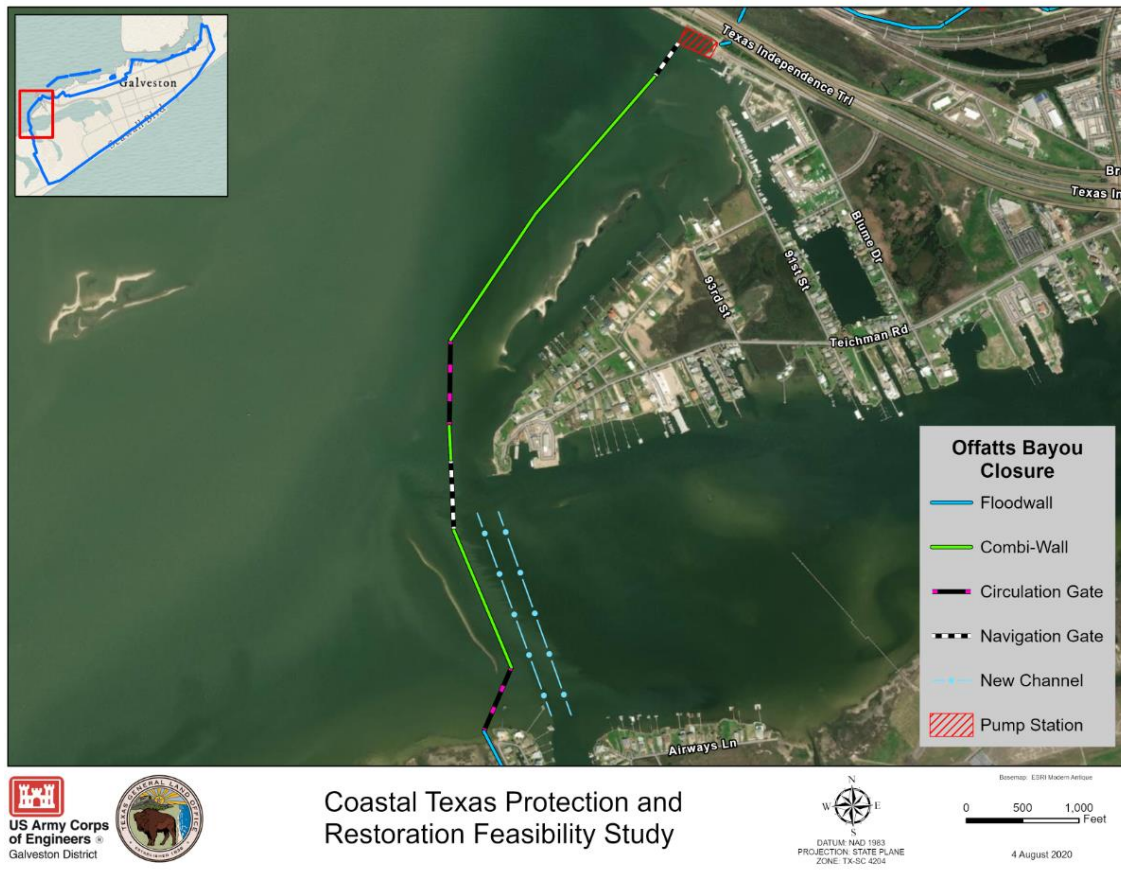

Figure 4-13: Offatts Bayou Crossing

The Offatts Bayou crossing in the Teichman Road neighborhood had two main alternatives evaluated during this process. They consisted of the chosen alignment and an alternate alignment that excluded the neighborhood from the GRBS. These alternatives were evaluated due to the limited benefits in the neighborhood due to most of the structures already being elevated and the community's opinion that the offshore floodwall would greatly impact the value and "fabric" of the neighborhood. The alternate alignment would have paralleled the shoreline of the crash boat basin neighborhood and placed the Offatts Bayou pump station adjacent to a residential area. The alternate alignment would have a "T" floodwall section with a road raising, road closures, and drainage features. The planning level assessment of the cost of the two alternatives resulted in the chosen alignment being taken forward in the study. An additional discussion of placing the floodwall along the shoreline was had and was not developed as an alternative due to the impacts on the existing residential structures. During the working group meetings, the placement of the floodwall along the shoreline was brought up by some of the attendees as a preferred option.

The Offatts Bayou crossing impacts the crash boat basin access channel, so a new channel is proposed as shown. The shallow water circulation gates are placed in areas where existing circulation will be impacted by the construction. The navigation gates are shown as sector gates to ensure the existing use of the channels are not impacted by the construction. The offshore floodwall is located in an area to limit impacts to known habitat.

The uncertainties and opportunities remaining for this section include the refinement and optimization of the physical location and dimensions of the floodwall. This will be accomplished through refinement of the geotechnical, H&H, and structural analysis and coordination with property and utility owners and local authorities during PED. Evaluation of potential for wave and vessel loading could also have an impact on the proposed design along with scour evaluation at the circulation and navigation features. The structure could also facilitate potential environmental improvements (sea grass, oysters, intertidal marsh, and improved circulation for Offatts Bayou) along the alignment.

4.4.1.4 Offatts Bayou Pump Station and Galveston Causeway to 77th street Reach

The Offatts Bayou pump station is a 4,000 CFS pump station that is located at the intersection of the combi-wall and the Galveston Causeway. The pump station is situated at this location to allow for easy access during operations and distance from residential structures. The sizing of this pump station will be refined during PED when the interior drainage analysis is updated.

The Galveston Causeway crossing is a floodwall and vehicle closure from the Offatts Bayou pump station to the bridge abutment. The high ground of the bridge abutment will be incorporated into the alignment as the project feature for the I-45 crossing. A "T" floodwall will then proceed to the east to the railroad bridge where the high ground of the railroad bridge will be incorporated into the alignment as the project feature for the railroad crossing. The "T" floodwall will continue east to southeast along

the railroad abutment and then loop out to include the natural gas facility, then continue east along Harborside Drive to 77th street. This section of floodwall is an inverted “T” concrete floodwall with a deep foundation and a top of wall elevation of +14. Existing drainage will be maintained and modified as needed to avoid any impacts from the construction of the floodwall. A circulation drainage structure is located on the floodwall section between I-45 and the railroad bridge and a storm water drainage structure is located near the natural gas facility.

The utilization of the bridge abutments for crossing I-45 and the railroad bridge allows for GRBS to avoid closing off access to the Island. This alignment also limits impacts to the continuous functionality of the rail lines on and off the Island. The inclusion of the natural gas facility provides flood risk management to critical infrastructure.

The uncertainties and opportunities remaining for this section include the refinement and optimization of the physical location and dimensions of the floodwall. This will be accomplished through refinement of the geotechnical, H&H, and structural analysis and coordination with property and utility owners and local authorities during PED. Evaluation of potential for wave and vessel loading could also have an impact on the proposed design. Drainage impact mitigation other than those noted could be needed including a small pump station to address any ponding of water when the storm water drainage structure is closed.

4.4.1.5 77th Street Crossing and Nonstructural Measures for Channelview Neighborhood

The 77th street crossing is proposed to be an elevated roadway crossing to eliminate the need for a gate structure and avoid locking out the residents located outside of the GRBS. This will allow for continuous access to the Channelview and Pruitt streets during an event. The road raising will consist of a floodwall that will be buried under the roadway along with retaining walls that will allow for the entire roadway to be raised from Pruitt to Harborside Drive.

A portion of the residential homes in the Channelview Neighborhood are already raised to prevent inundation from coastal storm surges, however a portion of the homes on the interior streets are still slab on grade homes. Due to the close proximity of residential structures to the floodwall and due to concerns with wave action deflecting off the floodwall, mitigation measures are being included in the recommendation to address the uncertainty surrounding the issue.

Offshore breakwaters (Green lines on Figure 4-14) are being recommended to reduce the wave climate during storm events to mitigation part of the risk. Nonstructural measures in the Channelview neighborhood (yellow cross hashed area) for residential structures would also be included in the recommendation to address the elevated water levels due to the proximity to the floodwall. In order to address the concern, a cost for voluntary elevating homes or voluntary buying homes out was developed. Due to the uncertainty in the type of home and the ability to raise every home, the higher cost, buying

out homes will be carried forward in the recommendation. In PED the existing surge risk and inducement surge risk when the floodwall is built will be further investigated. This will determine if the nonstructural mitigation measures need to be implemented.



Figure 4-14: Offshore Breakwater

4.4.1.6 77th Street to 47th Street Pump Station

The alignment through the Harborside area from 77th street to the 47th street pump station, goes south from the 77th street crossing then east adjacent to the railroad track, then under the 51st street bridge to the 47th street pump station. This section of floodwall is an inverted “T” concrete floodwall with a deep foundation and a top of wall elevation of +14 ft NAVD88. Existing drainage will be maintained and modified as needed to avoid any impacts from the construction of the floodwall. This reach also includes an offshore breakwater to mitigate the wave impacts along the residential area and industrial area.

The alternate alignments evaluated through this area included an alignment along the north side, south side and middle of Harborside drive, and immediately south of the industrial area along Harborside drive. The impacts of these alignments on the industrial area and traffic on Harborside were significant and the efforts to minimize the impacts resulted in the presented alignment. The proposed alignment limits the number of gate closure structures for rail and roads and maintains a comparable length to keep similar cost. This reach also includes a structural measure at the wastewater treatment facility at 51st.

This measure is currently evaluated as a floodwall but could potentially be reduced in scope or possibly eliminated in PED after the facility is thoroughly evaluated.

The uncertainties and opportunities remaining for this section include the refinement and optimization of the physical location and dimensions of the floodwall. This will be accomplished through refinement of the geotechnical, H&H, and structural analysis and coordination with property and utility owners and local authorities during PED. Evaluation of potential for wave and vessel loading could also have an impact on the proposed design. Drainage impact mitigation other than those noted could be needed.

4.4.1.7 Pump Station at 47th Street.

The pump station at 47th Street is a 4,000 CFS pump station that includes gravity drainage and drainage impact mitigation features that extend from Galveston Bay to 27th Street. The pump station is situated at this location to allow for easy access during operations and distance from residential structures. The sizing of this pump station will be refined during PED when the interior drainage analysis is updated. This pump station will have gravity drainage features that allow for the drainage of rainfall without the operation of the pumps.

This pump station also has two significant drainage impact mitigation features. The first drainage feature is the outlet channel. The pump station is located inland and will need to have a discharge channel constructed through an area that has significant existing railroad infrastructure. This will require replacing culverts along rail lines with bridges to allow for the flow of the water from the pump station to Galveston Bay. There is also a road that will need to be modified with a bridge to allow for the increased flow. The second drainage feature is an intake canal that will bring water to the pump station. This feature is needed to intersect some of the existing gravity drainage systems that will be cut off during construction and operation of the GRBS. This feature will proceed from the pump station at 47th Street, generally along the Mechanic Street corridor to 28th Street and will be a combination of open channel and very large buried drainage conduit. The sizing of these drainage impact mitigation features will be refined during PED when the interior drainage analysis is updated.

4.4.1.8 47th Street Pump Station thru Port of Galveston to 19th Street.

The alignment from the 47th Street pump station thru the Port of Galveston to the Pier 19 area is a combination of features including floodwall, moveable floodwall sections and large vehicle closure structures. The alignment starts at the 47th Street pump station then proceeds east to the Harborside Drive bridge abutment. The system turns north and passes through the bridge abutment incorporating the bridge abutment into the alignment then continues across the rail lines and proceeds in a north-northeast direction to the Galveston Ship Channel. This section of floodwall is an inverted “T” concrete floodwall with a deep foundation and a top of wall elevation of +14 ft NAVD88. The alignment then turns east and proceeds across the dock and closes off the three existing shipping slips. This section of floodwall is also “T” concrete floodwall with a deep foundation and a top of wall elevation of +14 ft

NAVD 88. The floodwall would include a stick-up height above ground of approximately 3 ft with limited areas of 4 ft stick up height. The alignment continues east as a moveable floodwall section through the laydown area. The floodwall would a moveable “stem” section, with the foundation, and footing below ground. The alignment then weaves through the grain elevator area and the cruise ship terminal to the Pier 19 area. This section of floodwall is back to a “T” concrete floodwall with a deep foundation and a top of wall elevation of +14. The floodwall would have a stick-up height above ground of approximately 6 ft with limited areas of 8 ft stick up height. Existing drainage will be maintained and modified as needed to avoid any impacts from the construction of the floodwall.

The alignment in this area was chosen to eliminate any vehicle closure gates on Harborside Drive, minimize cutting up Port facilities and adjusted to along with the Port of Galveston master plan. The Coordination with the Port allowed the proposed alignment to eliminate a significant number of vehicle closures and provide a shorter length of floodwall than was originally proposed. This coordination should continue in PED to further refine and enhance the project features in the Port facility.

The uncertainties and opportunities remaining for this section include the refinement and optimization of the physical location and dimensions of the floodwall and other project features. This will be accomplished through refinement of the geotechnical, H&H, and structural analysis and coordination with property and utility owners and local authorities during PED. Evaluation of potential for wave and vessel loading could also have an impact on the proposed design. Drainage impact mitigation other than those noted could be needed.

4.4.1.9 Pier 19 Reach

The project features and alignment through the Pier 19 area was refined to match up with the proposed land use changes in the Port of Galveston master plan. These changes allowed for the alignment to adjust and reduce impacts to access and operations within the area. This also allowed for the elimination of rail closure structures and the consolidation of vehicle and access closure structures. This section of floodwall is an inverted “T” concrete floodwall with a deep foundation and a top of wall elevation of +14 ft NAVD88. The floodwall has a stick-up height above ground of approximately 6 ft.

The proposed pump station in this area is a 1500 CFS pump station. The location of this pump station is currently shown at Pier 19, this is being coordinated with the City of Galveston and will likely shift in PED to Pier 16 where the City is currently in design phase for a City owned pump station. The size and final location of the Federal Project pump station will be determined during PED with close coordination with the City of Galveston.

The uncertainties and opportunities remaining for this section include the refinement and optimization of the physical location and dimensions of the floodwall and other project features. This will be accomplished through refinement of the geotechnical, H&H, and structural analysis and coordination

with property and utility owners and local authorities during PED. Evaluation of potential for wave and vessel loading could also have an impact on the proposed design. Drainage impact mitigation other than those noted could be needed, along with revision of pump station location and capacity. The visual appearance of the floodwall in this area is also an opportunity to partner with the local community to allow for a coordinated effort to enhance the features.

4.4.1.10 Pier 19 thru Port of Galveston to UTMB

The project features and alignment from Pier 19 thru the Port was refined to match up with the proposed land use changes in the Port of Galveston master plan. These changes allowed for the alignment to adjust and reduce impacts to access and operations within the area. This also allowed for shorting of the alignment, the elimination of rail closure structures and the consolidation of vehicle and access closure structures. This section of floodwall is an inverted “T” concrete floodwall with a deep foundation and a top of wall elevation of +14 ft NAVD 88. The floodwall would a stick-up height above ground of approximately 8 ft. Existing drainage will be maintained and modified as needed to avoid any impacts from the construction of the floodwall.

The uncertainties and opportunities remaining for this section include the refinement and optimization of the physical location and dimensions of the floodwall and other project features. This will be accomplished through refinement of the geotechnical, H&H, and structural analysis and coordination with property and utility owners and local authorities during PED. Evaluation of potential for wave and vessel loading could also have an impact on the proposed design. Drainage impact mitigation other than those noted could be needed. Coordination with the City of Galveston on pump station construction at Pier 16 and the Port of Galveston on master plan implementation will be crucial for the PED phase of the project.

4.4.1.11 UTMB to Harborview Reach

The alignment of the GRBS through UTMB generally goes east from the Port of Galveston property, follows the shoreline near the helipad, turns north along the dock area then east toward the PCP then north-northeast to the Galveston Yacht Basin then continues to shoreline at Harborview. This section is an inverted “T” concrete floodwall with a deep foundation and a top of wall elevation of +14 ft NAVD88. The floodwall would have stick up height above ground of approximately 8 ft with some areas up to 12 ft. This reach also has a pump station and some drainage impact mitigation features.

This reach was coordinated with UTMB and the initial alignment was adjusted to remove numerous closure structures and relocate the pump station away from critical infrastructure. These changes allowed for a reduction in the length, complexity and impacts of the system. Additional coordination during PED could further enhance the project in this area. The alignment thru the Galveston Yacht Basin was chosen to reduce the number of closure structures while not impacting accessibility, coordination

during PED is needed to reduce any impacts and capitalize on any opportunities to increase benefits in this area.

The proposed pump station at UTMB is a 4,000 CFS pump station. The location is currently shown on UTMB property adjacent to a channel off of the Galveston Ship Channel. This pump station would require drainage features to bring the water to the pump station. These features would tie into the existing city drainage outlet that is in the vicinity of the proposed pump station.

The uncertainties and opportunities remaining for this section include the refinement and optimization of the physical location and dimensions of the floodwall and other project features. This will be accomplished through refinement of the geotechnical, H&H, and structural analysis and coordination with property and utility owners and local authorities during PED. Evaluation of potential for wave and vessel loading could also have an impact on the proposed design. Drainage impact mitigation other than those noted could be needed.

4.4.1.12 Lindale Neighborhood/Harborview Drive

The alignment of the GRBS along Harborview Drive is located along the waterfront on top of and incorporated into the existing old stone Jetty. This feature would require raising the existing jetty to EL 14 ft. and implementing seepage control measures to address any seepage issues through the foundation and structure of the old jetty. These features would be constructed on and within the old jetty and would not extend to the residential structures but could impact pools or other backyard structures.

An alternate feature for this reach could be to raise the residential structures and place a floodwall structure beneath the homes then backfill with acceptable fill to place the alignment underneath the homes. This would be evasive to the homeowners but would potentially allow for a less expensive feature that could ultimately be less intrusive than raising the jetty.

The uncertainties and opportunities remaining for this section include the refinement and optimization of the physical location and dimensions of the floodwall and other project features. This will be accomplished through refinement of the geotechnical, H&H, and structural analysis and coordination with property and utility owners and local authorities during PED. Evaluation of potential for wave and vessel loading could also have an impact on the proposed design. Drainage impact mitigation other than those noted could be needed.

4.4.1.13 Ferry Landing to Galveston Seawall East End Reach

The GRBS alignment continues from the north end of Harborview as floodwall going east across Ferry Road to the Fort Point Road pump station then crossing Fort Point Road then turning south along the San Jacinto placement area as an existing levee to the Galveston Seawall. This section is an inverted “T” concrete floodwall with a deep foundation and a top of wall elevation of +14. The floodwall would

a stick-up height above ground of approximately 6 ft with some areas up to 10 ft. This reach also has a pump station and some drainage impact mitigation features along with a levee section.

The proposed pump station at Fort Point Road is a 1500 CFS pump station. The location is currently shown adjacent to Fort Point Road and would require drainage features to bring the water to the pump station and out to the Galveston Ship Channel. These features would tie into the existing city drainage outlet that is in the vicinity of the proposed pump station. The pump station would include gravity drainage features that would allow for drainage without running the pumps.

The uncertainties and opportunities remaining for this section include the refinement and optimization of the physical location and dimensions of the floodwall and other project features. This will be accomplished through refinement of the geotechnical, H&H, and structural analysis and coordination with property and utility owners and local authorities during PED. Evaluation of potential for wave and vessel loading could also have an impact on the proposed design. Drainage impact mitigation other than those noted could be needed and refinement of the pump station capacity will be conducted in PED.

4.4.1.14 Galveston Seawall Extension

The Galveston seawall improvement feature is a future adaptation to provide additional storm surge and wave overtopping reduction along Galveston Island, which will connect to the storm surge gate at Bolivar Roads and the beach dune system. The recommendation is to increase the height of 10 miles of the existing seawall to reach a uniform level of protection of 21.0 ft (NAVD88). The initial design of the Galveston seawall provided protection (the upward and outward curved section of the wall) to 17.0 feet (NAVD88). Subsequent modifications to the roadway and earthen embankment raised the combined level of protection to 21.0 ft (NAVD88). This higher elevation will significantly reduce the wave overtopping volume and pump capacity needs during extreme events. However, these elevations are not consistent across the entire seawall feature. Modifications and development over the years along with design changes during subsequent seawall extensions have resulted in the earthen embankment being non-uniform in height. To address this concern and ensure a uniform elevation of 21.0 (NAVD88), an extension of the north sheet pile cutoff wall located at the north edge of the north sidewalk is proposed. This extension is a 3ft vertical wall that would have gated openings for vehicle and pedestrian access. The extension would go from the San Jacinto levee seawall tie-in to the west end tie in of the GRBS. A road raising at 89th Street would allow for continued access to the west end of the Island during a storm surge event

4.4.1.15 Pump Stations and Drainage outlets associated with GRBS

As discussed above, the GRBS includes a series of pump stations and drainage outlets. While the majority of drainage systems in the Galveston area are gravity driven, the City of Galveston is continuing to make improvements to the system, including forced, or pumped, drainage systems. The

USACE will continue to work with the City to ensure that there are not conflicts between the City's current or existing plans and the Recommended Plan.

As discussed above, the GRBS system would include series of drainage outlet structures to allow water exchange and hydrologic connectivity. This hydrologic connectivity would be maintained to the extent practicable through water control structures, except during closure for hurricanes or tropical storms. When these gates are closed, the pump stations will need to operate to remove water due to rainfall and/or wave overtopping from within the GRBS. While the pumps are initially designed to handle 25-year rainfall with surge tail water boundary conditions of 1% ACE (Section 2.0), the compound interaction of rainfall and surge has not been fully explored in this phase of the study. The operation criteria of the gates and pump stations will need to be fully assessed in the PED phase. The gate operations will be depended on the intensity, track and orientation of the landfalling storm which will dictate the trigger condition (e.g., 3m TWL) of gate closings. Pumps will be operated when the intake water level is higher than the outfall water level. This expected rate of closure would be the same regardless of the actual rate of relative sea level rise, as closure of the system is tied to tropical storm events and the elevation trigger would be adjusted as sea level rises. The risk reduction system is only authorized to address storm surge caused by hurricane and tropical storm events. It is not authorized to mitigate for or reduce impacts caused by higher day-to-day water levels brought about by increases in sea level rise. To manage rainfall induced flooding of the areas behind the structure, all drainage features through the system were sized to match the existing capacity of the gravity drainage system and will mimic the existing drainage patterns when the system is not closed. Any operational changes implemented to address changing sea level conditions, or for any other non-project-related purpose, would be considered a separate project purpose requiring separate authorization, new NEPA documentation, and/or permit approvals.

The non-Federal sponsor will have obligations related to the operation of the project, specifically the pump stations, to prevent encroachments that would impact the utility of the project when the pump station is operating. The non-Federal sponsor will be required to comply with flood plain management requirements and ensure that project features, such as pump stations, would not be impacted by developments in the areas behind the risk reduction system. The pump system designed to match the existing gravity drainage capacity when the system is closed. The non-Federal sponsor will have the responsibility to ensure that this operation of the project features is maintained.

4.5 **DICKINSON BAY GATE**

Features at Dickinson Bay west of Highway 146 consist of sector gate, associated combi-wall, and pump station. The current authorized dimensions of the channel are a 60-foot width and a depth of -9 feet MLLW, which includes an advanced maintenance depth. The alignment of the gates and associated wall would be along the abandoned railroad ROW. The gate opening across Dickinson Bay is at 100-

foot to allow for additional flow area. End points for the combi-wall will be further analyzed post TSP. The elevation of the wall and gate is 18.0 feet.



Figure 4-15: Dickinson Bay Gate System

4.6 CLEAR LAKE CHANNEL AND GATE

Features at Clear Lake Channel west of Highway 146 consists of sector gate across the channel, associated barrier wall and pump station. The current authorized dimensions of the channel are a 75 feet width and a depth of -10 feet MLLW, which includes an advanced maintenance depth. The Clear Lake Channel is currently not maintained. The alignment of the gates and associated wall will be along the abandoned railroad right-of-way (ROW). The elevation of the wall and gate is 17.0 feet.



Figure 4-16: Clear Lake Gate Closure System

5.0 **BEACH AND DUNE SYSTEM DESIGN – BOLIVAR & WEST GALVESTON**

This section of the report summarizes beach and dune system design with evaluation of drainage along Bolivar and West Galveston. Details can be found in Annex 18

5.1 **SCOPE OF WORK**

The upper Texas coastline is retreating on the order of 2 to 5 feet per year in the study area, according to long-term trends that are based on comparison of aerial photographs and surveys (HDR, 2014; Paine, 2014). Shoreline change rates vary spatially and temporally due to a multitude of dynamic influential factors, which include, but are not limited to, sediment supply & characteristics, storm events, shoreline planform shape, offshore profile shape, sea level change and human intervention. Spatial variation in shoreline change rates are heavily influenced by the presence of manmade structures, which can impact sediment supply and transportation patterns. For example, the Bureau of Economic Geology reports net shoreline advance on Galveston Island's East Beach at an average rate of 12.5 feet per year between the 1930's and 2012, while the region within the study site (west of the seawall) experienced retreat at 3.2 feet per year during the same period (Paine, 2014). The maximum average historic shoreline recession rate on Galveston Island occurs near the west end of the seawall, where the shoreline retreats at a rate upwards of 8.85 feet per year. These patterns are largely attributed to the existence of coastal structures such as the Galveston Seawall, and the Galveston Ship Channel jetties. The jetties contribute to long-term shoreline advance on Galveston's East Beach and western Bolivar Peninsula, while the remainder of the peninsula experiences long-term shoreline retreat at an average rate of 4-5 feet per year (Paine, 2014).

Long-term shoreline change can be attributed in part to ambient littoral drift patterns, which predominantly transport sediment southwest along the Texas coastline. However, impact from littoral drift is limited to a relatively narrow swath of the nearshore region. Severe storms are responsible for the most dramatic erosional impacts that shape the upper Texas shoreline and are even capable of changing littoral patterns. The extent and magnitude of energy associated with extreme events can eliminate dune systems and suspend sediment at depths that would otherwise remain undisturbed. Dr. Tim Dellapenna estimates sediment losses at upwards of 103 million cubic yards of sediment removed from Galveston Island's beach and shoreface, attributed to Ike (Dellapenna, 2012). Estimates are based on a comparison of beach and shoreface surveys conducted in 2006 (pre-Ike), and in 2011 after a 3-year recovery period that includes added volume of beach nourishment material. Further, Dr. Dellapenna notes that the estimate is likely conservative since surveys of the western 3.7 miles of the shoreface were unavailable. Events like Hurricane Ike can remove sediment from the system, forcing it landward of the beach, or seaward to unrecoverable depths. This point is highlighted in an HDR report on post-Ike shoreline recovery, prepared for the Texas Government Land Office (GLO), which indicates that

complete recovery of a beach (to its pre-storm condition) is sometimes not possible, and that erosion of cohesive sediments is generally irreversible (HDR, 2014). Further, the natural recovery of dune systems is a process that takes years and requires a healthy supply of sediment on the beach.

The purpose of this portion of the study is to investigate the feasibility of nature-based solutions that would improve natural coastal protection along Bolivar Peninsula and West Galveston Island. The Bolivar Peninsula study area includes ~25 miles of coastline between High Island and Fort Travis, and the Galveston Island study area includes ~18 miles of coastline between the end of the seawall and San Luis Pass. These regions are identified as Coastal Storm Risk Management (CSRМ) areas due to the relative population density of inhabitants. The region is characterized by its sandy barrier island terrain with two bay inlets including San Luis Pass at the western end of the site, and the Galveston Entrance Channel entrance, which separates Bolivar Peninsula from Galveston Island. The landward (cross-shore) project limit is the CSRМ alignment, a shore-parallel line approximately equivalent to the leeward toe of the existing dune system. The CSRМ line serves as the baseline (zero point) for the development of all cross-shore profiles.

5.1.1 Representative Existing Conditions Profiles

Beach and offshore profile surveys of the study site that were collected by Texas A&M in 2006 are used in conjunction with 2016 LiDAR (Light Detection and Ranging) survey (includes partial coverage of the study site). The surveys extend approximately one-mile offshore, to depths of approximately 20 feet below mean-lower low water. Excel, GIS mapping software (Esri ArcMap), and BMAP (Beach Morphology Analysis Package) software are used for pre- and post-processing survey data and to identify contiguous, morphologically similar reaches of shoreline, from which a set of representative cross-shore profiles are developed. The plan-view of Galveston transects is seen in Figure 5-1, which includes the CSRМ “baseline” that spans the alongshore distance of the Galveston study site. The CSRМ line is color-coded to represent morphologically similar reaches that were combined to create representative profiles in Galveston.

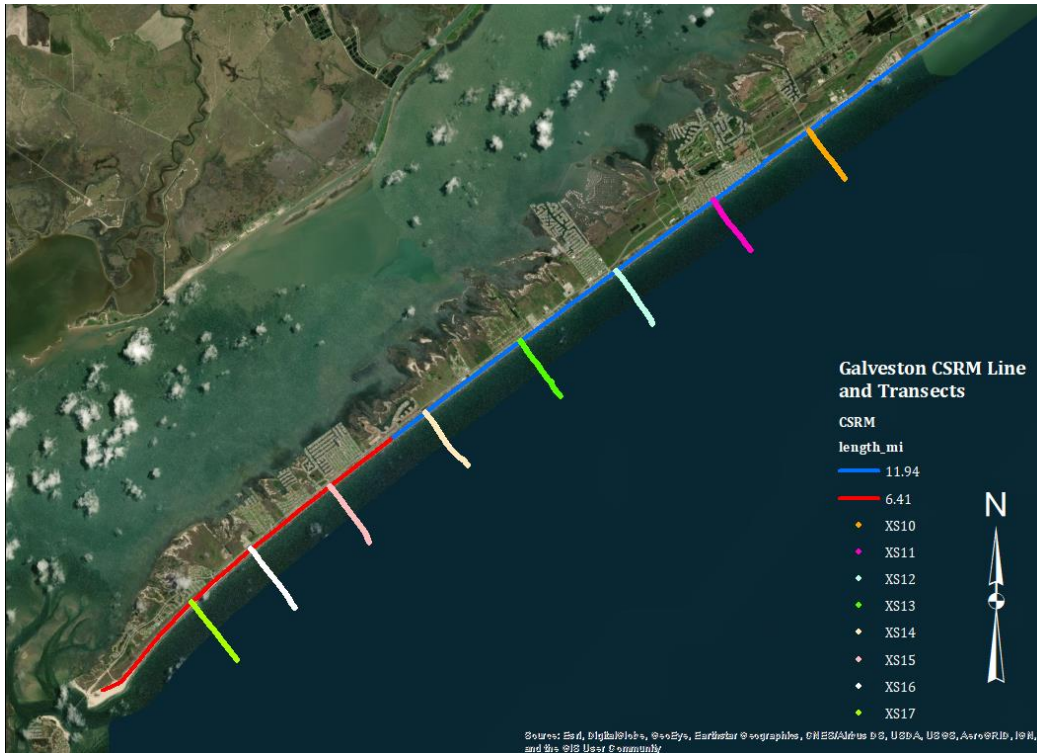

Figure 5-1: Map of Galveston CSR line and corresponding morphologically similar transects

Transect coordinate and elevation data from the 2006 Texas A&M survey are imported into ArcMap in addition to the 2016 LiDAR DEM and CSR coordinates spaced at 1-foot intervals alongshore. Elevation data is extracted from the 2016 DEM at transect coordinates located in Galveston. The transect elevation data is used to categorize morphologically similar reaches of shoreline.

Data landward of the CSR line is removed from transects so that the baseline is the CSR line and transect data is interpolated to 1-foot cross-shore intervals. The profiles are imported into BMAP and superimposed onto other profiles in the same morphologically similar reach.

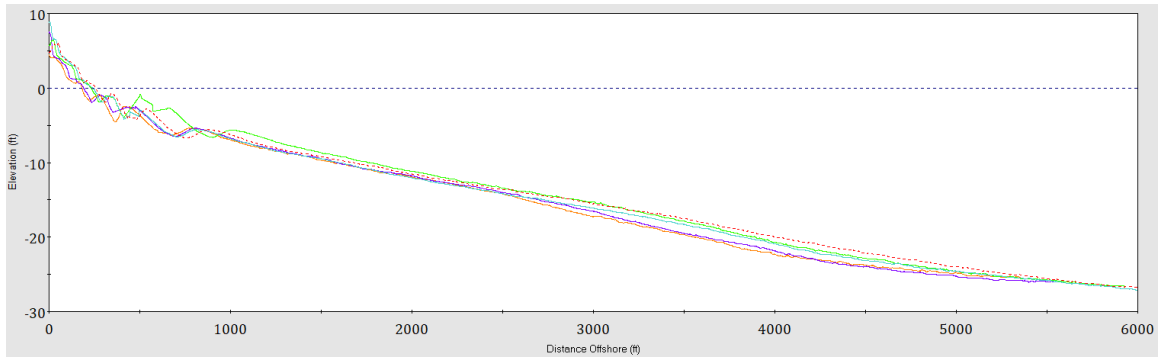

Figure 5-2: Five morphologically similar 2016 reaches identified on Galveston, profiles are averaged in BMAP to create representative cross section

The profiles are averaged in BMAP to create four CSRMs cross-sections intended to represent two distinct reaches on West Galveston and two reaches on Bolivar Peninsula. The profiles, or reaches, are exported to SBEACH and reach configuration options are set up.

5.1.2 Initial Design Profile

A healthy beach system is typically comprised of a system of one or more dunes and berms, both of which are ephemeral features that are elevated and landward of the surf zone. The dune complex is intended to be less ephemeral and self-maintaining in the proper environment and at a position sufficiently landward of the water. A beach profile typically has one or more berms situated between the dune and surf zone. Berms are dynamic features that are constantly being shaped by wave runup and aeolian processes. A healthy berm functions as a buffer zone that dissipates most incident storm waves prior to their arrival at the toe of the dune. This allows vegetation to proliferate on the dune, which gives rise to seaward dune growth through aeolian processes, and further strengthening the dune's resistance to storm surge and wave attack.

A range of initial design profile dimensions and configurations are developed for trial simulations based existing conditions and beach equilibrium profile theory concepts that are outlined in Part V, Chapter 4 of the USACE Coastal Engineering Manual.

Dune Configuration: Dune Beach Configuration and Dune Field & Beach Configuration

Dune Composition: Sand / Hardened Core

Dune Side Slopes: 1:3 to 1:5

Dune Crest Elevation: 10' to 18' (NAVD 88)

Dune Crest Width: 12' to 16'

Berm Slope: flat / 1:100 / 1:150

Berm Top Elevation: 4' to 6' (NAVD 88)

Berm Width: 0' / 30' / 60' / 100' / 150' / 200'

The existing elevation at the CSRM line serves as the starting elevation for the leeward toe of the design dune profile.

The minimum dune crest elevation is based on local average elevations observed in regions with more developed dunes. The crest width is based on the ratio between crest height and width seen in CEM examples. The minimum top of the berm elevation is based on the 2% runup limit elevation (with setup) calculated for a 10-year return event according to the WIS (Wave Information Studies) wave hindcast data at stations offshore of Galveston (73073) and Bolivar (73077). Runup with setup is calculated at approximately +4' (NAVD88) with the empirically based Stockdon method and modified Mase method formulas (Melby 2012).

According to the CEM V-4, the shape of the design profile below the beach berm is a function of the local morphology and grain size of the fill. For placement of fill with equal grain size, the remainder of the design profile beyond the added berm width is determined by translating the existing profile between the elevation of the design berm end and the depth of closure.

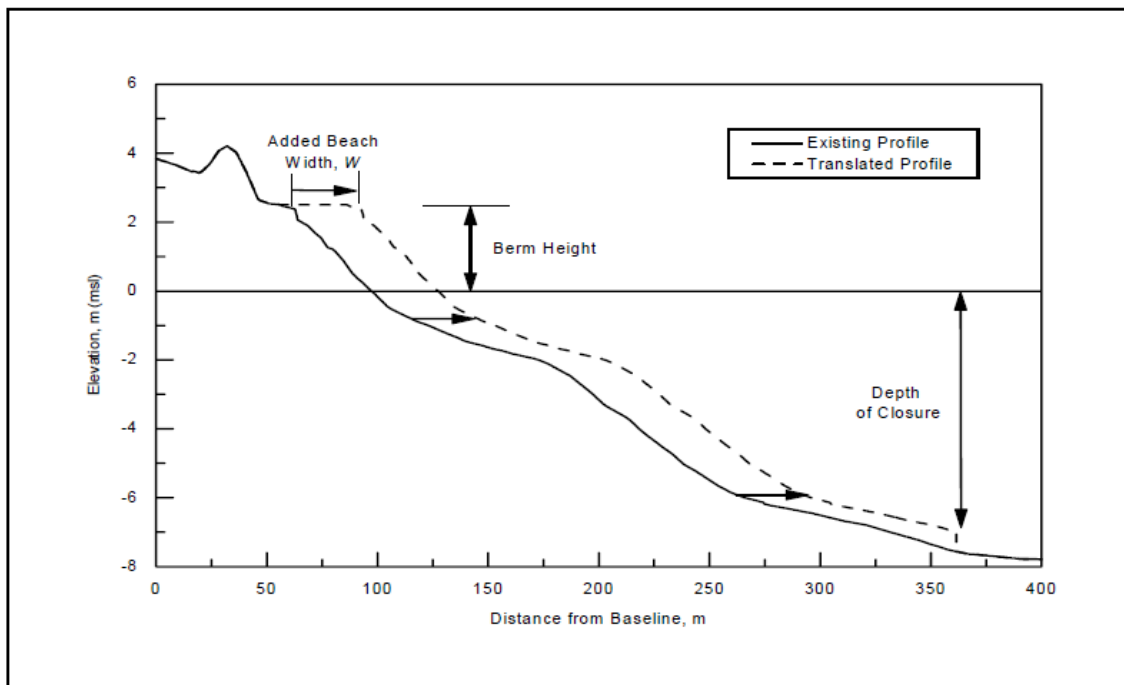

Figure 5-3: Design profile translation (CEM Figure V-4-14) graphically represented

The depth of closure (DOC) serves as the end point of the translated profile, where it ties back into the existing profile. The DOC is the theoretical depth at which energy from overhead waves is unable to suspend sediment at the seafloor. It is dependent on input wave, water level and sediment parameters, depending on the calculation method. For the purposes of this study, the DOC is calculated with the Hallermier equation in BMAP at approximately 15' deep for normal conditions. The DOC is typically the offshore extent of beach equilibrium profiles.

5.1.3 Construction Template

It is important to note that the design profile is intended to provide an estimation of the profile shape over time to develop volume calculations, it is not intended as a construction template. Typically, construction of the beach fill is completed close to shore rather than over the extent of the design profile, by over-building the berm beyond the intended design width to equal the design volume. The design profile is eventually reached by allowing natural processes to distribute sand along the profile, as seen in CEM Figure V-4-2 (Figure 5-4).

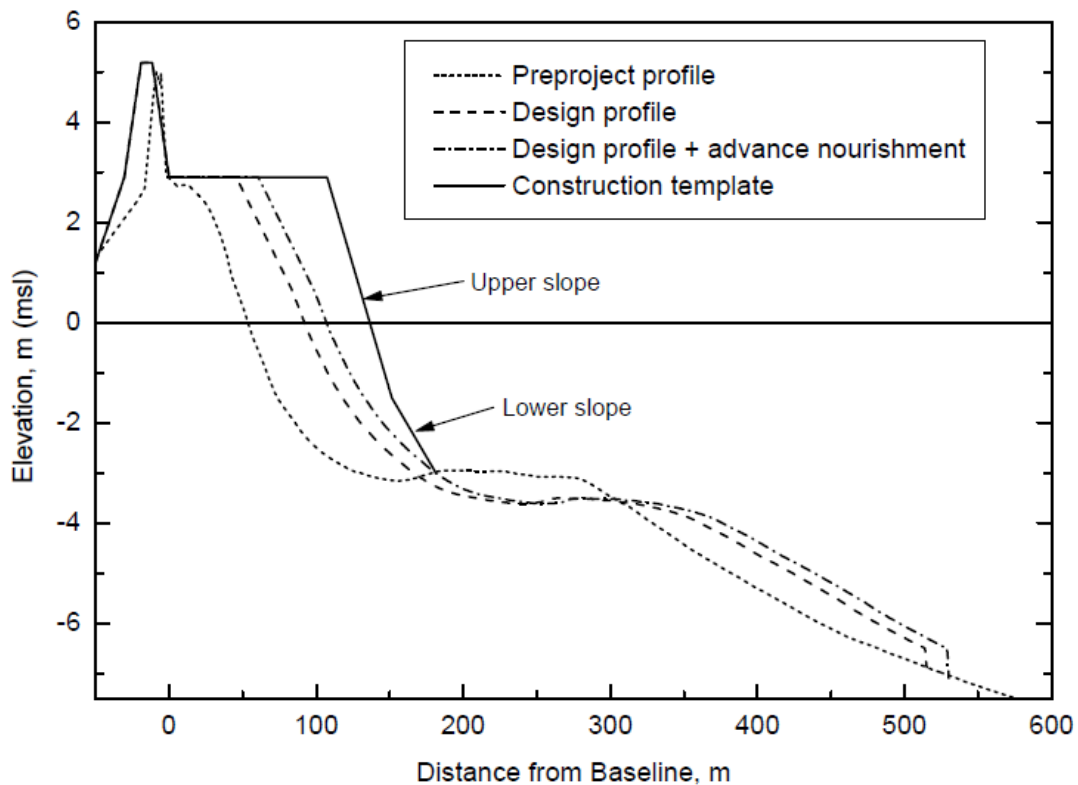

Figure 5-4: Construction template superimposed over design profile; CEM Figure V-4-33

A construction template generally begins at the seaward toe of the dune and is built to a volume that includes design fill, advanced fill, and overfill required beyond the seaward toe of the dune. Design

estimates were developed under the assumption that borrow fill sediment characteristics are equivalent to that of the native fill.

BMAP software provides automated tools derived from this equation, which can be used to match a theoretical beach equilibrium profile and equivalent theoretical grain size to actual transects. A summary of reported average sampled sediment grain sizes for each region is compared to equivalent theoretical grain sizes, derived from representative profiles with BMAP.

Table 5-1: Comparison of reported average grain size to theoretical equivalent grain size per region of study site

Region	Representative Profile	Reported d₅₀ Grain Size (mm)	Theoretical d₅₀ Grain Size (mm)
CSR: Bolivar Peninsula	XS1	0.16	0.06
	XS2		0.07
CSR: West Galveston Island	XS1	0.13	0.08
	XS2		0.07
ER: Follets Island	XS1	0.14	0.07
	XS2		0.09

The theoretical grain sizes are consistently lower than reported values, indicating that reported samples may not be representative of the average sediment size across the entire profile. The reported values are more consistent with the initial slope of the beach and shore face. The theoretical values are used to determine AN, the A-parameter associated with the native fill, and reported values are assumed to represent AF for the placed beach fill. Results indicate a steeper profile with a net reduction in volume required to create the design profile assuming borrow fill sediment is consistent with reported beach fill. The beach equilibrium profile concept is applied to Galveston XS1 in Figure 5-5.

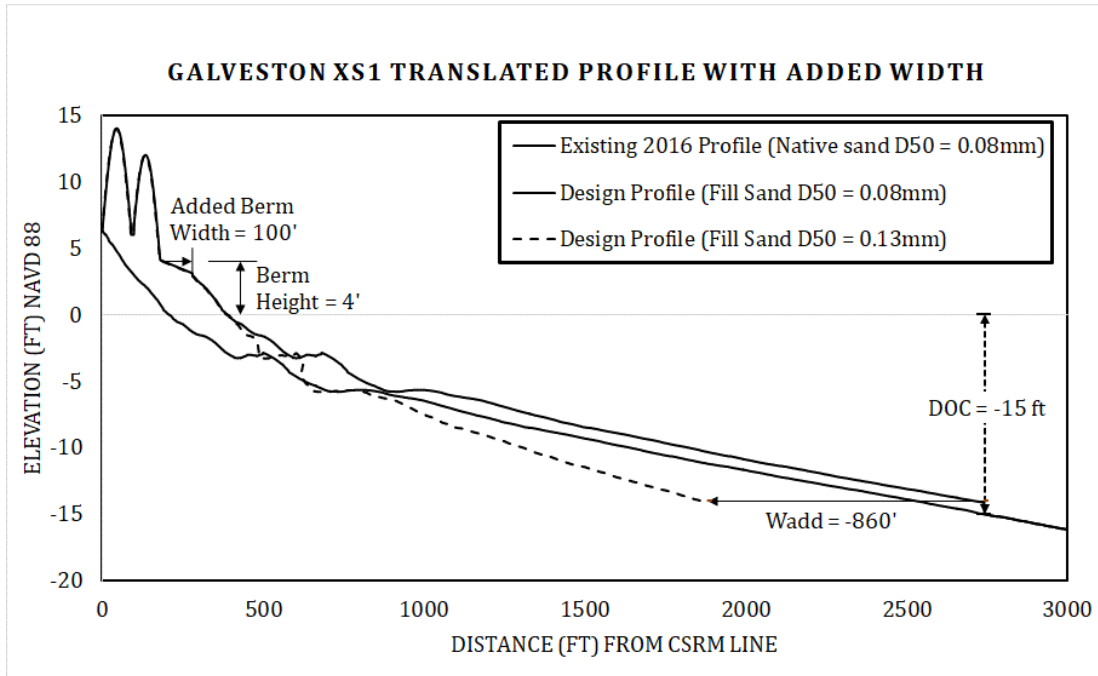

Figure 5-5: Galveston XS1 beach equilibrium profiles with theoretically derived d50 versus reported average

The theoretical profile associated with the 0.13mm grain size maintains roughly the same slope as the beach and intersects the existing profile due to a negative added width value associated with the sediment parameters. This results in a net reduction at approximately 40% in overall volume of design fill required for all profiles if the added width concept is applied.

Due to incomplete information regarding both native and borrow fill sediment composition, the added width is not applied to the design profiles in favor of a more conservative estimate that assumes borrow fill is equivalent to native fill. Conservatism in the estimate is intended to offset the sediment deficit in the pre-project beach profile, which is not accounted for with beach equilibrium profile concepts.

5.2 TENTATIVE DESIGN

Optimization trial simulations are used to review and compare profile configurations with combinations of the physical parameters outlined previously. A semi-qualitative approach is used to assess profile performance relative to volume requirements in initial trials. Initial trials intuitively indicate that (1) during severe storm surge events the max profile elevation is key to reduction of overtopping and ensuing dune failure, and (2) during more frequent storm events the berm width is key to reducing runup and dune toe scour.

5.2.1 **Berm**

Increased dune elevation had the most notable performance impact during Hurricane Ike simulations, while berm elevation and width-controlled impact to the toe of the dune during other storm simulations. Results from initial profile simulations suggest that the berm width has negligible influence on profile performance during extreme storm surge events such as Hurricane Ike. The berm is quickly inundated and provides minimal protection against incoming waves to the rapidly eroded dune. The dune fails quickly once overtopping begins, leaving the upland area exposed to storm surge and direct wave impact. However, the berm width does impact profile performance during lower magnitude storm surge events such as Frances, Rita and Allison. Significant scour is observed at the toe of the dune during these simulations with berm widths less than 60-feet. Further, the 200' berm width and 6' berm elevations were deemed excessive for frequent storms and ineffective during severe storm surges. Ultimately, the 100' berm width with a 1:100 slope is selected. This provides an average dry beach width of 200-feet, which is commonly considered to be characteristic of a healthy beach. The sloping berm reduces volume requirements relative to the flat berm by approximately 25% (for the 100' wide berm) and offers the ancillary benefit of notably reduced beach scarping during simulations. The 1:100 slope tends to match existing conditions better than the 1:150 slope.

5.2.2 **Dune Foundation**

The hardened core option was reviewed to assess the benefit of a clay or stone core that forms the foundation of the dune. The idea is similar to that of Geotube (geotextile bags filled with sediment, grout, or concrete) dune cores, which have been employed in various spots throughout the study site with some success. The most appealing benefit offered by the hardened core alternative is durability relative to overlying sand. In concept, the core is essentially a last line of defense against a severe storm event capable of eroding the overlying sand layer, in which case the exposed core is intended to provide an erosion resistant wave break to dampen incoming waves. The core alternative may also provide an auxiliary benefit in potential cost savings on fill material, assuming that savings from an alternate material are able to offset construction costs. Simulations were run with multiple configurations of the core using the "hard-bottom" profile option in SBEACH, which operates under the assumption that the hard-bottom profile will not erode. This is an unrealistic assumption, however, as it is not possible to model cohesive sediment in SBEACH.

Model results show identical erosion trends to non-core options until the core is exposed. The hardened portion of the profile remains intact, increasing scour adjacent to the seaward toe, while reducing transmission of wave energy leeward of the core. The model results are considered unreliable and were abandoned for the purposes of this study. It may be worth further exploration of this alternative during the PED phase. However, the concept has already given rise to concerns regarding potential aesthetic and environmental impacts.

5.2.3 Dune Optimization

The goal of design optimization is to balance cost with storm-induced profile performance. The performance of the profile is primarily based on the magnitude and duration of profile inundation during extreme surge events, i.e. – flooding and wave transmission landward of the dune feature. Inundation is inextricably linked to the majority of damage and associated cost caused by tropical storms and hurricanes. Prevention or mitigation of inundation with proposed design profiles is not solely predicated on dune failure itself, but on when and how the dune fails. Dunes are soft coastal features that can continue to provide protection past failure due to the residual elevation. Ultimately the profile performance during extreme events, such as Hurricane Ike, is controlled by the size and shape of the dune system.

The numerical modeling software, SBEACH (Storm-Induced BEACH Change), is used to simulate the storm-induced cross-shore response to four historic storms (using NDBC buoy time-series data as input) for existing profiles and alternative configurations. A review of modeled post-storm profile changes informs decisions on design feasibility and provides the basis for sediment budget requirements. Table 5-2 summarizes quantitative benefits of the dune field system according to SBEACH results for maximum wave height, maximum water depth and duration of inundation landward of the CSRM line for the existing conditions profile, single dune profile, and dune field profile seen in Figure 5-6.

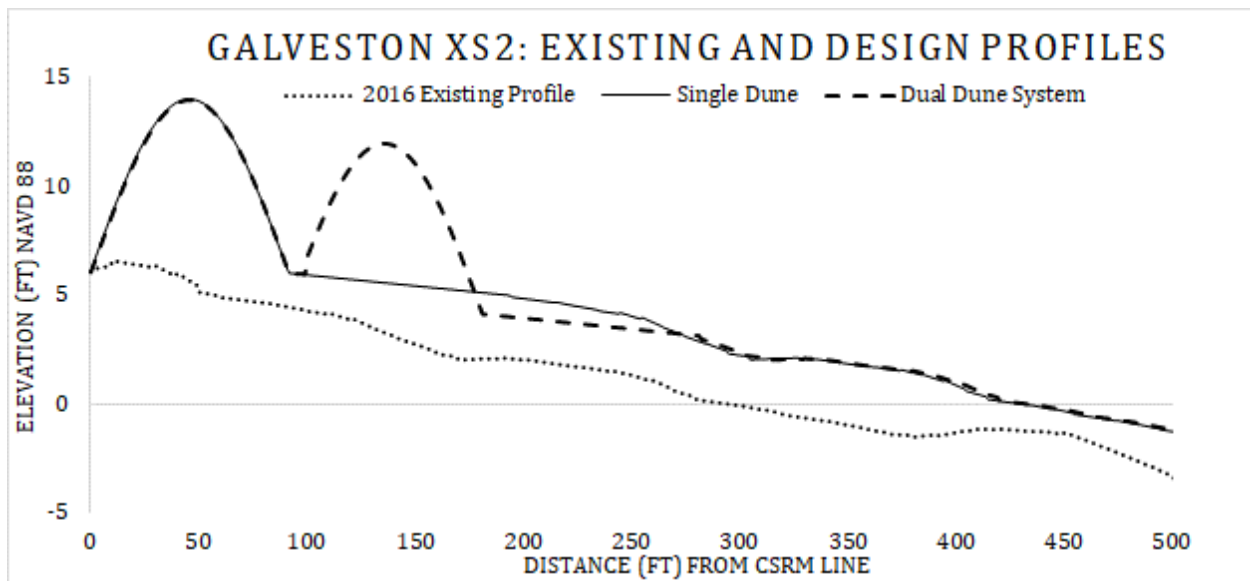

Figure 5-6: Galveston existing and design beach profile configurations

Figure 5-6 shows Galveston representative beach profile for single and dual dune profile configurations selected with a primary dune elevation at +14' NAVD88. The dune side slopes of the dune are set to 1:5 to accommodate environmental concerns regarding the ability of native species to traverse a steeper slope. The shallower slope increases the volume required for project construction by approximately

25% relative to the 1:3 slope at the low end of the recommended range, however the slope is similar to local dunes, and the added volume benefits dune performance as well.

The difference between the dune field system and the single dune is the addition of a foredune, with a crest elevation at +12' NAVD88 and the same 1:5 side slopes as the primary dune. Natural examples of this concept are prevalent on the east end of Galveston Island and in other healthy systems.



Figure 5-7: Natural Dual Dune Complex on the East End of Galveston Island (August 2019)

The primary benefit seen with the dune field system is preservation of the primary dune during storm simulations other than Hurricane Ike. Other simulations show some scour at the toe of the seaward foredune; however, the primary dune is preserved. The single dune system does not benefit from a foredune; thus, it is subjected to scour. The foredune serves a similar purpose to the berm in that it extends the life and integrity of the primary dune until it is needed for a more severe storm such as Ike. The volume required to construct the dual dune configuration is approximately 16% greater than the single dune configuration with the same primary dune dimensions. However, the perceived benefits appear to outweigh drawbacks according to SBEACH results. Table 5-2 summarizes SBEACH results for maximum wave height, maximum water depth and duration of inundation landward of the CSRM line for the existing conditions profile, single dune profile, and dune field profile as seen in Figure 5-6.

Table 5-2: SBEACH Output for Hurricane Ike - Inundation, Water Depth and Wave Height at the CSRSM line

Profile Configuration		Duration of Inundation (hours)	Max Water Depth at CSRSM (feet)	Max Wave Height at CSRSM (feet)
Existing Profile	Average	51.75	9.66	4.73
	Minimum	47.25	8.72	4.07
	Maximum	61.5	11.61	5.81
Single Dune Profile	Average	9.56	2.46	1.15
	Minimum	8.25	1.69	0.97
	Maximum	10.5	3.34	1.43
Dune Field Profile	Average	2.44	1.26	0.82
	Minimum	1.5	0.64	0.45
	Maximum	3.75	2.00	1.08

Results show a reduction in wave height at 76% for the single dune and 87% for the dune field relative to the existing profile. Similarly, the single dune reduces water depth by 74% and the dune field by 88%. The most significant reduction is in the duration of inundation, which is reduced by 82% with the single dune profile and 95% with the dune field configuration. The average duration and depth of inundation for the dune field configuration is just under 3 hours at 1.13 feet. It will require additional analysis to quantify the relative risk reduction, however the model results show a significant reduction to the hazard associated with surge events.

A single dune crest elevation of +17' NAVD88 is found to be the threshold elevation to equal the decreased inundation seen by the +14' dune field, however the associated volume increase is approximately 10% relative to the +14' dune field profile. Further, this assumes that the integrity of the single dune will not be degraded by less severe storms prior to an Ike-magnitude storm surge.

5.3 CSRSM TENTATIVELY SELECTED PLAN (TSP)

The tentatively selected plan (TSP) for the CSRSM study site is a dune field and sloping berm system. A 3D rendering included in Figure 5-8, depicting existing conditions and typical CSRSM design features. The graphic is not to scale, and dimensions vary relative to local shoreline conditions.

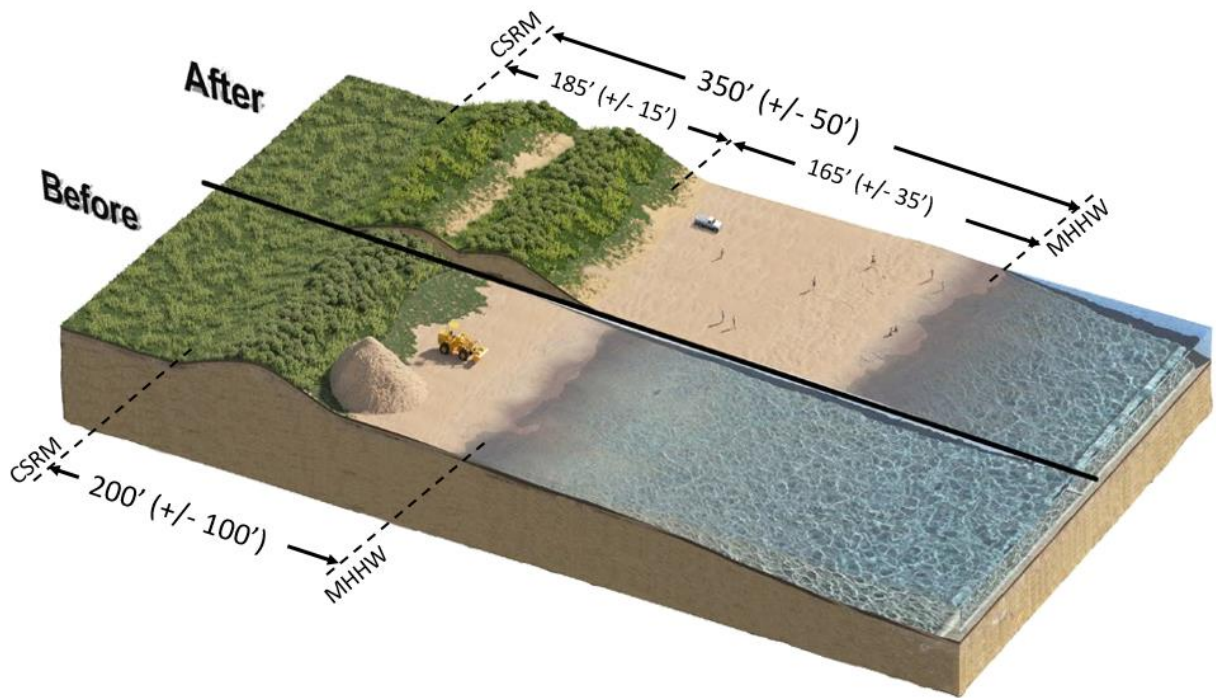

Figure 5-8: 3D Representation of existing profile and tentatively selected plan with general beach dimensions

The total construction volume feasibility estimate is provided in Table 5-3. The estimate is intended as an order-of-magnitude estimate, based on methodologies outlined in this report. Final estimates should be developed based on PED phase recommendations included in the conclusion of this report.

Table 5-3: CSR Construction Volume Estimate

CSR Volume Estimates	West Galveston Island		Bolivar Peninsula		UNITS
	XS1	XS2	XS1	XS2	
Design Profile:	162.97	132.30	139.50	135.58	cyd/ft
+ Advanced Fill:	170.45	144.19	155.63	147.92	cyd/ft
Alongshore Distance:	11.94	6.41	13.10	11.99	miles
Subtotal:	10.75	4.880	10.77	9.36	M*cyd
+10%	11.82	5.368	11.85	10.3	M*cyd
Total:	17.19		22.14		M*cyd
Grand Total:	39.33				M*cyd

Figure 5-9 depicts a vertically exaggerated Bolivar Peninsula dune-beach design profile with typical dimensions and elevations of CSR features for the TSP. Dimensions such as the overall dune width are dependent on the leeward toe elevation and vary according to existing conditions.

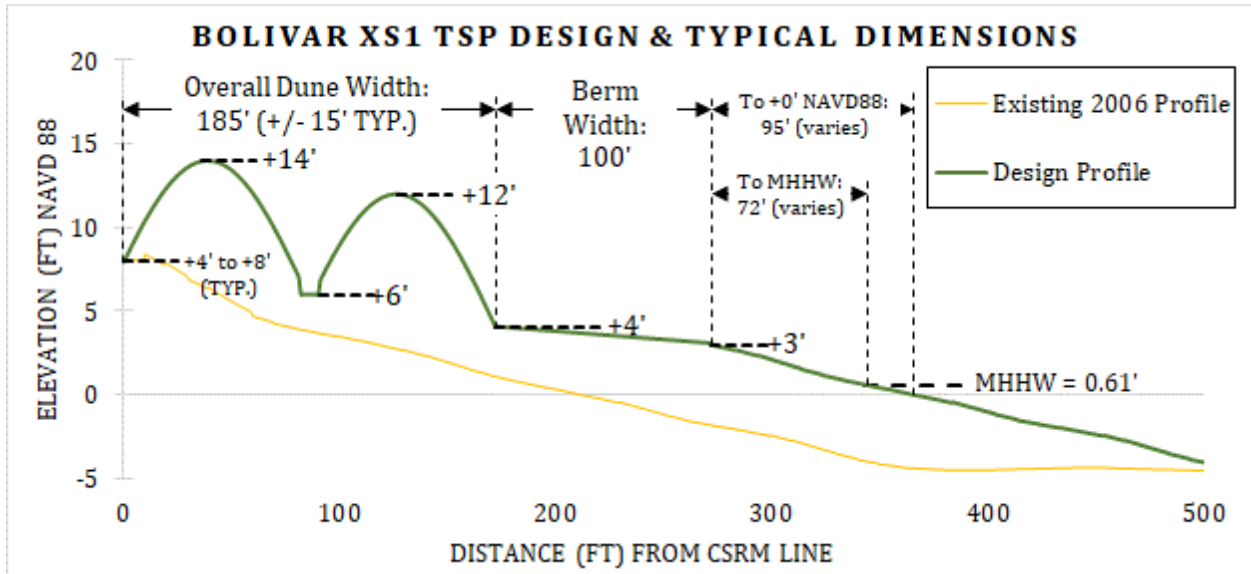

Figure 5-9: Typical dimensions and elevations for CSRM tentatively selected design profile represented on Bolivar XS1 representative profile; dune side slopes are 1:5

Construction templates extending to the depth of closure are included in Figures 5-10 through 5-13. Construction template profiles vary according to existing profile shape and estimated fill requirements. Construction template slope, top elevation and volume of advanced fill are included in captions.

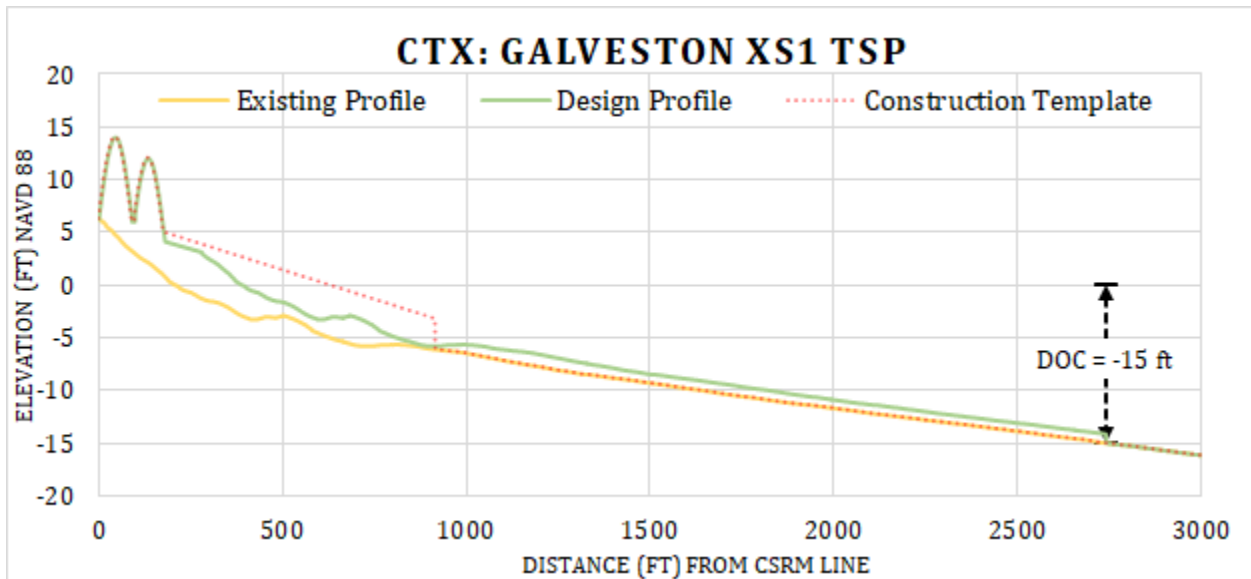

Figure 5-10: Galveston XS1 TSP; Construction template volume = 7.5 cyd/ft, top elev. at +5', slope at 1:90

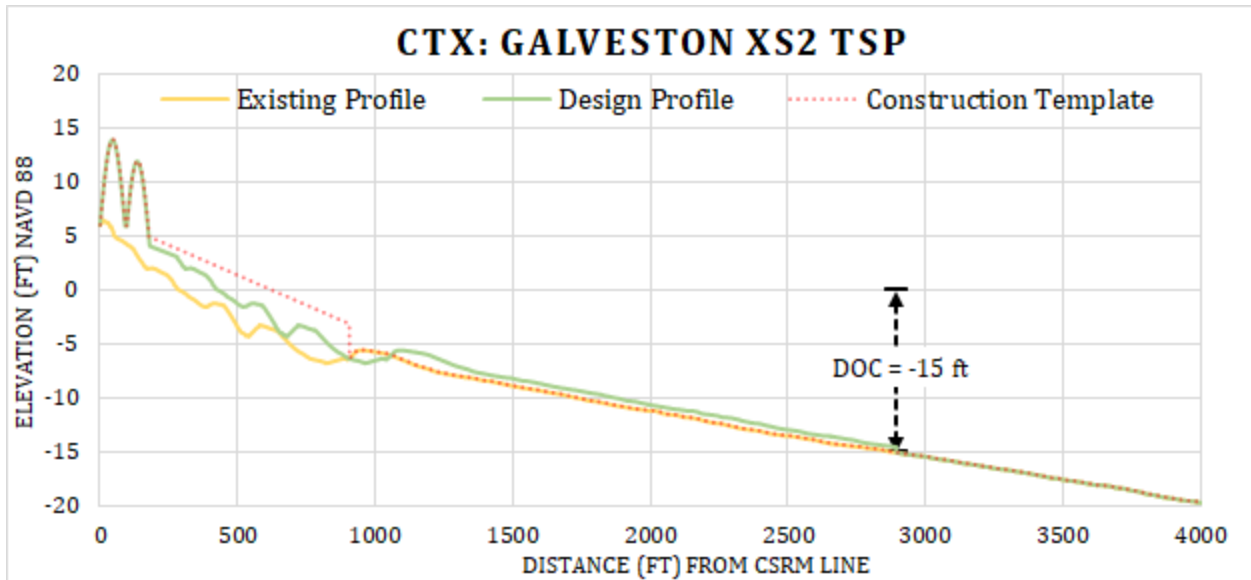

Figure 5-11: Galveston XS2 TSP; Construction template volume = 11.9 cyd/ft, top elev. at +5', slope at 1:90

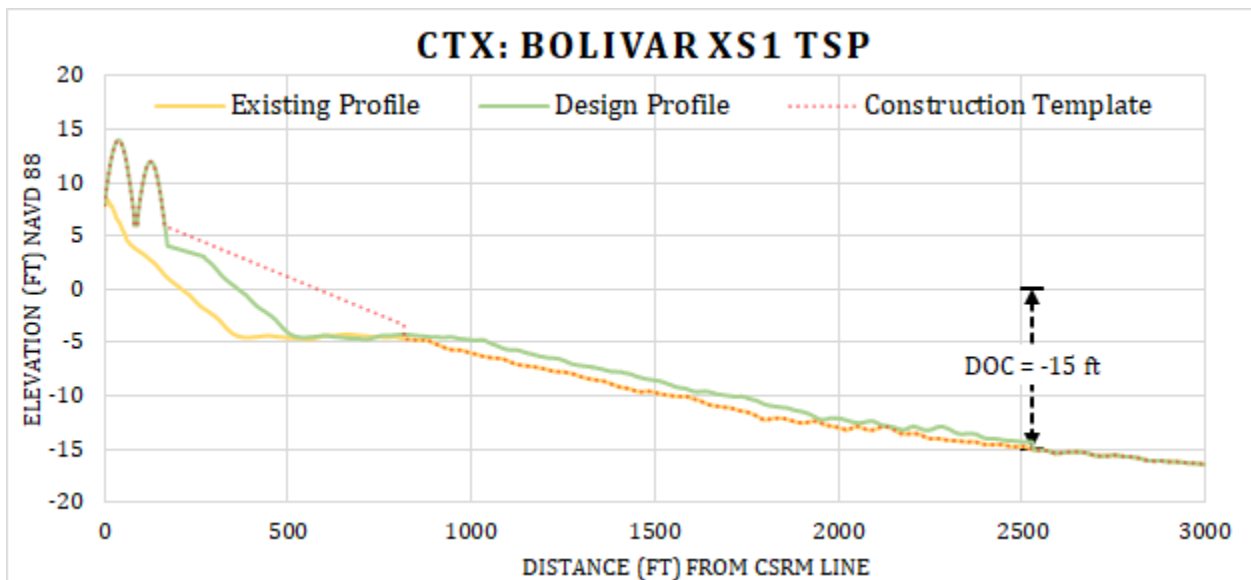

Figure 5-12: Bolivar XS1 TSP; Construction template volume = 16.1 cyd/ft, top elev. at +6', slope at 1:70

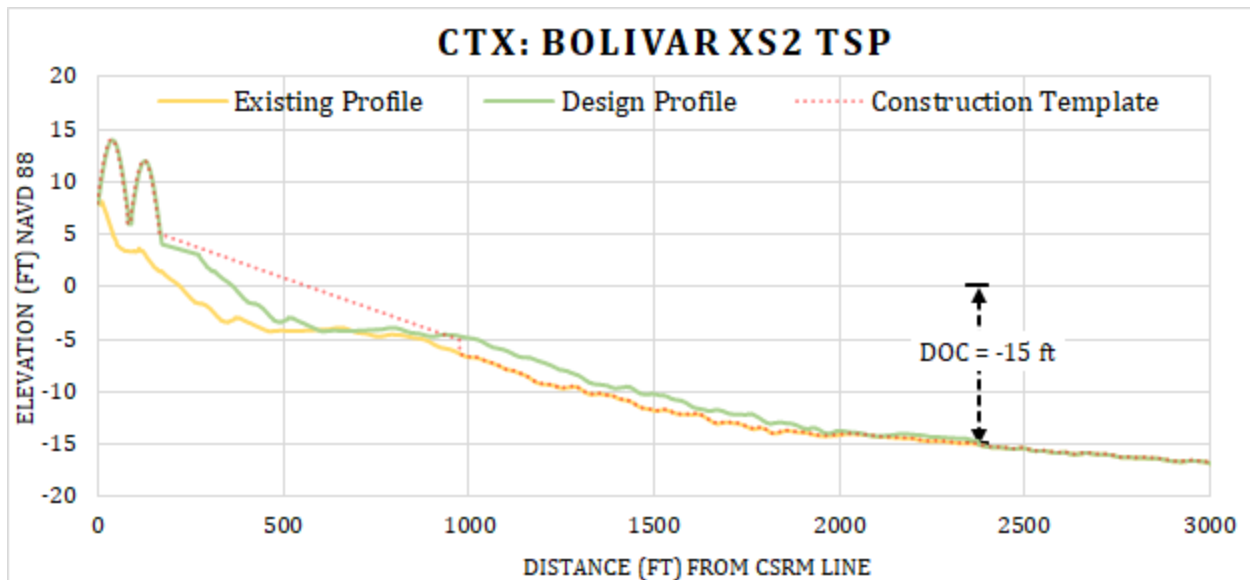

Figure 5-13: Bolivar XS2 TSP; Construction template volume = 12.4 cyd/ft, top elev. at +5', slope at 1:80

5.4 SEDIMENT SOURCE INVESTIGATION

A material source investigation was completed by Mott MacDonald in August 2018 and is included in Annex 10. The report considered sediment sources for all CSRM and ER measures. Sediment sourcing is a significant consideration for this study but is most significant for the beach and dune systems along the upper coast considering the total quantity required. The Mott MacDonald report builds on substantial work done by Freese and Nichols (2016) in cataloging sediment sources along the Texas coast.

Sabine and Heald Banks are considered a feasible source of beach-quality sand for the Bolivar and Galveston beach and dune systems. These deposits contain potentially 1.8 billion CY of sand considered compatible with the beach nourishment projects on the upper Texas coast. Despite the large total volume available, there will be avoidance areas that need to be considered (e.g., offshore platforms, pipelines, etc.). Three will also need to be additional geotechnical and geophysical investigations during PED to better constrain locations with the most ideal sediment sources.

The Sabine and Heald Banks are the sediment sources used for the feasibility phase of this project given they are the most conservative approach. There are other potential sources that needs to be evaluated during PED. These include shoreface sediment, dredging associated with the HSC deepening/widening project, measures complementary to navigation projects, and other paleo-channel deposits. Although costs are calculated based on Sabine and Heald Banks source, it is recommended that cost effective near shore source be investigated in PED by leveraging on going and future related studies.

5.5 **BEACH DRAINAGE**

5.5.1 **West Galveston**

The Galveston Island beach drainage study efforts focus on the region west of the seawall, including Jamaica Beach, at locations where proposed dune and beach nourishment features overlap with existing drainage flow paths that discharge stormwater runoff onto the beach. The objective of the study seeks to reroute beach discharge through the dunes via culvert(s) while maintaining the same general footprint and flow pattern. The concept is intended to provide a minimal-impact solution, designed to match or improve existing drainage conditions, while simultaneously mitigating adverse impacts to the contiguous dune system. Details of the study can be found in Annex 18.

The verbiage within Federal, State, County, and Municipal beach drainage regulations are generally oriented towards protection of the dunes and beach, which aligns well with the spirit of the proposed project. The most restrictive language is found in Municipal Ordinance 84-40, passed by the City of Galveston in 1984, which states that "... no drainage will be permitted into the Gulf of Mexico or onto the adjacent beach." The City drainage plan clarifies that preexisting developments with beach drainage are exempt under a "grandfather clause".

A hydrologic and hydraulic analysis is performed to develop culvert size/location design recommendations for eleven drainage basins based on a 100-year (1% annual exceedance probability) design storm. This solution offers a simplistic and presumably low-cost approach, although alternatives have not yet been explored in depth. A preferable, but potentially costly, alternative is to route all stormwater runoff to bayside outfalls. This alternative may require significant construction efforts due to topographic challenges, however it would alleviate maintenance challenges associated with the dynamic nature of the beach, while working harmoniously with other CSRMs during storm surge events. Alternatives should be reviewed for cost, risk and benefit in next phases of design. Proposed drainage features are documented in Annex 18.

5.5.2 **Bolivar Peninsula**

The Bolivar Peninsula beach drainage study efforts span from wetlands near Fort Travis to residentially developed Crystal Beach area. Drainage on the low-lying peninsula is conveyed to six open-channel beachside outfalls via a system of sloughs, drainage ditches, and open-channels. The sloughs and many of the drainage ditches hold water during typical conditions due to topographic challenges and sedimentation of the channels. Beach discharge has created large breaches in the dunes at outfall locations. The objective of the study seeks to route existing beach discharge through proposed dune features via culvert(s) while maintaining the same general footprint and flow pattern. The concept is intended to provide a minimal-impact solution, designed to match or improve existing drainage conditions, while simultaneously mitigating adverse impacts to the contiguous dune/levee system. Details of the study can be found in Annex 18. State and county effective beach drainage regulations

for the Bolivar Peninsula study area are outlined in the Galveston County Dune Protection and Beach Access Plan (2006), which is generally intended to provide protections to beach and dune systems. There are provisions within the protection plan that offer allowable mitigation measures to offset adverse impacts of beach drainage, which align with the nature of the beach nourishment and dune construction project.

Bolivar Peninsula beach drainage is relatively extensive in comparison to Galveston Island. Topographic challenges and relatively large drainage basins limit the region to a maximum level of service equivalent to 5-years, according to the Galveston County Master Drainage Plan (2012), which assumes the existing gravity drainage system is optimized and maintained. The hydrologic and hydraulic analyses, and subsequent recommendations on culvert size/location are therefore based on a 5-year design storm. The only exception is the largest and westernmost drainage basin that drains to Beacon Bayou. This basin is bisected by the proposed levee alignment, which separates the residential area from Beacon Bayou, affording the interior region an increased level of service at 25-years. To maintain existing flow paths, drainage is routed through the levee as opposed to the dunes at this location, where it outfalls into the adjacent wetland. Proposed drainage features are documented in Annex 18.

6.0 STRUCTURAL DESIGN

6.1 SCOPE

This section outlines the structural data gathering efforts and the engineering analysis performed for the Coastal Texas FIFR-EIS. A feasibility level analysis was completed on the features that generally are the cost drivers of CRSM projects. The analysis performed was sufficient to allow the development of quantities required to develop a cost estimate for the project. Refer to the Hydrology and Hydraulic section (Section 2.0) for a discussion on the development of project element design elevations.

All of the features described in this chapter are located in Region 1 (Figure 6-1), which in turn can be broken into three separable geographic regions: the Western Perimeter Costal Storm Risk Management (CSRM) of Galveston Bay, Bolivar Road Complex CSRM Crossing and Galveston Island Perimeter CSRM.

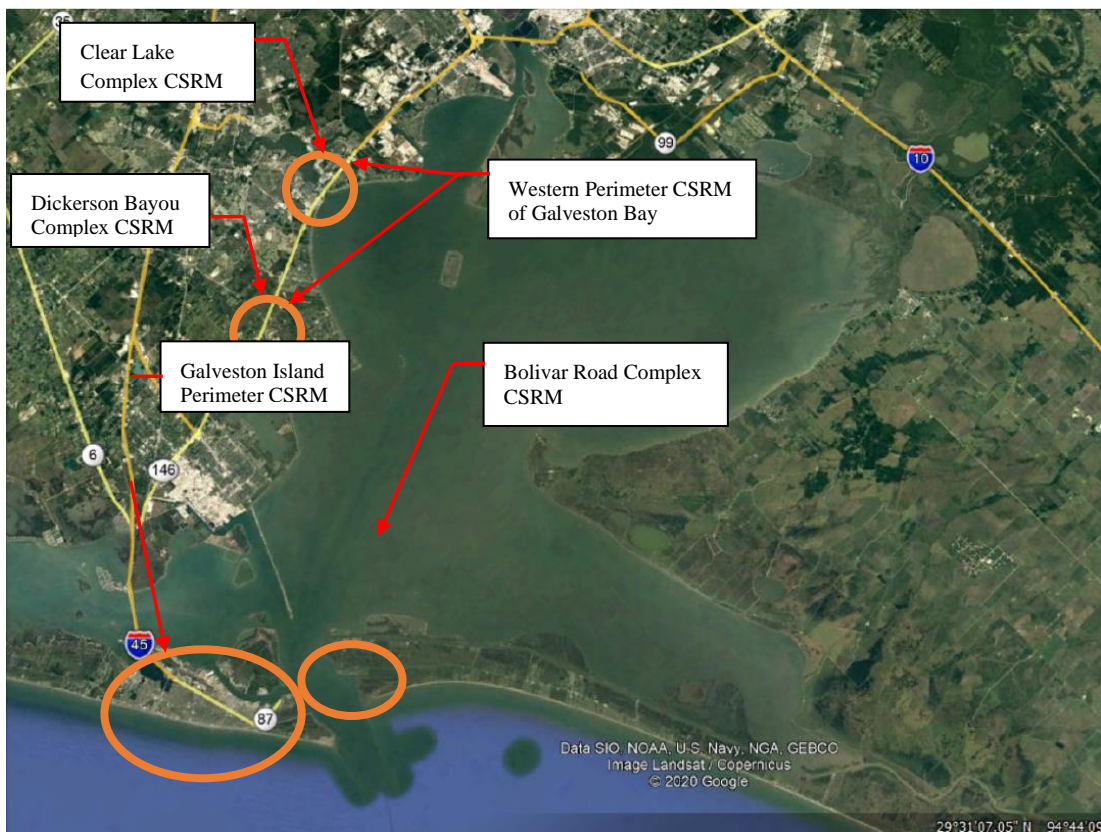

Figure 6-1: Overall Structural Feature Map

The work along the Western Perimeter CSRM of Galveston Bay was completed by Mott MacDonald Company as a contractor for the local sponsor, the Texas General Land Office (GLO). Mott MacDonald's effort can be found in separate reports (Annex 7 & 8). The Bolivar Roads Complex

CSRM and the Galveston Island Perimeter CSRM was completed by the USACE and is presented in the following sections of this chapter. Preliminary design drawings can be found in Annex 19.

6.2 ANALYSIS/DESIGN

All analysis performed to support the quantities used to develop the project cost estimate assumed a top of system flood side water surface elevation with a water surface elevation of +0.0 on the landside of the structure assuming a pervious uplift condition. Foundation pile tips are selected based on a factor of safety of 2.0 assuming a pile load program. The pile load test allows a factor of safety of 2.0 to be used in the selection of pile tip elevation. The analysis performed assumed a pervious uplift pressures, however, a 40' long continuous steel sheet pile cut-off wall is included for all of the structures (except the combi-wall, the cylinder piles and closure piles to provide the seepage cut-off). Both pervious and impervious uplift will be further investigated in future.

Open ended steel pipe piles were assumed for the foundation piles because steel piles can be spliced to produce any pile length required. Steel pipe piles were chosen in lieu of H-piles because of the symmetric properties of a pipe pile and the potential for end bearing capacity being developed from a pipe pile if a sufficient plug is created. A detailed investigation of the pile type and size needs to be performed during PED. Pile efficiency, pile cost, availability and the effects on the ecosystem will be factors in the decision making of the final pile type and size during PED.

The feasibility design does not include an unbalanced load, or a settlement induced bending moments (SIBM) in the analysis. SIBM's were not included because we are not adding significant amounts of new fill in the vicinity of the structures. Also, the foundation width of these large structures is generally wide enough such that global stability is not a concern. Both of these items will be investigated in detail during future structural and geotechnical design.

A seismic analysis was not performed during feasibility. According to ER 1110-2-1806, the project is located within a low seismic hazard region. In general, seismic analysis does not govern the design of these types of structures within the low seismic hazard region. During PED a response spectrum analysis will be performed for each structure as part of the detailed design.

The natural ground elevation assumed for the structural analysis was established from existing LiDAR survey data for structures constructed on land. The bottom elevation for the Bolivar roads and Offatts Bayou crossing were taken from the hydraulic models used for this study.

The table below lists the project features for the Bolivar Roads crossing. The table indicates what features were sized based on preliminary analysis and what features were assumed.

Table 6-1: Bolivar Roads Project Features

Gate Type	Feature Analyzed	Features Assumed
-----------	------------------	------------------

Shallow Water Environmental Gate	Pile Foundation, Sluice Gates, Access Bridge Grating, Required Temporary features required for construction	All Concrete features, Required Seepage cut-off depth
Vertical Lift Gates	Pile Foundation for Towers, Pile Foundation for Sill, Access Bridge Beams Main members of the Gate, Required Temporary features required for construction	All Concrete features, Required Seepage cut-off depth
Recreational Navigation Sector Gate	Pile Foundation Main members of the Gate, Required Temporary features required for construction	All Concrete features, Required Seepage cut-off depth, Guidewalls
Floating Sector Gate	Pile Foundation, Pile Foundation for Sill, Main members of the Gate, Required cofferdams that make up the perimeter of the island Dry Dock	All Concrete features, Guidewalls Island Fill
Combi-Walls	Steel Batter Support Piles Cylinder piles	All other features

The analysis listed in the above table is a result of seamless communication between PDT members. During the study phase the structural engineer relied on both the Geotechnical and Hydraulic engineer for critical design information. Hydraulics provided (Section 2.0) the top-of-wall elevations for all structural features and the bathymetric data for the crossing at Bolivar Roads. The geotechnical engineer provided pile capacity curves for each structure as well as the temporary cofferdam loading and required sheet pile tip. The structural designer provided required cut-elevations for the geotechnical analysis.

6.3 BOLIVAR ROAD SURGE BARRIER SYSTEM

6.3.1 Gate Selection

The local sponsor’s consultant’s report “Gulf Coast Community Protection and Recovery District (GCCPRD) Storm Surge Suppression Study, Phase 2 Report, March 23, 2016” was leveraged to quantify and compare plans using the structures detailed in the report. For the gate selection, international experts from around the world were invited to Galveston, Texas including members from the International Network for Storm Surge Barriers (I-STORM) to conduct a gate design collaborative workshop held during 17 to 19 March 2019. All discussions / views expressed at the workshop were those of I-STORM not of individual companies that individuals may represent. Background materials were provided electronically to attendees before the event to help focus in-person discussions on reaching consensus rather than spending valuable time on learning background information. The main event was held 18-19 March and consisted of the following major tasks (Annex 15)

- i. Introduction, debate and finalization of ranking criteria.

- ii. Breakout group brainstorming multiple options for closure structures. The structures were subdivided by draft and navigability requirements into 3 sections; shallow, intermediate, and deep.
- iii. Presentation of closure structure options by the breakout groups to the larger team for debate.
- iv. Re-assessment of ranking criteria to incorporate lessons learned during the brainstorming sessions.
- v. Individual ranking of all provided options.
- vi. Summarization and presentation of ranking results followed by debate and consensus around understanding.
- vii. A short 20-minute breakout into the original groups to combine the highest ranked gate designs into comprehensive closure systems.
- viii. Presentation and discussion of the recommended closure structures.

The teams identified 10 to 20 structure types for each section and screened those down to a total of 18 closure types for the larger team to rank. The following tables show the raw data resulting from the ranking exercise averaged by all participants (Table 6-2), I-STORM invited members only (Table 6-3). The ranked structure types, identified by numbers along the top of the second row in Table 6-2 and 6-3, are listed following the Tables. In these tables, each selection criteria and constraints are evaluated on a scale of 0 to 5 where 5 represents the most suitable gate type. A larger view of this data can be found in Annex 15.

Table 6-2: Raw scores averaged across all participants.

Criteria	Shallow Draft							Intermediate Draft							Deep Draft				
	1	2	3	4	5	6	7	8	11	12	13	14	15	21	22	23	24	25	
a	Blockage Ratio	3.3	3.9	4.1	3.7	3.1	3.3	4.7	3.7	3.3	3.3	3.0	2.2	4.6	1.6	3.3	5.0	5.0	3.5
b	Time to open and close	4.3	4.0	3.7	4.5	4.2	2.0	2.6	3.0	4.5	4.3	4.2	3.8	3.9	3.5	4.2	4.2	4.0	4.0
c	Alignment	3.8	3.7	4.0	3.7	3.4	3.4	3.5	3.2	3.7	3.8	3.0	3.4	4.2	3.7	3.4	4.3	4.4	3.6
d	Cost	3.1	2.8	3.5	2.6	4.4	3.2	2.9	2.1	3.4	2.9	2.9	2.4	2.6	2.9	2.7	2.2	2.0	2.1
e	Operation and Maintenance Cost	3.7	2.4	3.1	2.4	4.2	2.5	2.4	2.2	3.9	2.9	3.4	3.1	1.9	4.2	3.0	1.4	1.5	2.1
f	Reliability and Redundancy	4.7	3.5	3.4	3.2	4.7	2.0	1.6	1.1	4.7	4.4	4.2	4.2	2.6	4.6	4.2	2.0	1.6	2.7
g	Adaptability	3.7	2.7	2.2	2.3	2.7	2.7	2.7	1.5	3.8	3.6	2.6	2.7	2.2	3.0	3.2	1.6	1.8	2.3
h	Constructability	4.0	3.5	3.4	3.1	4.2	3.3	2.8	2.1	3.8	3.5	3.1	3.3	2.9	3.4	3.2	2.5	1.7	2.0
i	Technology	4.7	3.7	3.6	3.5	4.5	3.2	1.8	1.1	4.6	4.2	4.0	4.0	2.9	4.5	3.3	2.7	1.3	2.5
j	Impact	3.1	3.3	3.3	3.9	2.5	3.1	3.3	2.7	3.1	3.3	2.9	2.6	3.8	2.2	3.1	3.6	3.6	2.9
k	Additional Benefits (Bonus)	2.5	2.0	1.6	2.0	2.8	1.2	1.6	1.3	2.6	2.0	1.9	1.8	1.8	1.6	1.8	2.0	1.9	1.8
	SUM	41.0	35.4	36.0	34.9	40.9	29.7	29.8	24.1	41.4	38.1	35.1	33.3	33.2	35.3	35.5	31.5	28.6	29.5

Table 6-3: Raw scores averaged across I-STORM member participants.

Criteria	Shallow Draft								Intermediate Draft					Deep Draft					
	1	2	3	4	5	6	7	8	11	12	13	14	15	21	22	23	24	25	
a	Blockage Ratio	3.5	3.6	4.2	3.5	3.2	3.6	4.2	3.7	3.5	3.2	2.9	2.4	4.3	1.4	3.2	5.0	4.9	3.6
b	Time to open and close	4.5	4.0	3.9	5.6	4.1	1.7	2.4	3.3	4.5	4.6	4.5	4.1	4.3	3.4	4.4	4.4	3.7	4.2
c	Alignment	4.2	4.1	4.4	4.3	3.4	3.8	3.9	3.8	3.9	4.3	3.0	3.6	4.5	3.8	3.5	4.4	4.4	3.8
d	Cost	3.2	3.0	3.4	2.7	4.6	3.1	3.0	2.5	3.6	2.9	3.0	2.2	2.6	2.9	2.9	2.4	1.6	1.9
e	Operation and Maintenance Cost	3.7	2.5	3.3	2.6	4.5	2.6	2.1	2.3	4.2	3.1	3.8	2.8	1.9	4.3	3.4	1.5	1.1	1.9
f	Reliability and Redundancy	4.9	3.4	3.6	3.1	4.9	1.8	1.1	1.4	4.6	4.5	4.3	3.9	3.1	4.6	4.2	2.2	0.8	2.5
g	Adaptability	3.7	2.8	2.4	2.4	2.6	2.5	2.3	1.6	3.7	3.8	2.8	3.1	2.4	3.0	3.5	1.4	1.6	2.0
h	Constructability	3.9	3.8	3.4	2.9	4.2	3.4	2.7	2.2	3.9	3.5	3.2	3.2	2.9	3.4	3.2	2.6	1.1	1.4
i	Technology	4.9	4.1	4.1	3.8	4.4	2.9	1.8	1.3	4.9	4.5	4.2	3.9	3.4	4.8	3.8	2.9	1.0	2.3
j	Impact	3.2	3.2	3.6	3.4	2.8	3.2	3.1	3.0	3.4	3.4	3.1	2.9	3.6	2.6	3.3	3.4	3.0	2.8
k	Additional Benefits (Bonus)	2.4	1.8	1.4	1.8	2.7	1.1	1.1	1.4	2.6	1.7	2.0	1.9	1.4	1.5	1.4	1.4	1.2	1.5
	SUM	42.3	36.3	37.8	36.1	41.6	29.7	27.7	26.6	42.9	39.5	36.8	33.9	34.4	35.6	36.7	31.5	24.3	28.0

The numbers shown across the second row in Tables 6-2 and 6-3 relate to the following closure types:

Shallow water closures:

1. Vertical lift gate
2. Crest gate
3. Bladder gate
4. Vertical rising gate
5. Box culvert (precast)
6. Swinging barge gate
7. Railroad gate
8. Texas armadillo

Intermediate closures:

11. Vertical lift gate
12. Rising sector gate
13. Tainter gate
14. Sector gate
15. Flap gate

Deep water closures:

21. Floating sector gate
22. Rising sector gate
23. Flap gate
24. Piston gate
25. Vertical drop gate

The data in Tables 6-2 and 6-3 were presented to the entire group for discussion. From visual observation of the raw data, some structure types for each section clearly ranked higher (Greenish color) which are listed below. Interestingly, these same structure types ranked highest regardless of the overall group considered.

- Shallow Draft Section
 - Vertical lift gate
 - Precast Box culvert
- Intermediate Draft Section
 - Vertical lift gate
 - Rising sector gate
- Deep Draft Section
 - Floating sector gate
 - Rising sector gate

The breakout groups reconvened to consider and recommend comprehensive closure systems using the highest ranked structure types, listed above. Figure 6-2 below shows the recommendations of the Deep Draft Section. All three were similar, recommending box culverts in the shallowest section with vertical lift gates in the intermediate sections, and either rising or floating sector gates for navigation access.

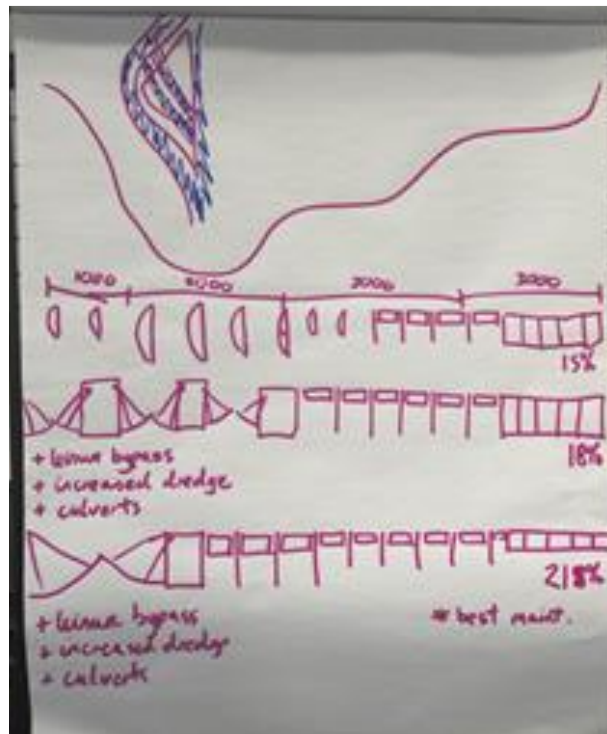

Figure 6-2: Recommended Closure Systems (Deep Draft Group)

The gate selection process has been documented in a decision document which can be found in Annex 15. The combination of features for the Coastal Storm Risk Measures (CSRM) spanning between Bolivar Island and Galveston Island were carefully chosen to both reduce environmental impacts to Galveston Bay and provide a system comprising of structures that have been proven to be reliable and implemented in similar environments and applications around the world.

Maintaining the maximum amount of the existing tidal circulation was paramount in selecting the number and combination of structures used to create the Bolivar Road’s crossing. The results from the extensive modeling of the Galveston Bay Ecosystem determined a blockage (percentage difference between existing or without project Bolivar Inlet cross section and with project inlet cross section) less the 10% what is required to maintain a thriving ecosystem within the Galveston Bay.

Table 6-4 below shows the combination of gate type, number and associated gate elevations that limit the blockage to less the 10%. Bolivar Roads crossing also consist of 5300 linear feet of combi-wall. This wall is similar to the wall constructed in Eastern New Orleans after Katrina as part of the Lake Borne Barrier.

Table 6-4: Gate Selection Overview

Gate Type	Sill Elevation	Gate Width	# of gates
Shallow Water Environmental Gate	EL. -5.0	16 ft x 16 ft *	16 gated monoliths*
Vertical Lift Gate	El. -20.0	300 ft	8
Vertical Lift Gate	El. -40.0	300 ft	7
Recreational Navigation Sector Gate	El. -40.0	125 ft	2
Floating Sector Gate	El. -60.0	650 ft	2
*each gate monolith has six (6) – 16’x16’ sluice gates			

6.3.2 Bolivar Road Crossing Features

Figure 6-3, below, shows the project features that consist of the Bolivar Road crossing (see Figure 6-1 for an overall structural vicinity map). Figure 6-4, below, is an artistic rendering of the Bolivar Road crossing. A description of each project feature shown in Figure 6-3 is provided in the remaining sections of this report. All features that make up the Bolivar Road crossing are assumed to have structure elevation of +21.5 ft NAVD88. The location of the Floating Sector Gates shown here resulted from a preliminary ship simulation exercise. Details of the ship simulation can be found in Annex 14.

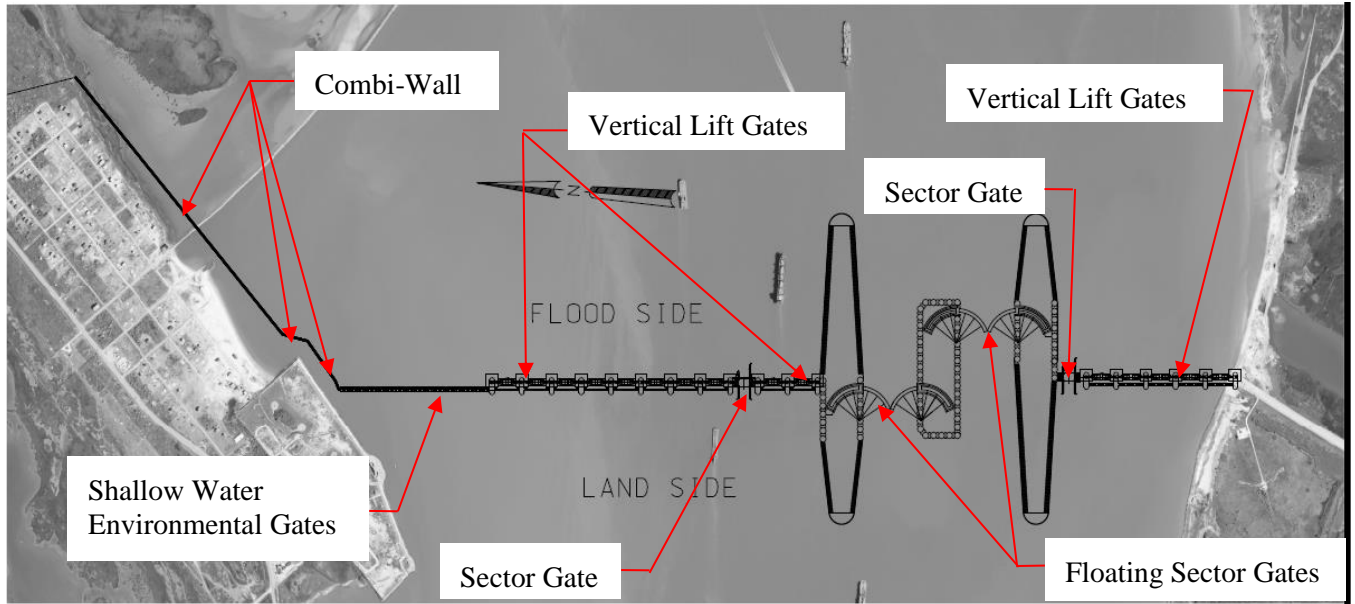

Figure 6-3: Bolivar Road Crossing CSRM features



Figure 6-4: Bolivar Road Crossing (Artist Rendition)

6.3.3 Combi-Wall

To construct a traditional inverted T-type flood wall within the Galveston Bay would require a cofferdam in order to construct the flood wall in the dry. A cofferdam would add both cost and additional temporary impacts to the Galveston Bay bottom. The proposed “Combi-wall” can be constructed in the wet with all the construction equipment located on a temporary platform, thus eliminating some of the bay bottom impacts and in more streamlined construction sequence. The

proposed “combi-wall” system consists of vertically driven 66 in diameter hollow concrete spun cast piles with 18 in closure piles closing driven to complete the closure of the system. The lateral resistance for this system comes from a 36-in Ø steel batter piles with a concrete deck sections that ties the system together with a small parapet wall. The concrete deck sections will serve as an access roadway for the entire length of the combi-wall. A blanket of scour will be placed on both the Flood and Land side of this structure to prevent erosion.

It is assumed the combi-wall will be constructed from a temporary work platform in order to minimize the impacts of dredging a floatation channel for access on the marine habitat in this area. A similar type floodwall was constructed as part of the New Orleans Hurricane Storm Damage Risk Management System, Lake Borne Barrier. The Lake Borne Barrier has performed as designed during several tropical events without any issues. Figure 6-6 shows a typical section of Combi-Wall.

The combi-wall is a continuous concrete barrier that does not allow tidal circulation. There are no moving parts or gates for this feature that would require deployment in advance of impending tropical event. Therefore, there is not a concern of this features reliability to deploy during an event.



Figure 6-5: Combi-wall (Conceptual Rendition)

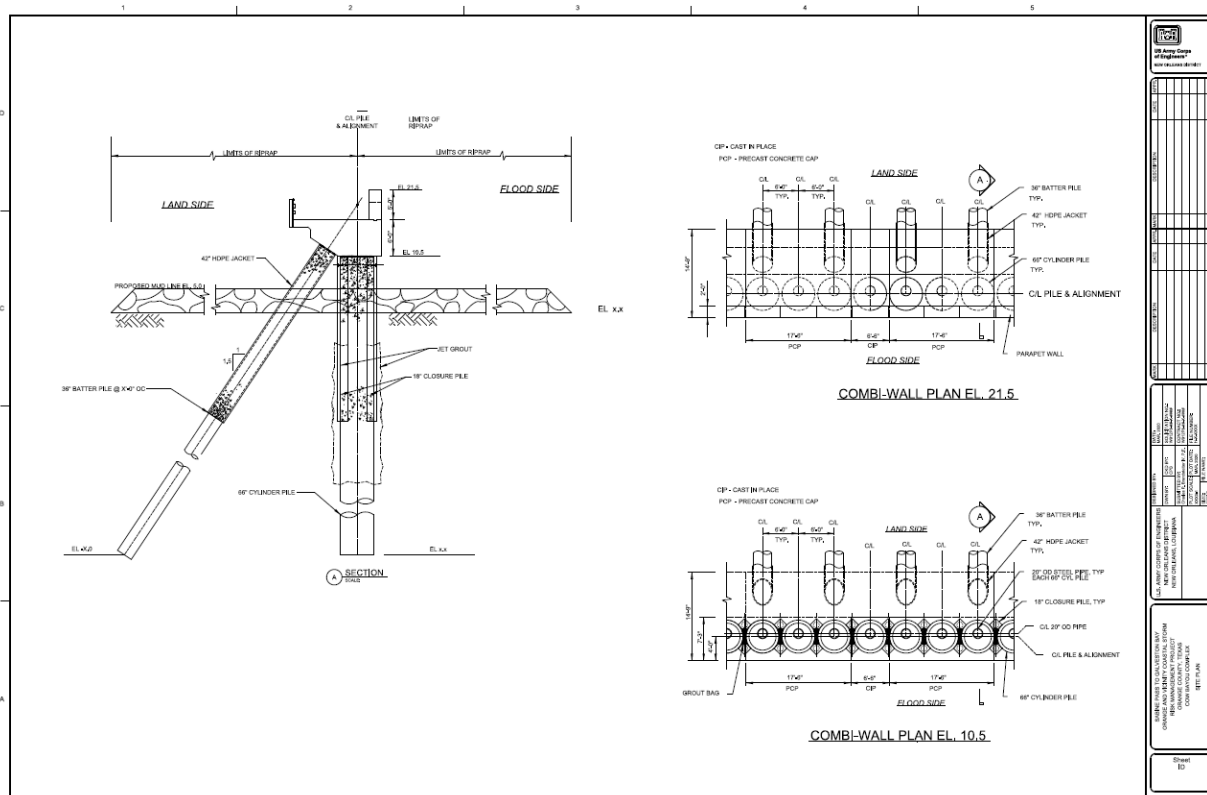

Figure 6-6: Combi-wall (Technical Drawing)

6.3.4 Vertical Lift Gates

The Vertical Lift Gates (VLGs) are proposed for the intermediate and deeper parts of the Bolivar Roads crossing. There are VLGs on both the Bolivar Island and the Galveston Island side of the barrier. There are eight (8) VLGs with a sill elevation of EL. -20.0 and seven (7) VLGs with a sill elevation of EL. -40.0. The feasibility level design assumed the gate will transfer all the lateral load to the piers which is founded on a large matt foundation supported on 24-in Ø pipe piles. There is a concrete sill set at the gate invert that spans between the tower foundations and is founded on a large matt foundation supported on 24-in Ø pipe piles. A blanket of scour will be placed on both the Flood and Land side of this structure to prevent erosion.

The VLGs are specifically designed to provide a large opening to allow for free passage of the tides for both sides of the gate. The VLGs will be stored in the up at normal/open position. The gates will remain in the up position until they are needed to be deployed for a tropical event. These gates have a low clearance between the bottom of the gates in the stored position and the normal water surface elevation in Galveston. Therefore, the VLGs are not intended for any type of navigation. The Bolivar Road crossing has other navigation features to address large vessels that typically use the Houston ship channel as well as recreational traffic. These features are discussed in this Section.

The vertical lift gates will have an access bridge on the land side of the structure to allow maintenance crews access to maintain the gates and operate equipment. The access bridge is assumed to span the entire gate opening by using large precast prestressed concrete highway girders with a concrete deck serving as the roadway on top.

The vertical lift gates are suspended between the structure's towers on either side of the opening. The lift gates and the towers of the barrier have a unique shape: the gates are elliptical, and the towers are oval. The vertical lift gates are driven by hydraulic cylinders with a long piston which are hinged to the side towers. The VLG's for the Bolivar Road crossing have a clear opening of 300 ft. Figure 6-7 shows a rendering of VLG and Figure 6-8 shows a typical section.

The VLGs are assumed to be constructed using conventional cast in place construction methods. A temporary retaining structure consisting of cellular cofferdams that are dewatered to facilitate the construction of the structure. The dredging of a floatation channel is required for marine access to the VLG with a sill elevation of -20.0. However, the VLGs with a sill elevation of -40.0 do not require the dredging of a floatation because the location of these structures already have adequate draft for the marine equipment required for construction. It was assumed these structures will be constructed using equipment set on a floating plant.

The Vertical lift gates assumed for this study are modeled after the Hartel Canal storm surge barrier located in Spijkenisse, Netherlands. The Hartel Canal floodgate has been in operation and has been reliable since construction completion 1996. In the event the closing operating system fails, these gates have a local, automatic closure system, battery controlled, using gravity to close the gate. Like the Hartel Gates, it is assumed any minor maintenance will be performed while the gates are in place. If there are substantial repairs, the gate or the gate machinery will be removed from the site and brought to a dry dock where the required maintenance can be performed.

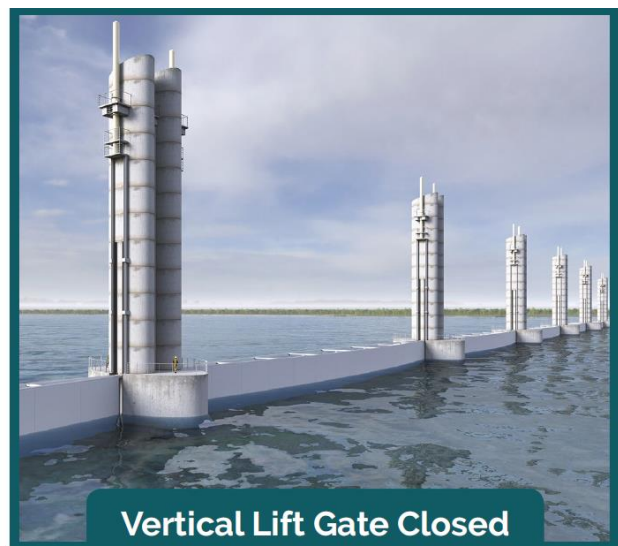
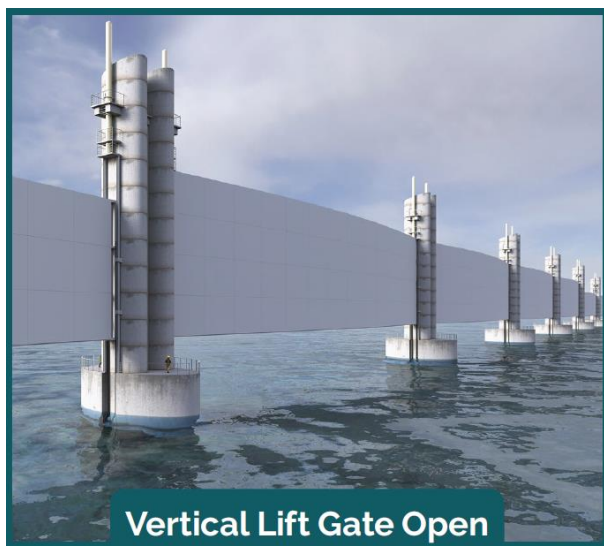

Figure 6-7: Vertical Lift Gates (VLGs) (Conceptual Rendition)

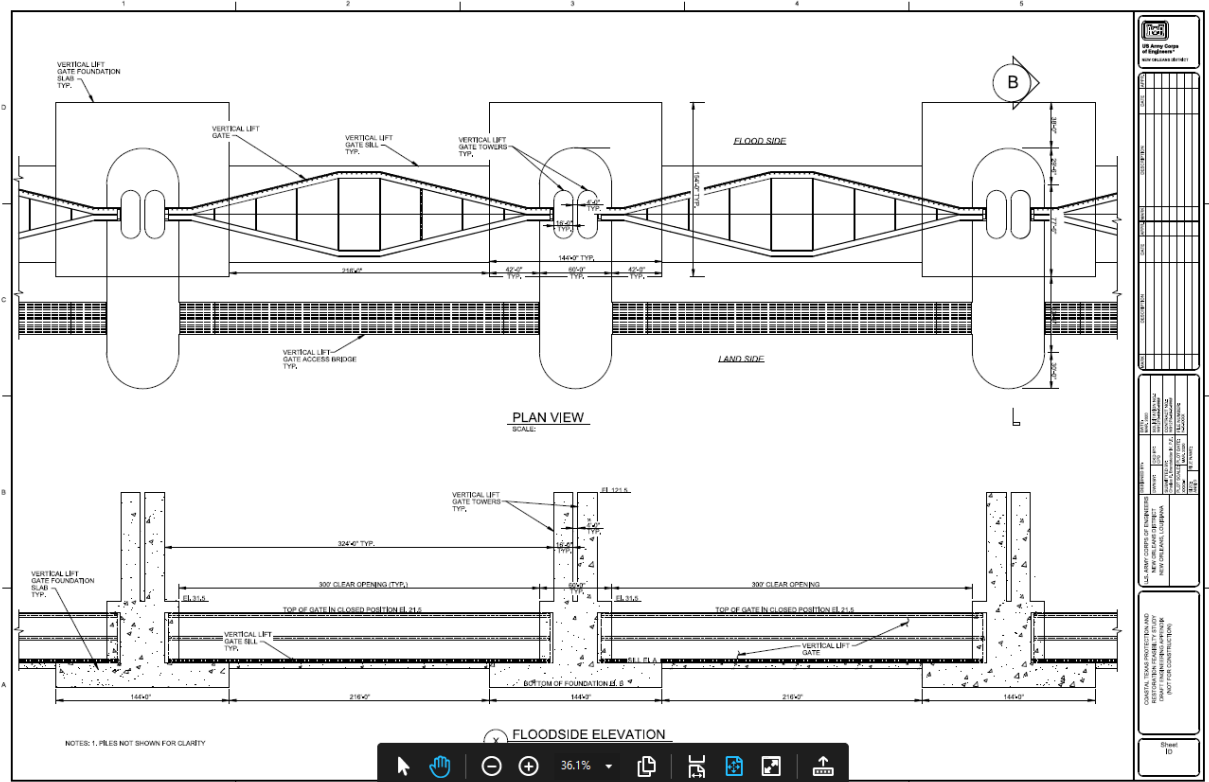

Figure 6-8: Vertical Lift Gates (VLGs) (Technical Drawing)

6.3.5 Shallow Water Environmental Gates (SWEG)

SWEGs are a barrier made up of multiple sixteen-foot by sixteen-foot automated stainless-steel sluice gates within a concrete tower. The sluice gates will be operated by a hydraulic or an actuated system that opens and closes the gates. Each gate will have a local system where the gate can be shut with a portable actuator in the event one of the gates will not close from a remote source.

The SWEG’s monoliths are proposed for the shallow portion of the Bolivar Roads crossing on the Bolivar Island side of the crossing. There are sixteen gated monoliths, each gated monolith will house six (6) automated stainless-steel sluice gates VLG’s with a sill elevation of EL. -5.0. The feasibility level design assumed the gate will transfer all the lateral load to the piers which is founded on a large matt foundation supported on 24-in Ø pipe piles. A blanket of scour will be placed on both the Flood and Land side of this structure to prevent erosion.

The gated monoliths provide multiple small opening to allow for tidal passage from both sides of the gate. These gates are stored within a concrete tower and are stored above the normal water elevation. The gated monoliths will have an access road on the land side of the structure to allow maintenance crews access to the gates and operating equipment. The road is assumed to consist of stainless-steel

industrial grating. The grating will allow light to pass through, which is imperative for the marine life in the shallow portion of the crossing.

The SWEG's assumed for this study are modeled after the Davis Pond and Caernarvon Freshwater Diversion Structures constructed within the greater New Orleans area. Both the Davis Pond and Caernarvon structures are part of the Mississippi River and Tributaries system. These gates are operated frequently to control the amount of freshwater allowed to pass thru the structures and have shown to be reliable for decades. Figure 6-9 shows a rendering of SWEG and Figure 6-10 shows a typical section.



Figure 6-9: Shallow Water Environmental Gates (SWEG) (Conceptual Rendition)

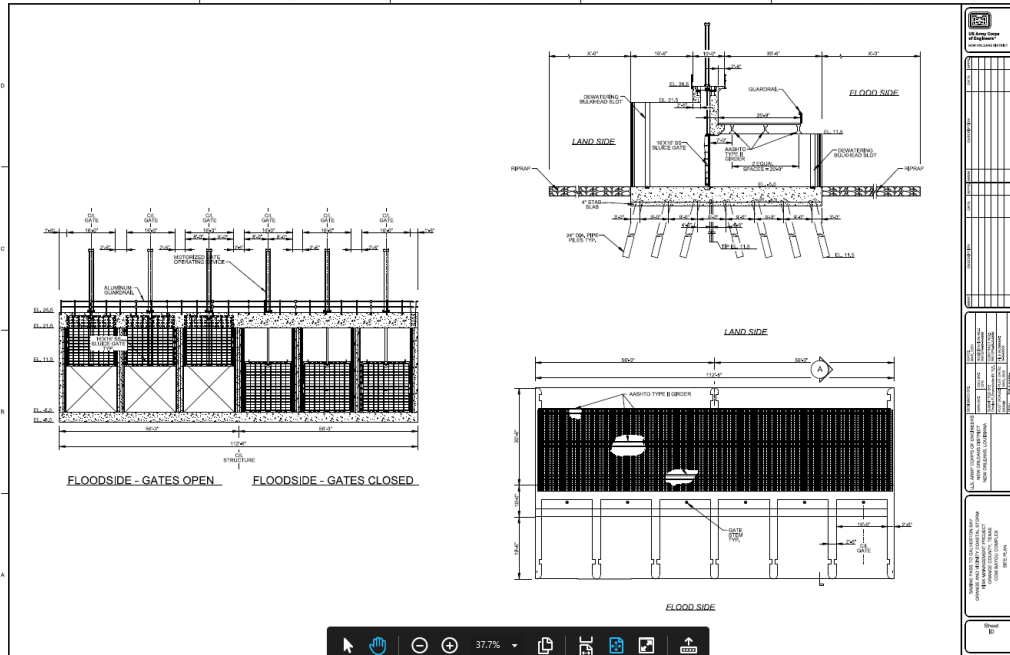

Figure 6-10: Shallow Water Environmental Gates (SWEG) (Technical Drawing)

The SWEGs are assumed to be constructed using conventional cast in place construction methods. A temporary retaining structure consisting of braced cofferdams that are dewatered to facilitate the construction of the structure. Because the SWEGs are located in the shallow portion of the Galveston Bay crossing, the dredging of floatation access will be required. It was assumed these structures will be constructed using equipment set on a floating plant. There are 16 SWEG's, however, it is assumed there will be two sets of dewatering bulkheads stored offsite that will be used to dewater these structures when maintenance is required.

It is understood that marine life at the bay bottom in the area of the SWEG's are sensitive to the surface texture of the bay. Due to the limited amount of modeling during the feasibility phase, this study has assumed a concrete foundation with riprap on both sides. During the planning, engineering and design phase (PED) different foundation's and scour protection measures will be investigated to make the bay bottom more similar to that of the existing bay bottom conditions. One of alternatives to a traditional foundation would be a three (3) sided culvert with narrow footings supporting the footings and the scour protection consisting of a something more consistent with the current bay bottom. This type of design will require significant modeling to understand the velocities in the vicinities of these gates. This modeling will be performed during the PED phase of the project.

6.3.6 Navigation Gates

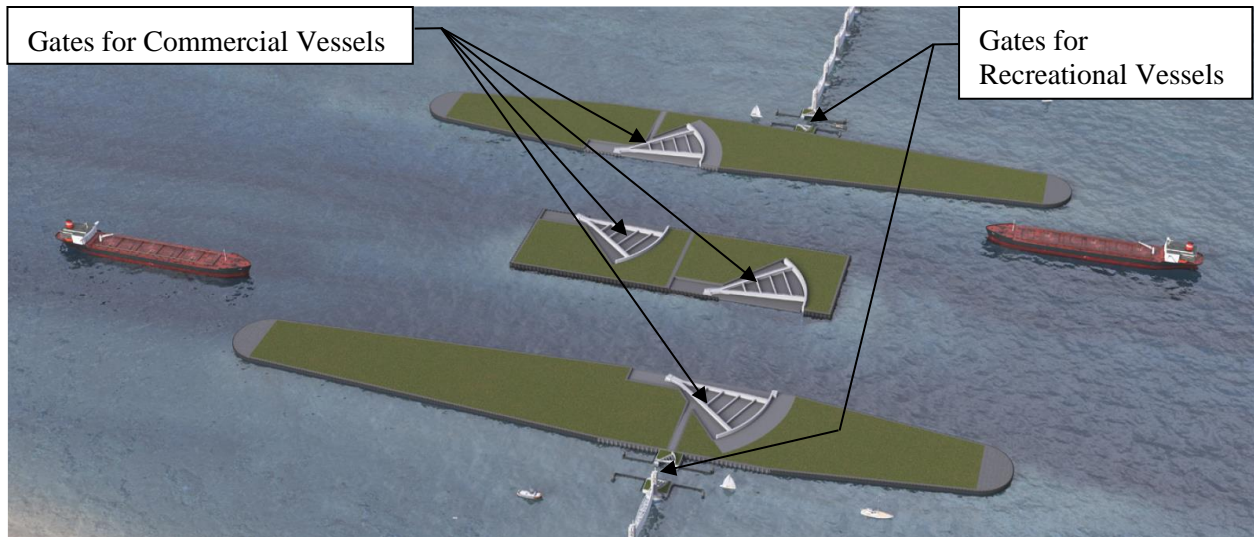

Figure 6-11: Houston Ship Channel Gate Complex (Conceptual Rendition)

The Houston Ship Channel (HSC) is the most active deep draft channel in the nation and is one of the hearts of the country's energy production. Galveston Bay sees both recreational and commercial vessels, for this reason, the Bolivar Road crossing must have navigation gates designed for both commercial and recreational vessels. Figure 6-11 shows a rendering of the system. Figure 6-12 shows the HSC navigation gate complex. The navigation gates are intended to remain open year-round to maintain continuous navigation and existing flow characteristics. The gates will be closed in the event of a tropical system threatening the coast. These sector gates are assumed to have a clear opening of 650' opening with sill elevation of El. -60.0'.

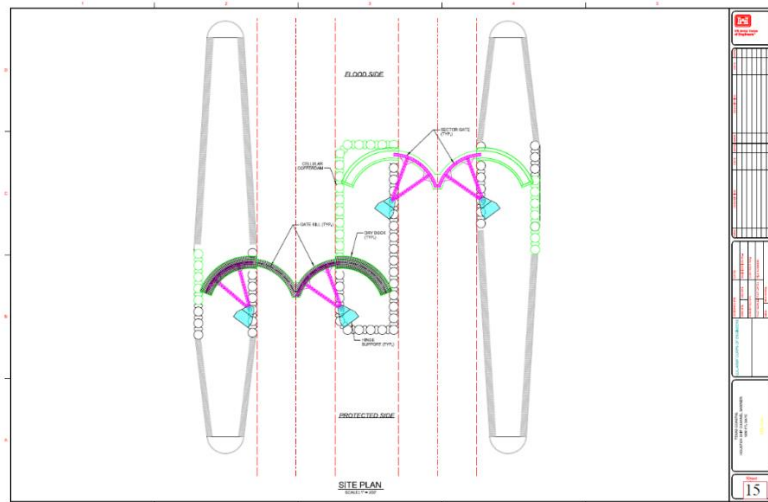

Figure 6-12: Houston Ship Channel Gate Complex (Annex 19)

6.3.7 **125' Recreational Vessel Sector Gate**

There is one 125' opening sector gate complexes on either side of the Houston Ship Gate Complex. This will prevent recreational vessels from having to cross the Houston Ship Channel to travel from the Galveston Bay side of the system to the Gulf of Mexico side. While the gates are open, the steel fabricated gates stored in the structure gate bays to protect them from vessel impact. Timber guide walls are also part of the complex. These sector gates are assumed to have a clear opening of 125' opening with sill elevation of El. -40.0. The feasibility level design assumed a large mat foundation supported on 24" Ø pipe piles. A blanket of scour will be placed on both the Flood and Land side of this structure to prevent erosion.

The sector gate is assumed to be constructed using conventional cast in place construction methods. A temporary retaining structure consisting of cellular cofferdams that are dewatered to facilitate the construction of the structure. This sector gate does not require the dredging of a floatation because the location of these structures already have adequate draft for the marine equipment required for construction.

The sector gate structures will have maintenance dewatering bulkheads that allow for the gate complex to be dewatered and the required maintenance can be done in the dry. Adjacent to the sector gate complexes. The gates will be designed to allow vehicles to use the gates as access from one side of the gate bay to the other side. The sector gate assumed for this study is modeled after the Harvey Canal Sector Gate constructed within in the New Orleans area. The Harvey Canal sector gate has been in service for over 10 years and have shown to be reliable. The New Orleans District and the rest of the Corps of Engineers have had great success with this type of floodgate, and these gates have proven to be reliable.

6.3.8 **650' Houston Ship Channel Gates**

A horizontally rotating floating sector gate was deemed most suitable for HSC. A complex of two (2) gates and associated artificial islands to store the gates is proposed for this crossing. The decision to use 2 smaller gates in lieu of one large gate was for redundancy in navigation and assist in the maintenance cycles. In the unlikely event, one of the gates will not open after a storm or there is maintenance that requires the gate to be closed, navigation can continue through the other gate. The gate openings are assumed to be 650 feet wide each with a sill elevation of El. -60.0. The gate opening was chosen in accordance with USACE document EM 1110-2-1100, Coastal Engineering Manual. Refer to Section 6.5.2 for details of how the gate width was determined. The gates are intended to remain open year-round to maintain continuous navigation and natural flow characteristics. The gates will be closed in the event of a tropical system threatening the coast. The feasibility level design assumed the gate will transfer all the lateral load to the hinge which is connected to a large mat foundation supported large

diameter steel pipe piles. A blanket of scour will be placed on both the Flood and Land side of this structure and around the islands to prevent erosion.

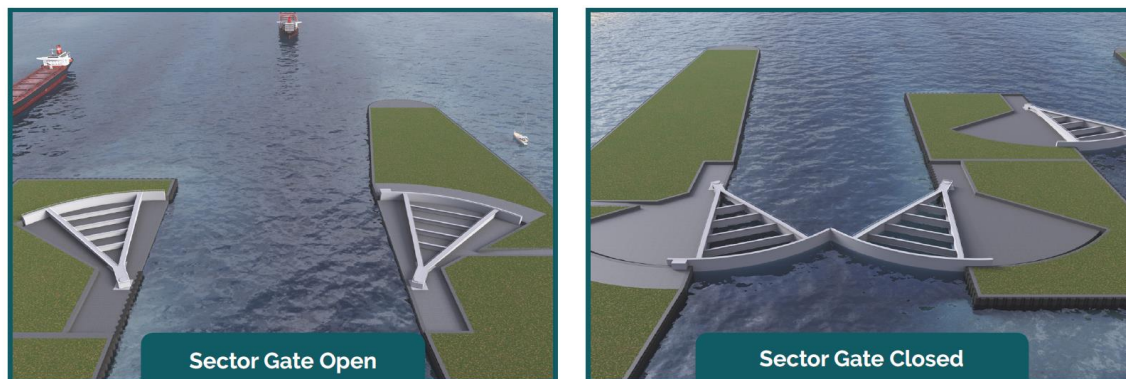

Figure 6-13: Shallow Water Environmental Gates (SWEG)

The gates will be stored in a dry dock within the manmade islands. The gates will be stored within the dry dock and only be deployed for a tropical event or for any required maintenance. With the floating sector gates in dry dock, this will help inhibiting corrosion and debris accumulation and facilitates routine maintenance. When it is time to employ the gate, the dry dock will be flooded allowing the gate to float into place and then water will be pumped in the sections of the gate allowing it to sink in place. Once the event has pasted, the gate sections will be pumped out and the gate will be floated back to the dry dock. With the gates stored within the dry dock area will help minimize the probability of vessel impacts while the gates are in the stored position.

The islands will be constructed with the perimeter of the island consisting of large cellular cofferdams backfilled with select fill material. The perimeter of the island will be constructed first followed by demucking the bay bottom and finally backfilled with dredged material to the final design grade. This sector gate does not require the dredging of a floatation because the location of these structures already have adequate draft for the marine equipment required for construction.

At no time will navigation be blocked during the construction of these gates. A temporary bypass channel will be dredged to allow for continued navigation. Prior to any island construction, navigation will be shifted to the bypass channel. Upon completion of one of the gate-and-island complexes, traffic will be diverted to the newly constructed channel and gate opening. At this point, the second gate and the other island will be constructed. The decision to construct two smaller gates in lieu of one large opening was, in part, to add some resiliency to the system. If after an event, if one of the gates has a problem opening, there will still be one lane open for navigation until the other gate is able to open. The selected gate was modeled after the gate constructed in St. Petersburg Russia and the Maeslant Barrier in the Netherlands. It was important to model these gates after similar existing gates to ensure the reliability of the gates when called on to open and close.

6.4 CSRM FEATURES IN GALVESTON ISLAND

The Galveston Ring Barrier System (GRBS) is a system of floodwalls, Navigation Sector gates, Shallow Water Environmental gates and roadway closure gates, and both roller and swing gates pump stations, and levee that provides flood risk management for approximately 15 square miles of the City of Galveston. The proposed GRBS incorporates the existing Seawall and proceeds counterclockwise from the west end of the Sewall north in the proximity of 103rd street to Offatts Bayou, crosses the Teichman Point area and ties into I-45, continues east along the Harborside area to the 47st street area, then continues north to the Galveston Ship Channel, then continues east through the Port of Galveston to UTMB, turns northward to the Ferry and then back south to the seawall. See Figure 6-14 below for a map of the GRBS. Details of plans and cross sections are available in Annex 19.

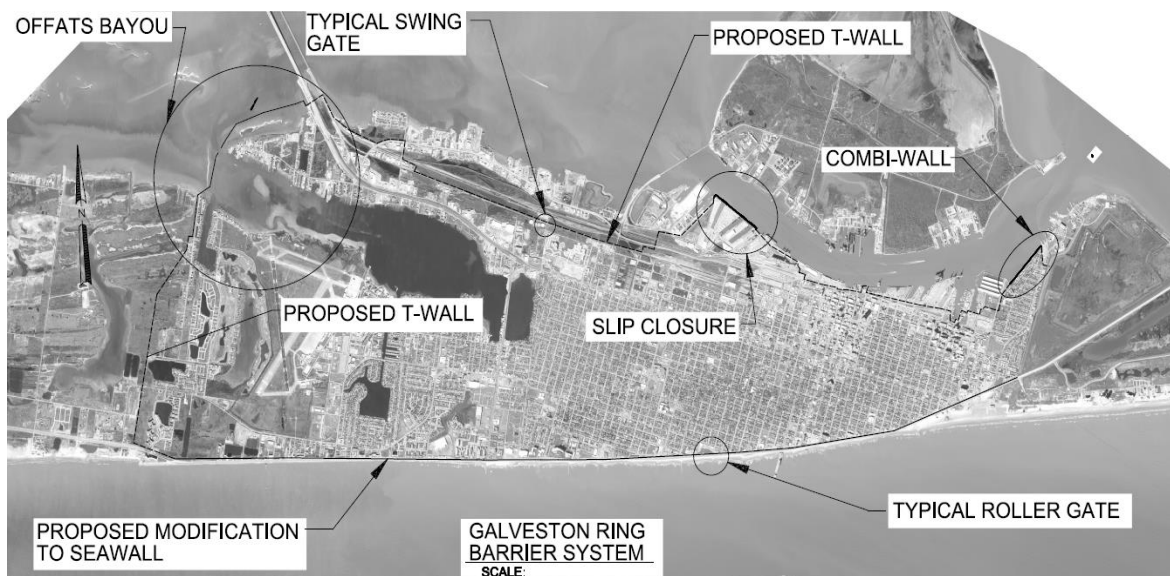

Figure 6-14: Galveston Ring Barrier System

The specifics of each reach along with rational of why the current alignment was chosen is discussed in detail in Section 4.4. The City of Galveston is a very developed area surrounded by environmentally critical habitat which made the establishment of the alignment of the GRBS very challenging. Numerous tradeoffs between project cost, project impacts and overall effectiveness of the GRBS were evaluated and made during the refinement of the alignment and additional evaluation should be made during the PED phase to optimize system performance by reducing impacts and project cost.

6.4.1 Flood Wall

Galveston Island has significant stretches that don't have the real estate to construct levees or are subject to barge or boat impacts. For those reasons, an inverted "T-wall" was deemed the most appropriate type of floodwall for the GRBS system. The assumption of a T-wall, allows flexibility in wall height, inverted "T-wall's do not have any height limitations.

Only one design section for Galveston Island was used to develop quantities and one load case (water to the top of the floodwall) was analyzed. A top of floodwall elevation of EL. 14.0 (NAVD 88) was assumed with an associated top of base slab elevation of EL. 0.0 (NAVD 88). The slab was assumed to be 3 foot thick.

The quantities assume a continuous line of steel sheet pile seepage cut-off wall driven under all of the T-walls. Pile capacity curves were provided by the geotechnical engineer based what is perceived to be the worst soil conditions. The wall is assumed to be founded on 18" Ø pipe piles.

The feasibility level design did not in a seismic analysis. This analysis will be done during the PED phase in accordance with ER 1110-2-1806 Earthquake Design and Evaluation for Civil Works Projects. Figure (6-15) shows a typical T-wall cross section rendering. Details of plans and cross sections are available in Annex 19.

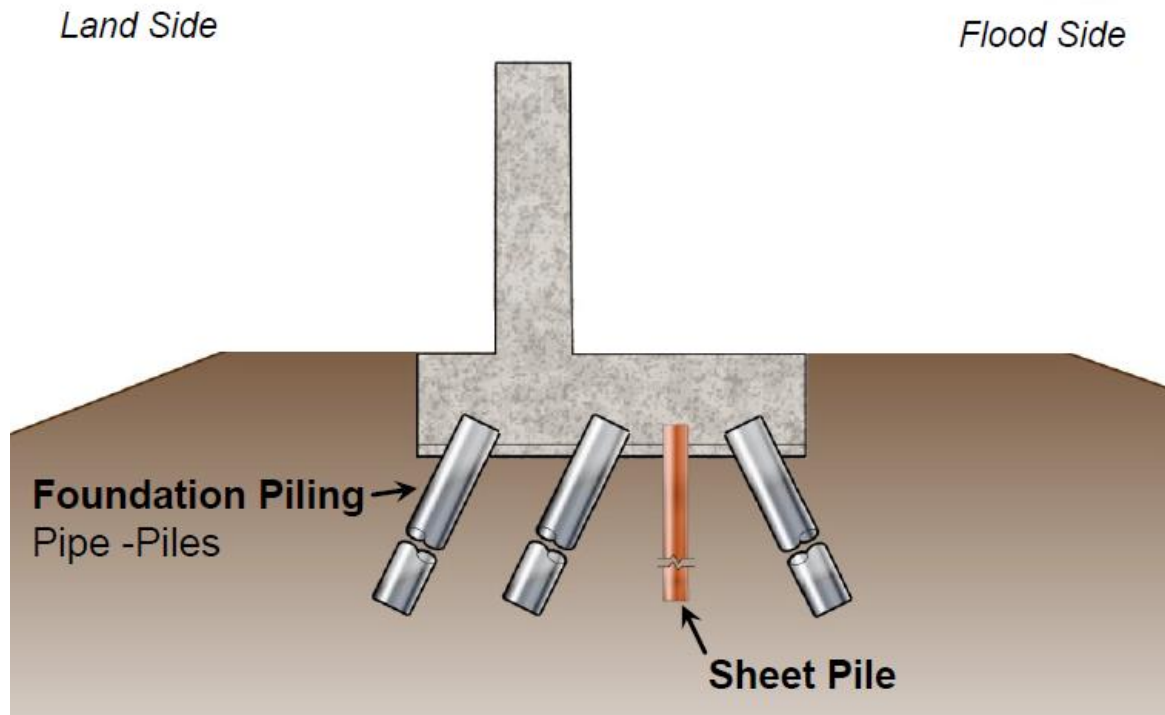

Figure 6-15: Typical Floodwall Section for the GRBS

6.5 OFFATTS BAYOU CROSSING

The closure of Offatts Bayou starts at the edge of the Galveston Bay Foundation (GBF) property continuing north then northeast offshore of the Teichman Point neighborhood then ending at the Offatts Bayou pump station adjacent to the Galveston Causeway. This project feature is a combination floodwall system (Combi-wall) that consists of vertical piling, batter piling and a concrete cap system.

This feature also includes a section of shallow water environmental gates/water circulation gates and two navigation sector gates. All of the Offatts Bayou structures will have a top of structure of +14.0. Please see Figure 6-16 below for a sketch of the Offatts Bayou Crossing. For further details, refer to Annex 17.

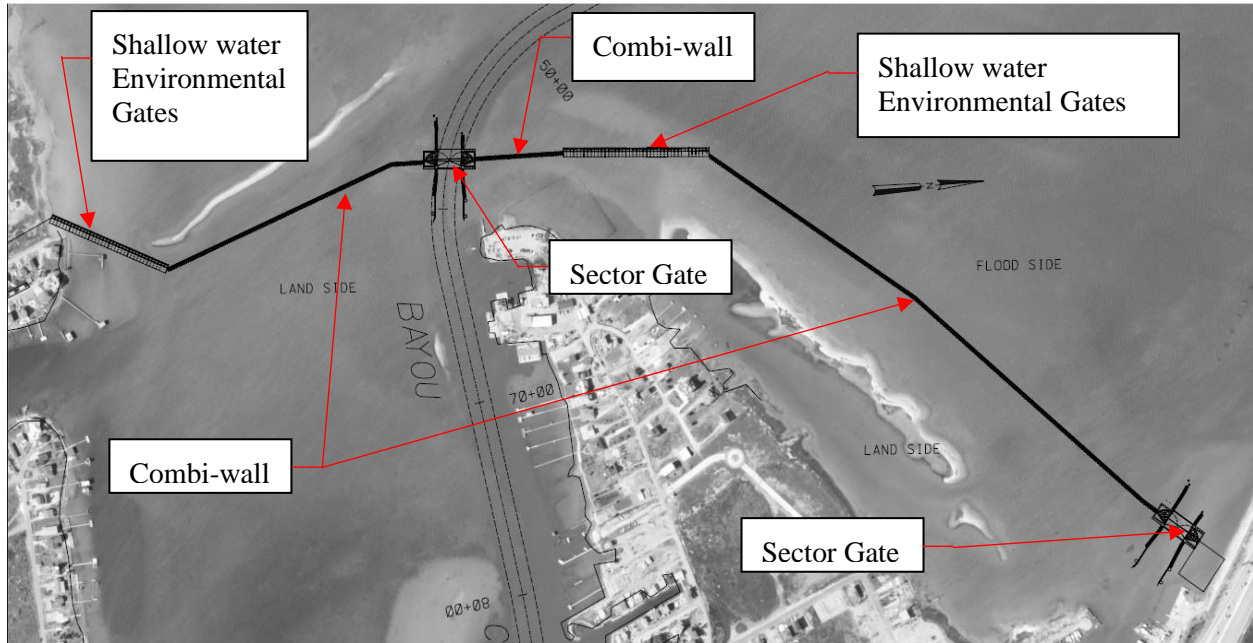

Figure 6-16: Offatts Bayou Crossing

6.6 ANALYSIS

The design process for all features was to assume water to the top of the protection and a low water on the landside.

For the natural ground elevation assumed for the GRBS was established from LiDAR survey data for the area.

6.6.1 Vessel Requirements:

EM 1110-2-1100 states the design vessel as “A hypothetical or real ship with dimensions of the largest vessels that a navigation project is designed to accommodate.” Prior to this study, there was a thorough review of the ship traffic seen by the Houston Ship Channel by both federal and non-federal entities. The Project Delivery Team (PDT) decided to use the design vessels used in “Houston Ship Channel Expansion Channel Improvement Project...” study, Table 3-1 and the design vessels used by the “Gulf Coast Community Protection and Recovery District (GCCPRD) Storm Surge Suppression Study, Phase 2 Report, March 23, 2016”. The Coastal Texas study has been able to leverage this existing data to develop a comprehensive list of design vessels. A list of the design vessels investigated are shown below in Table 6-5.

Table 6-5: List of Design Vessels Considered

Design Vessels per Table 3-1 of the Houston Ship Channel Expansion Study				
Type	Class	LOA	Beam	Draft
Containership	Gen II+	1100 ft	158 ft	49 ft
Containership	Gen II+	1200 ft	140 ft	49 ft
Tanker	Suezmax	935 ft	164 ft	54 ft
Design Vessel per GCCPRD Storm Surge Suppression Study, Phase 2 Report				
Type	Class	LOA	Beam	Draft
Containership	New Panamax	1200 ft	161 ft	50 ft
Design Vessel per Largest Commercial Vessel Class				
Type	Type	Type	Type	Type
Containership	ULCV	1312 ft	193.5 ft	52.5 ft

6.6.2 **Determination of Gate Width**

Chapter V-5-6 of EM 1110-2-1100, “Channel Alignment and Width” discussed the width requirements for both Inner Channels (protected waters) and Entrance channels (areas with intensive waves and currents). The EM recommends the channel width be based on the factors listed in Table V-5-9 for both interior and entrance channels. This table was used to estimate the feasibility level specified design gate opening for this study. The table shown below is an excerpt from Table V-5-9 showing the factors to be used to determine the necessary channel width.

Table 6-6: Design Factors

Per Table V-5-9 from EM 1110-2-1100					
Location		Vessel Controllability			Channels with Yawing Forces
		Very Good	Good	Poor	
B	Maneuvering lane, Straight channel	1.6	1.8	2	Judgment
A	Bank Clearance	0.6	0.6+	0.6+	1.5

$$\begin{aligned}
 \text{Channel Width} &= (\text{Bank Clearance} * \text{Ship Beam Width}) \\
 &+ (\text{Maneuvering Lance factor from table} * \text{Ship Beam Width}) \\
 &+ (\text{Bank Clearance} * \text{Ship Beam Width})
 \end{aligned}$$

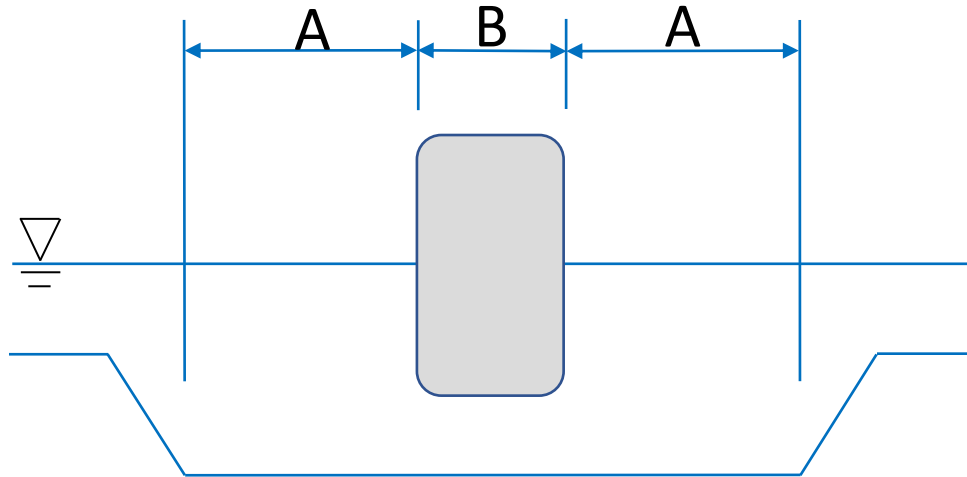

Figure 6-17: Table V-5-9 Clearance Factors

Table 6-7: Channel Widths based on Table V-5-9 from EM 1110-2-1100

Type	Beam	Bank Clearance Factor, A	Maneuvering lane, Straight Channel Factor, B	Required Channel Width
Containership, Gen II +	158 ft	1.00	2.00	632 ft.
Containership, Gen II +	140 ft	1.00	2.00	560 ft.
Tanker, Suezmax	164 ft	1.00	2.00	656 ft.
Containership, New Panamax	161 ft	1.00	2.00	644 ft.
FPMC C Melody *	220 ft	1.00	2.00	880 ft.

* The FPMC C Melody vessel passing through the gate would be an extreme situation

Based on the above calculations, a gate width of 656 ft is required for HSC. This width is based on conservative assumptions for both maneuvering lane and bank clearance factors. The vessel FPMC C Melody is an extreme case ship and should be able to navigate the opening with the assistance of tugs ensuring a safe passage through the gates.

Table V-5-10 of EM 1110-2-1100 provides an alternative method to calculate the required gate opening. The factors shown in this table are based on USACE studies and experience with ship simulators from past navigation projects. These simulation studies have indicated the traditional channel width design criteria is overly conservative. Table V-5-10 of EM 1110-2-1100 offers interim guidelines for channel width requirements based on the previously mentioned simulation studies. An excerpt Table V-5-10 is shown in the table below:

Table 6-8: Design Factors

Table V-5-10 from EM 1110-2-1100 One-Way Ship Traffic Channel Width Design Criteria			
Channel Cross Section	Design Ship Beam Multipliers for Maximum Current, Knots		
	0.0 to 0.5 (kts)	0.5 to 1.5 (kts)	1.5 to 3.0 (kts)
Constant Cross Section, Best Aids to Navigation			
Shallow	3.00	4.00	5.00
Canal	2.50	3.00	3.50
Trench	2.75	3.25	4.00
Variable Cross Section, Average Aids to Navigation			
Shallow	3.50	4.50	5.50
Canal	3.00	3.50	4.00
Trench	3.50	4.00	5.00

Table 6-9: Channel Widths based on Table V-5-10 from EM 1110-2-1100

Channel Width based on Vessel Selection			
Type	Beam	Factor from Table 6-7	Required Channel Width
Containership, Gen II +	158 ft	3.50	553 ft.
Containership, Gen II +	140 ft	3.50	490 ft.
Tanker, Suezmax	164 ft	3.50	574 ft.
Containership, New Panamax	161 ft	3.50	564 ft.
FPMC C Melody *	220 ft	3.50	770 ft.

Channel Width = (Table V-5-10 factor) * (Ship Beam Width)

The FPMC C Melody is an extreme case ship and will be able to navigate the opening with the assistance of tugs ensuring a safe passage through the gates

A factor of 3.5 was chosen from Table V-5-10 based on the assumption of a constant “canal” cross section.

This EM defines a canal cross section as a narrow, fully restricted channels with clear and visible banks. It has been assumed that there will be negligible yawing forces occurring because the currents are aligned with the channel and the gate complex consists of large islands that extend from either side of the gates. These islands will help reduce yawing forces acting on the vessels passing through the complex. The assumed channel current ranging from 1.7 to 2.3 knots are based on the U.S. Coast Pilot

5, Chapter 10, 22 Mar 2020, chart 11326, Paragraph (210). The existing average current velocity in the project location between the jetties at strength is 1.7 knots on the flood and 2.3 knots on the ebb. However, upon completion of the complex, the velocities will likely increase above 3 knots, therefore a detail study will be conducted during PED to determine the final required gate opening.

The above paragraphs indicate a required gate width to be 574 feet or 656 feet. A preliminary gate width of 650 feet at HSC was chosen for this study.

6.6.3 **Structural Analysis, Load Cases and Factors & Future Investigations**

The analysis performed during this feasibility study assumed a conservative load case (as discussed above) to determine the main member sizes, pile layout and quantities. During PED, a detailed program will be developed using the current engineering manuals to determine all of the required load case, load factors and any other pertinent design data. Typical design parameters to be used during the PED phase are listed below:

- Ko: 0.8 (at-rest earth pressure coefficient)
- Unit weight (soil), $\gamma = 110$ pcf
- Unit weight (concrete), $\gamma = 150$ pcf
- Unit weight (water), $\gamma = 64.0$ pcf
- Concrete: normal weight, $f_c = 5$ ksi (w/c = 0.4)
- Reinforcing steel: ASTM A615, $f_y = 60$ ksi

The load cases for the design during PED, as shown in Table 6-10, are based on Multiple EM's and the HSDRRDG. This table is a basic table, the magnitude and complexity of the barrier system will require more structure-specific load cases that will be determined during PED.

Table 6-10: Design Load Cases

LC #	Load Case	Load Category	Open / Closed?
1	Construction D + EH + EV + ES _N	Unusual	
2A	Normal Operating - Gates Loaded D + EH + EV + HS _U + U	Usual	Closed
2B	Normal Operating - Gates Unloaded D + EH + EV + HS _U + Q _U + U	Usual	Closed
2C	Normal Operating - Gates Operating D + EH + EV + HS _U + Q _U + U	Usual	Operating
2	Normal Operating D + EH + EV	Usual	Open
3	Surge Stillwater D + EH + EV + HS _N + U	Usual	Closed
4	Infrequent Surge Stillwater + Coincident Wave D + EH + EV + HS _N + HW _N + W + U	Unusual	Closed
5	Infrequent Surge Stillwater + Impact D + EH + EV + HS _N + I + U + W	Unusual	Closed
6	Maximum Surge Still Water + Coincident Wave D + EH + EV + HS _X + HW _N + U + W	Extreme	Closed
7	Maximum Surge Still Water + Impact D + EH + EV + HS _X + I + U + W	Extreme	Closed
8	Maximum differential head + Wave D + EH + EV + HS _X + U + HW _X + W	Extreme	Closed
9	Maximum differential head + impact D + EH + EV + HS _X + U + I	Extreme	Closed
10	Reverse head condition D + EH + EV + HS _N + U	Usual	Closed
11	Coincident Pool + OBE D + EH + EV + HS + ODE + U	Unusual	Open
12	Coincident Pool + MDE D + EH + EV + HS + MDE + U	Extreme	Open
13	Maintance/ Dewatered Condition D + EH + EV + HS + U	Unusual	Open

- D Dead Load
- EH Lateral Earth
- EV Vertical Earth
- ES_N Soil Surcharge
- HS_U Water at highest head differential level with < a 10-year return period.
- Q_U Reaction from Operating Equipment
- HS_N Design surge still water condition on unprotected side
- HS_X Maximum surge still water condition on unprotected side
- HS_N Reverse head condition
- HW_N Governing wave conditions coincident with design surge still water
- HW_X Governing Wave conditions during an extreme event
- W Wind Loading
- I Barge Impact
- HS Water at level representing mean annual tide pool conditions.
- MDE Earthquake (Maximum Design Earthquake (MDE))
- OBE Earthquake (Operating Basis Earthquake (OBE))
- U Uplift

6.7 SCOUR PROTECTION

This design focused on a scour protection that could fully withstand extreme surge conditions without significant damage. The scour protection is based on hydraulic loads caused by a hurricane as well as hydraulic loads caused by regular tidal flow. The extent of scour protection is based on jet dissipation of energy to avoid further erosion where the scour protection terminates. The scour protection would have to be able to handle large flow velocities to prevent undermining and failure of the entire structure. A blanket of scour has been placed on both the Flood and Land side of this structure to prevent erosion. It is understood that marine life at the bay bottom in the area of the SWEG's are sensitive the surface

texture of the bay. Due to the limited amount of modeling during the feasibility phase, this study has assumed a concrete foundation with riprap on both sides. Experts from the I-Storm group were contacted for the scour pad design. Based on their recommendation, roughly 500 ft scour pad along the flood and protected side with a thickness of 5 ft has been proposed (Figure 6-18). This is similar to the scour pad used for the Wester closure complex in New Orleans. During the planning, engineering and design phase (PED) different foundation's and scour protection measures will be investigated to make the bay bottom more similar to that of the existing bay bottom conditions. One of alternatives to a traditional foundation would be a three (3) sided culvert with narrow footings supporting the footings and the scour protection consisting of a something more consistent with the current bay bottom. This type of design will require significant modeling to understand the velocities in the vicinities of these gates.

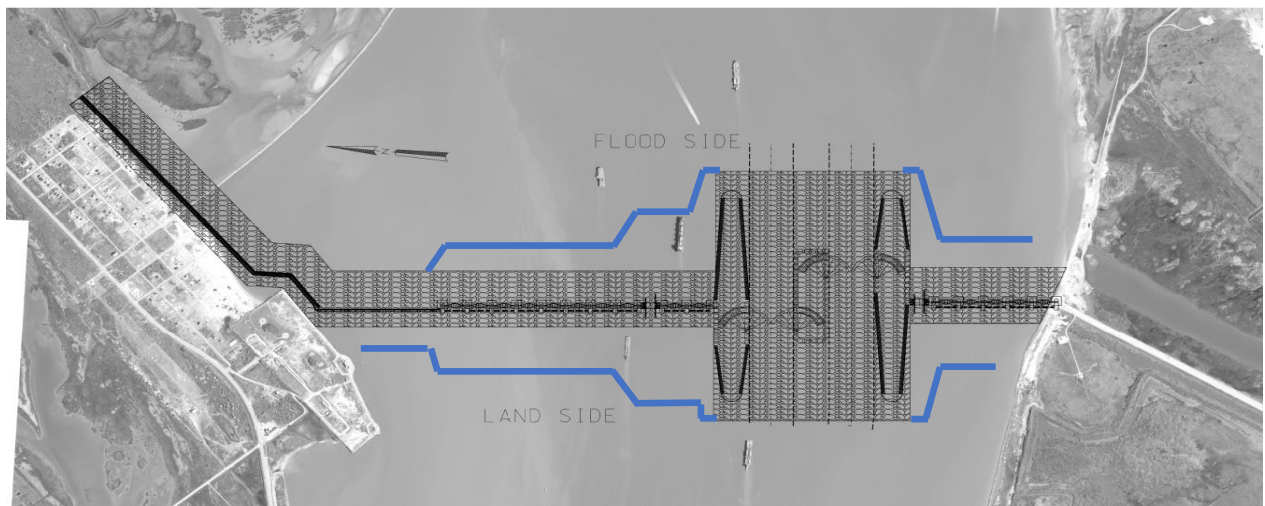

Figure 6-18: Scout Pad along Bolivar Road Gate Complex

6.8 SEAWALL IMPROVEMENT

As discussed before, the Galveston seawall improvement feature is a future adaptation to provide additional storm surge and wave overtopping reduction along Galveston Island, which will connect to the storm surge gate at Bolivar Roads and the beach dune system. The recommendation is to increase the height of 10 miles of the existing seawall to reach a uniform level of protection of 21.0 ft (NAVD88). The extension would go from the San Jacinto levee seawall tie-in to the west end tie in of the GRBS. Figure 6-19 shows a typical section of the proposed improvements to the Galveston seawall.

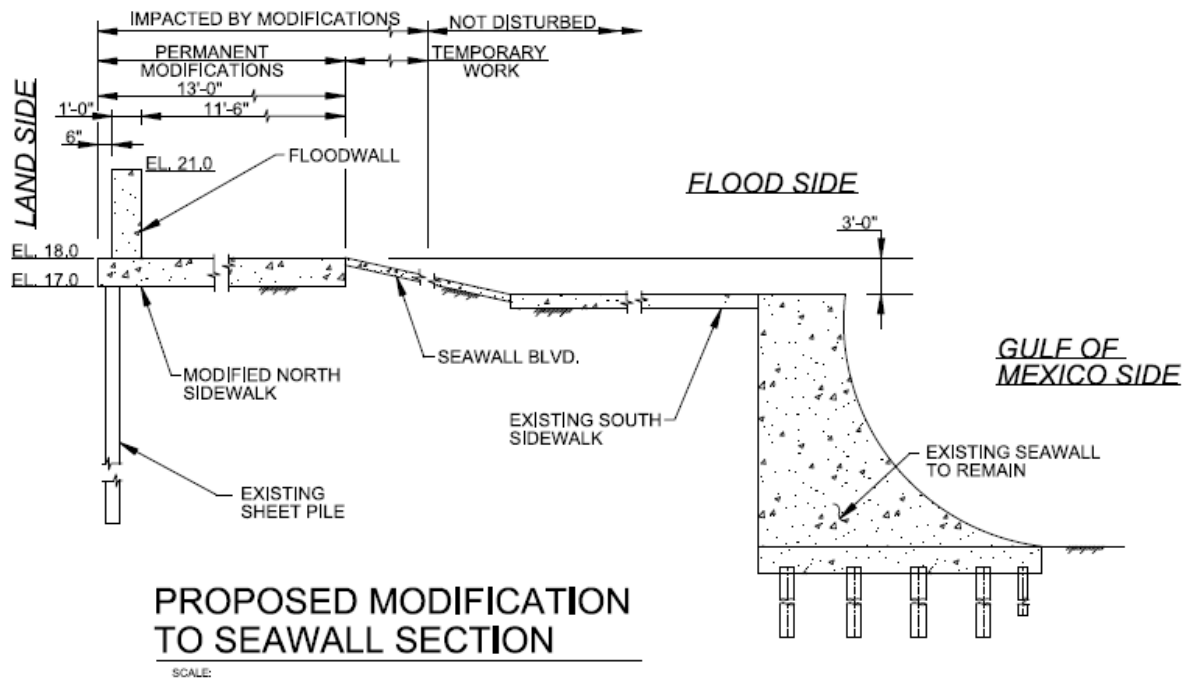

Figure 6-19: Typical Seal Wall Improvement Section (Annex 19)

This section describes the ecosystem restoration (ER) measures included in the Recommended Plan. These measures are described below, and include the description, project need, FWOP, and similarity to the GLO's Texas Coastal Resiliency Master Plan. To provide a brief FWOP description for all the Ecosystem Restoration measures, the NOAA (2017) 3-foot RSLC for the upper coast, 2.5 feet for the central coast, and 2 feet for the lower coast was used to provide a general acreage of habitat that would be impacted for that Ecosystem Restoration measure. The NOAA (2017) data does not consider natural processes such as erosion or marsh migration that would be affected by future RSLC.

Engineering assumptions for the ER measures were presented in Section 4, the Geotechnical section of this Appendix. Complete ER design drawings are included in Annex 20.

7.1 CHANGES TO ER MEASURES FOLLOWING THE AGENCY DECISION MILESTONE

Several changes were made to the ER measures in the recommended plan following the ADM, as follows:

Out-year marsh nourishment and future construction activities were removed. Measures G-28, B-12, M-8, and CA-5 included nourishment in areas that will become progressively more susceptible to marsh loss and conversion to open water given RSLC projections. Additionally, measure W-3 included maintenance dredging of the Mansfield channel to preserve hydrologic connectivity. These future activities were excluded based on USACE policy.

Measure G-5 was removed from the overall recommended ER plan. While there is still ER benefit to the beach and dune nourishment, this feature is now part of the region 1 CSRSM recommendation.

7.2 G-28 – BOLIVAR PENINSULA AND WEST BAY GIWW SHORELINE AND ISLAND PROTECTION

This measure consists of shoreline protection and restoration utilizing 36 miles of rock breakwater at a crest height of 7 feet with 2H:1V side slopes and a base width of 46 feet, 18 acres of oyster cultch creation, 664 acres of marsh restoration, and 5 miles of island restoration. The island restoration feature will be protected by an additional 5.1 miles of breakwaters.

The construction of the rock breakwaters will reduce erosion, and preserve marsh habitat, along unprotected segments of shoreline including approximately 27 miles of the GIWW along Bolivar Peninsula and 9 miles along north shore of West Bay. Absent shoreline protection the average erosion along the GIWW is approximately 4 feet per year primarily associated with ship wake from barge traffic. Similar breakwaters have been successful in reducing erosion, and in some circumstances

promoting accretion, elsewhere along the Texas coast (e.g., through McFaddin National Wildlife Refuge). The crest elevation was identified based on the intent to provide erosion protection over the 50-year period assuming intermediate RSLC. No breakwaters would be constructed where the GIWW shoreline is a dredged material placement area.

A degraded island extending approximately 5 miles and covering 251 acres will be restored in West Bay using sediment dredged in association with construction of the CSRMs gate features at Bolivar Roads. The island will be protected on the GIWW side using rock breakwaters similar to those on the opposite side of the GIWW. On the bay side of the restored island, 18 acres of oyster cultch will provide natural protection. In addition to the habitat benefit associated with this feature, the island will enhance navigation and vessel safety in the GIWW by reducing the existing uninterrupted fetch in West Bay.

Sediment sources for G-28 East are shown on Figure 7-1 and for G-28 West are shown on Figure 7-2. Sediment volumes for G-28 is summarized in Table 7-1.

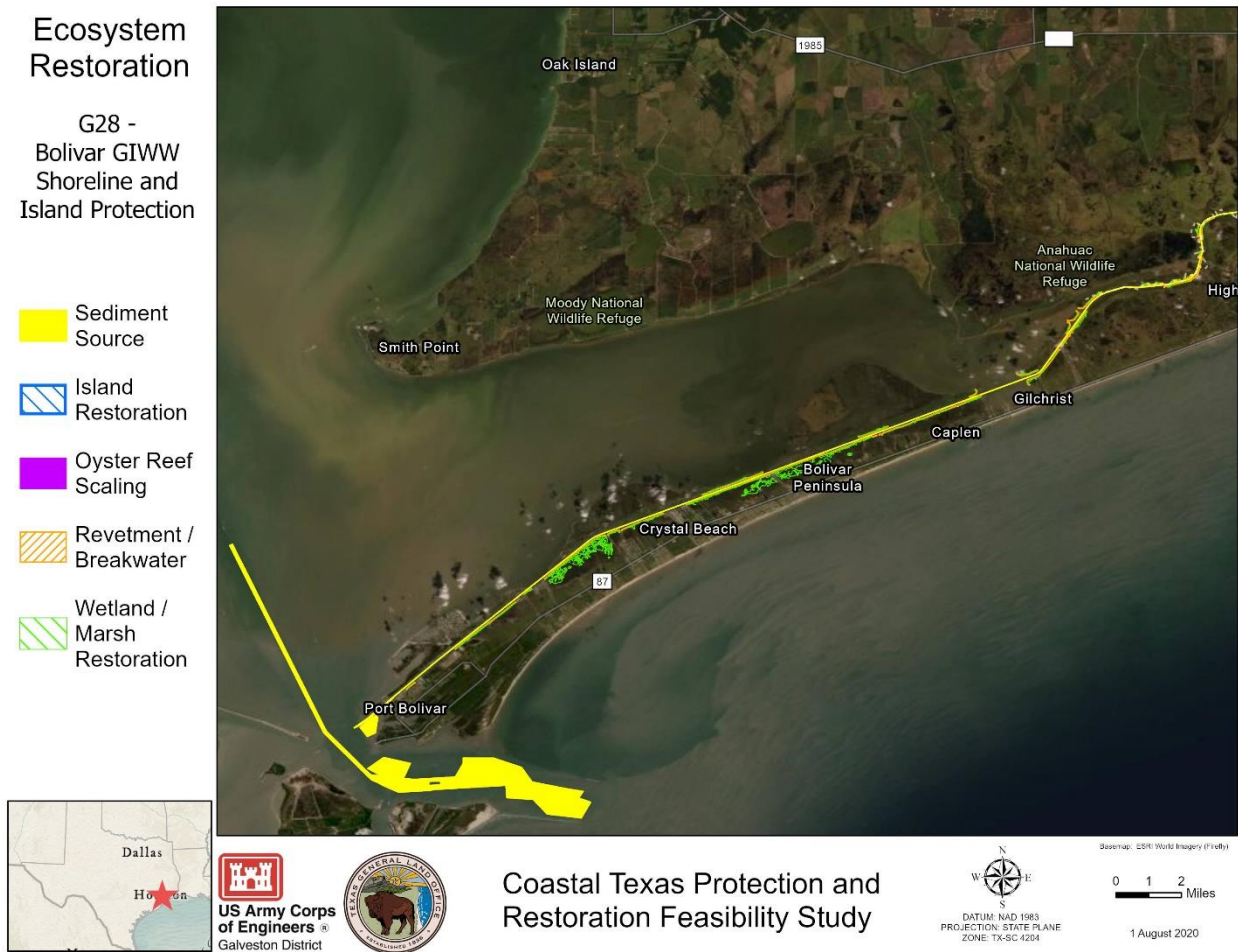

Figure 7-1: G-28 – Bolivar and West Bay GIWW Shoreline and Island Protection East

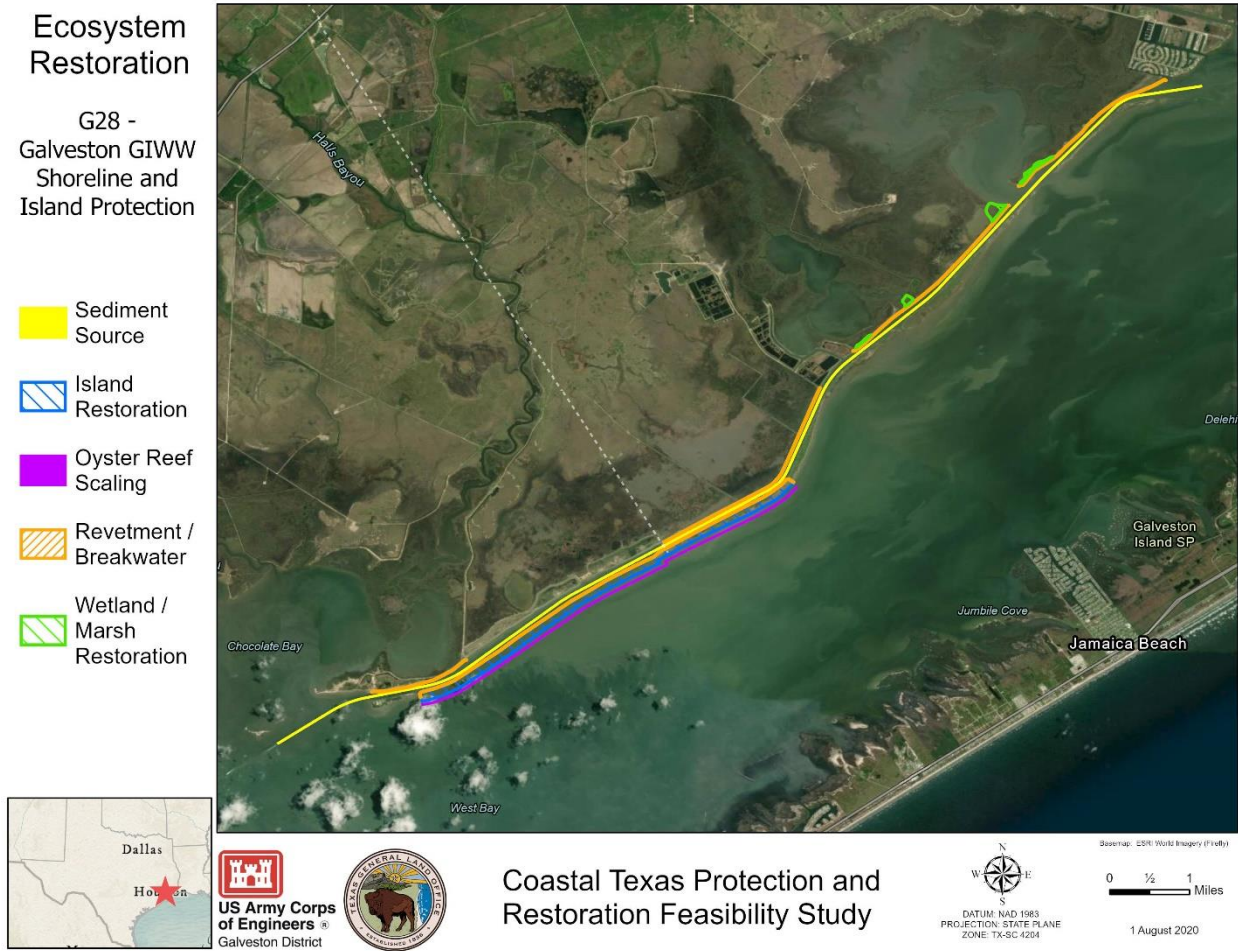

Figure 7-2: G-28 – Bolivar and West Bay GIWW Shoreline and Island Protection West

Table 7-1: G-28 Sediment Volumes

Measure	Sediment Volume Required (cy)	
	Marsh Creation and Restoration	Island Creation and Restoration
G-28	715,047	5,822,917

7.3 B-2 – FOLLETS ISLAND GULF BEACH AND DUNE RESTORATION

This beach nourishment and dune restoration measure includes 1,113.8 acres/10.1 miles of dune/beach restoration along the Gulf shoreline on Follets Island in Brazoria County, Texas. The dune would have a crest elevation of 9 feet, width of 10 feet with 5H:1V slopes, and 200 feet of additional subaerial equilibrated beach.

It would create habitat, protect beaches and dunes from breaches and erosion caused by storm surge and RSLC, and would protect inland wetlands, seagrass meadows, and habitat along with back-bay marshes which would be harmed if the Gulf shoreline and dune system were breached. The placement of additional sediment will have the benefit of replacing sediment deficits on the upper coast.



This measure would protect State Highway 257 which is the only road accessing and providing evacuation capability to the east towards Galveston Island and to the west towards Freeport. Follets Island protects Bastrop, Christmas, and Drum bays, and the Brazoria National Wildlife Refuge (NWR) on the mainland behind this bay system. This measure would also protect seagrasses in Christmas Bay, extensive marshes throughout the bay complex, and scattered residential developments. Christmas Bay is a designated Gulf Ecological Management Site because of its relatively undeveloped shorelines, high water quality, and unique mix of seagrass meadows, oyster reefs, and smooth cordgrass marsh; it is also a TPWD Coastal Preserve.

While future renourishment of this feature is not included, this feature is downdrift of the beach and dune nourishment for CSRSM purposes along Bolivar and Galveston. Follets Island is likely to benefit throughout the period of analysis from the regional of beach nourishment.

The beach and dune restoration requires 802,000 CY of beach quality sand that will be dredged from the Sabine and Heald Banks (fig. 7-3). Other potential nearshore sediment sources, e.g., nearshore sediment waves, will be evaluated during PED for potential reduction in cost.

Ecosystem Restoration

B2 - Follets Island Gulf Beach and Dune Restoration

-  Dune and Beach Restoration
-  Sediment Source



Coastal Texas Protection and Restoration Feasibility Study

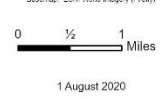

Figure 7-3: B-2 – Follets Island Gulf Beach and Dune Restoration

7.4 B-12 – WEST BAY AND BRAZORIA GIWW SHORELINE PROTECTION

This measure consists of shoreline protection and restoration utilizing 43 miles of rock breakwater at a crest height of 7 feet with 2H:1V side slopes and a base width of 46 feet, 0.17 acre of oyster cultch creation, 551 acres of marsh nourishment.

The construction of the rock breakwaters will reduce erosion of critical reaches of shorelines on the western side of West Bay and Cowtrap Lakes, and about 40 miles along selected segments of the GIWW in Brazoria County. The measure will protect critical reaches in Oyster Lake from breaching into West Bay by adding about 0.7 mile of oyster cultch to encourage the creation of oyster reef.

The measure would restore habitat and protect critical reaches of shoreline in this bay complex from breaching and impacting marsh, oysters, colonial waterbird rookeries and other habitats in the complex through erosion and changes in circulation. It would also reduce shoreline breaches and marsh erosion during storm events and erosive effects of vessel wakes, creating a more sustainable marsh with future

RSLC. The crest elevation was identified based on the intent to provide erosion protection over the 50-year period assuming intermediate RSLC. Sediment from GIWW BUDM (one O&M cycle) will be used for the marsh restoration and nourishment (Figure 7-4). The sediment borrow volume for the marsh effort is 639,105 cy.

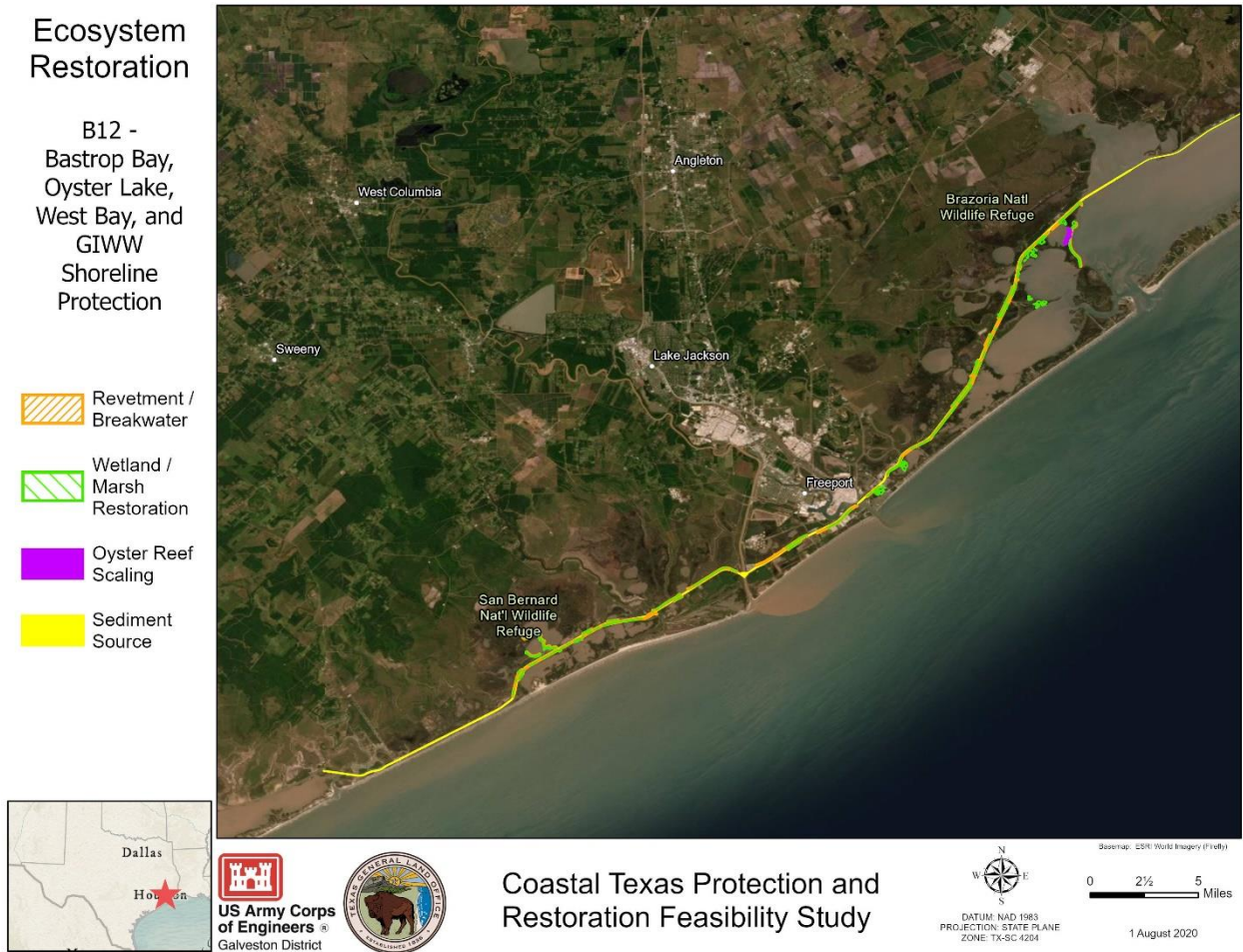

Figure 7-4: B-12 – West Bay and Brazoria GIWW Shoreline Protection

7.5 CA-5 – KELLER BAY RESTORATION

This measure consists of shoreline protection and restoration utilizing 3.8 miles of rock breakwater at a crest height of 7 feet with 2H:1V side slopes and a base width of 46 feet, and 2.3 miles of oyster reef creation by the use of reef balls along Sand Point in Lavaca Bay nearshore waters.

The construction of the rock breakwaters would reduce erosion of about 5 miles of Matagorda Bay shoreline adjacent to Keller Bay and would aid in the protection of 295.8 acres of SAV that occurs along the shoreline of Keller Bay.

The measure would prevent the southern Keller Bay shoreline from breaching into Keller Bay with subsequent loss of intertidal marsh, SAV beds and oyster reef in Keller Bay and provides for the protection of area north of Sand Point.



Figure 7-5: CA-5 – Keller Bay Restoration

7.6 CA-6 – POWDERHORN SHORELINE PROTECTION AND WETLAND RESTORATION

This measure consists of shoreline protection and restoration utilizing 5.0 miles of rock breakwater at a crest height of 7 feet with 2H:1V side slopes and a base width of 46 feet, and 529 acres of wetland and marsh restoration.

The measure would restore and reduce erosion of about 6.7 miles of Matagorda Bay shoreline fronting portions of the community of Indianola, Powderhorn Lake estuary, and TPWD’s Powderhorn Ranch by restoring marsh at three areas protecting estuarine bays and bayous between Powderhorn Lake and Port O’Connor. The shoreline in the northern part of this area is mainly crushed shell with a little sand,

becoming more of a sandy shoreline moving south to Port O'Connor. The shoreline is heavily used for recreation. Shoreline stabilization to include breakwaters will maintain circulation.

The measure provided for the protection of intertidal marsh and ecological integrity of Powderhorn Lake estuary and several minor estuaries occurring along the Powderhorn Ranch shoreline. At present, the shoreline and various inlet have been eroding relatively rapidly. BUDM associated with O&M dredging of the MSC is the borrow source for the marsh restoration (Fig. 8-6) with a volume of 432,288 cy.

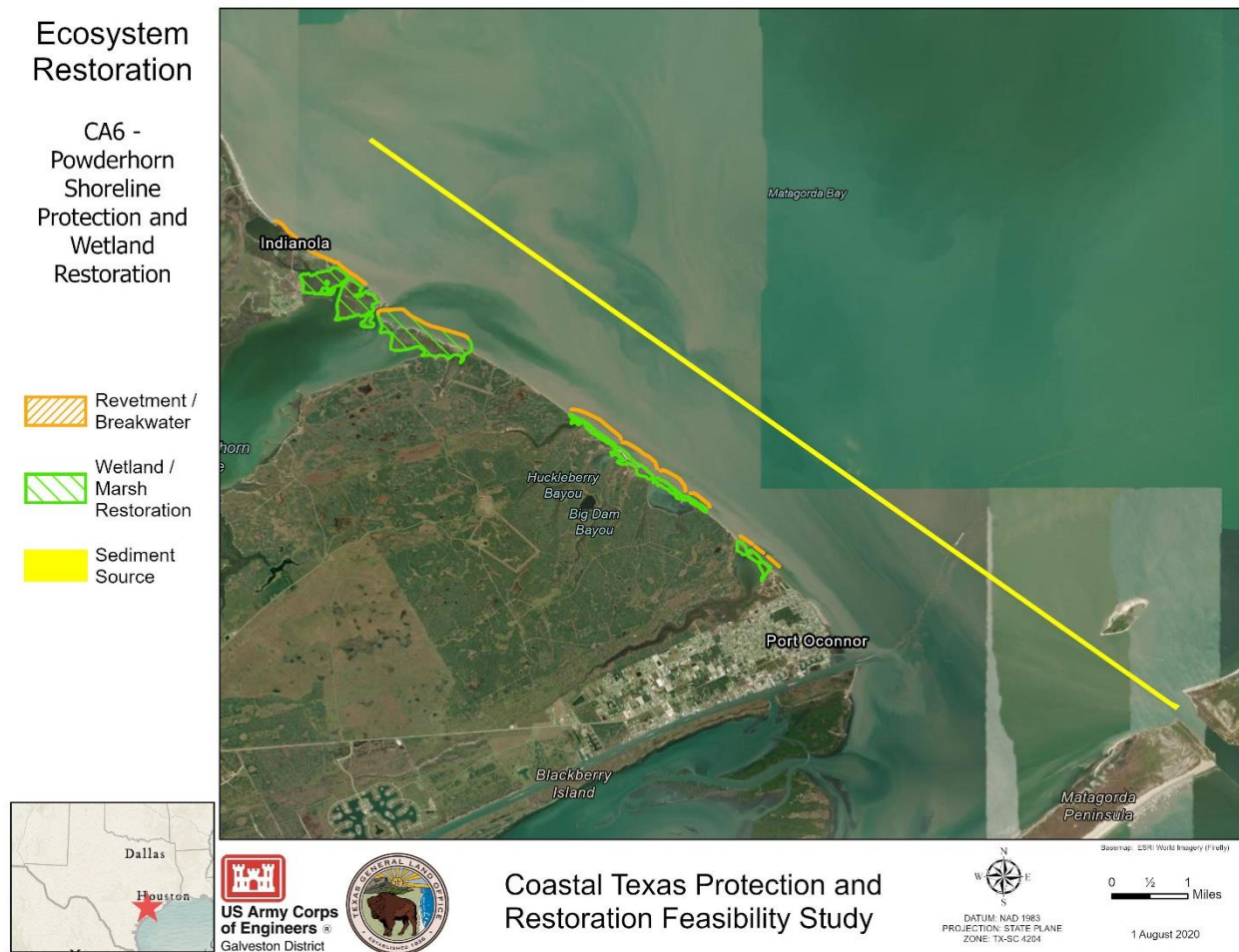

Figure 7-6: CA-6 – Powderhorn Shoreline Protection and Wetland Restoration

7.7 M-8 – EAST MATAGORDA BAY SHORELINE PROTECTION

This measure consists of shoreline protection and restoration utilizing 12.4 miles of rock breakwater at a crest height of 7 feet with 2H:1V side slopes and a base width of 46 feet. The measure provides for 96 acres of island restoration, 236 acres of wetland and marsh restoration, and 14.6 acres of oyster reef creation.

The construction of the rock breakwater will reduce erosion of 12 miles of unprotected segments of the GIWW shoreline and associated marsh along the Big Boggy National Wildlife Refuge shoreline and eastward to the end of East Matagorda Bay. No breakwaters would be constructed where portions of the GIWW shoreline are stabilized by adjacent dredged material placement areas. Absent shoreline protection the average erosion along the GIWW is approximately 4 feet per year primarily associated with ship wake from barge traffic. Similar breakwaters have been successful in reducing erosion, and in some circumstances promoting accretion, elsewhere along the Texas coast (e.g., through McFaddin National Wildlife Refuge). The crest elevation was identified based on the intent to provide erosion protection over the 50-year period assuming intermediate RSLC.

GIWW BUDM will be used for the marsh nourishment features; mining of the upland confined placement area will provide sediment for the island restoration. Breakwaters will also be constructed as the erosion protection for the island feature on the GIWW side, an additional 3.5 miles. Oyster cultch will be placed on the bayside of the island. Sediment volumes for the features in M-8 are summarized in Table 7-2.

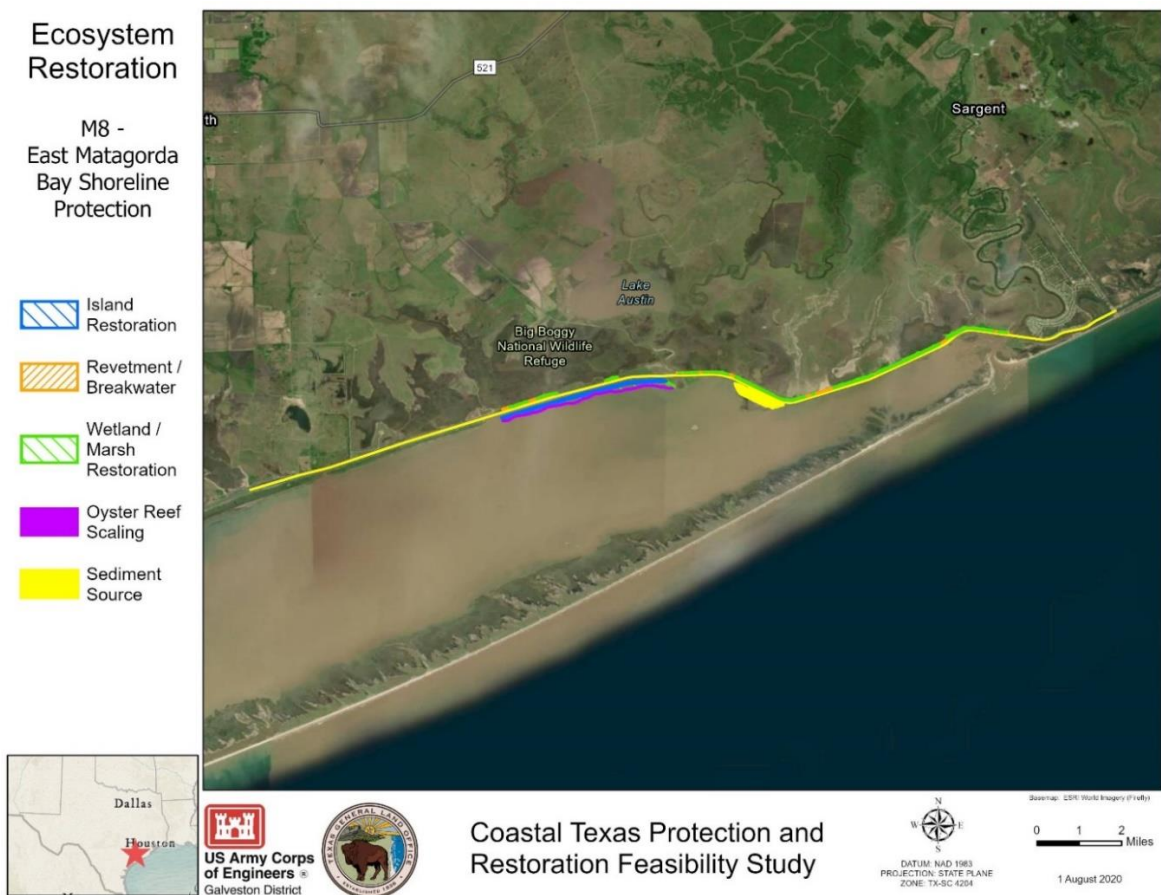

Figure 7-7: M-8 – East Matagorda Bay Shoreline Protection

Table 7-2: M-8 Sediment Volumes

Measure	Sediment Volume Required (cy)	
	Marsh Creation and Restoration (Initial)	Island Creation and Restoration
M-8	247,778	1,195,299

7.8 SP-1 – REDFISH BAY PROTECTION AND ENHANCEMENT

This measure consists of shoreline protection and restoration utilizing 7.4 miles of rock breakwaters at a crest height of 7 feet with 2H:1V side slopes and a base width of 46 feet.

The measure provides for the restoration of the Dagger, Ransom, and Stedman island complex in Redfish Bay by the construction of 4.75 miles of breakwater along the unprotected GIWW shoreline along the backside of Redfish Bay and 2.75 miles of breakwater on the bayside of the restored islands. Additional protection is provided to island complex by the addition of reef balls between the breakwater and island complex for the creation of 2.0 acres of oyster reef.

The breakwater and islands would protect SAV within Redfish Bay and it is assumed that approximately 200 acres of additional SAV will form between the breakwater and islands. The entire measure prevents island loss which provides protection to extensive seagrass meadows and support of coastal water birds. Figure 7-8 indicates potential sediment sources. A sediment volume of 6,685,556 cy would be required for island creation and restoration and can be mined from ODMDS 1.

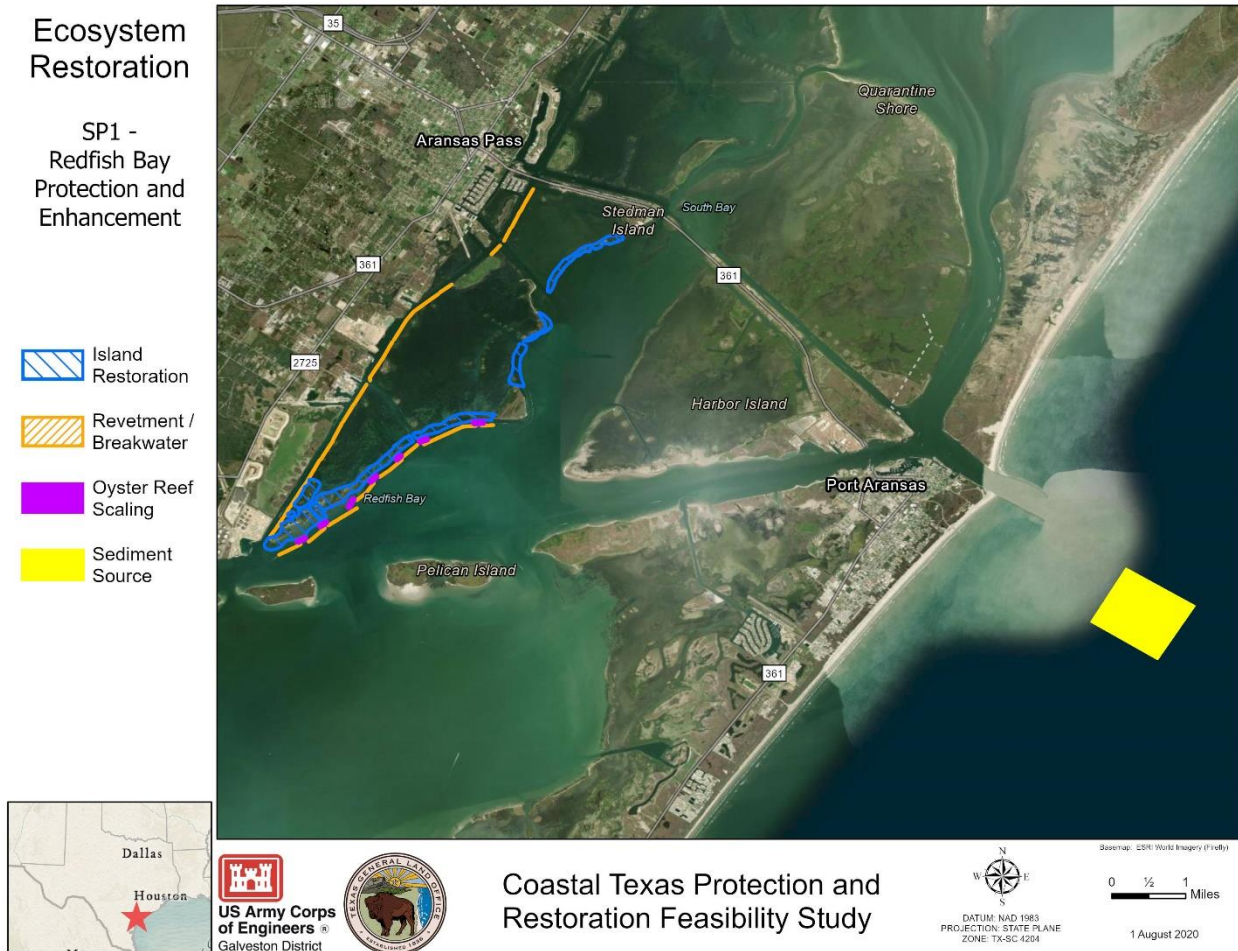

Figure 7-8: SP-1 – Redfish Bay Protection and Enhancement

7.9 W-3 – PORT MANSFIELD CHANNEL, ISLAND ROOKERY, AND HYDROLOGIC RESTORATION

This measure provides beach nourishment, island restoration, sediment management, shoreline protection and restoration utilizing breakwaters and provides hydrologic restoration.

The measure consists of three elements: (1) hydrologic connection between Brazos Santiago Pass and the Port Mansfield Channel by dredging of a portion of the Port Mansfield Ship Channel, which will provide for 112,864.1 acres of hydrologic restoration in the Lower Laguna Madre; (2) protection and restoration of Mansfield Island with the construction of a 0.7-mile rock breakwater and placement of sediment from the Port Mansfield Channel to create 27.8 acres of island surface at an elevation of 7.5 feet; and (3) 9.5 miles of beach nourishment along the Gulf shoreline north of the Port Mansfield Channel with dredged material as a minimally-worked swash zone placement. Footprints and sediment sources for the measure are indicated on Figure 7-9.

The Lower Laguna Madre is a hypersaline lagoon along the southern Texas coast offset from the Gulf of Mexico by Padre Island. The area is tidally connected to the Gulf of Mexico by the Brazos Santiago Inlet and Mansfield Pass. Limited freshwater inflow and evaporation conspire to generate hypersaline conditions. Saline inflow from the Gulf of Mexico acts to reduce the salinity in the lagoon. Shoaling in Mansfield Pass limits the inflows that help mitigate the hypersalinity.

King et al. (2018) conducted a study of shoaling in the Brazos Island Harbor navigation channel located at the Brazos Santiago Inlet. This study also included an evaluation of hydrodynamic conditions in the Lower Laguna Madre. They found that the preservation of the connection between the gulf and lagoon to have several ecological benefits including: reduction of salinity in the lagoon, additional flushing of pollutants from the lagoon, increased supply of fully oxygenated water to the lagoon, nutrient exchange between the two water bodies, and a mechanism for larval transport. Since Mansfield Pass is a smaller inlet than Brazos Santiago Inlet it acts as a choke point in the Lower Laguna Madre system; dredging the pass would reduce the hydrodynamic restrictions and promote more favorable conditions in the lagoon.

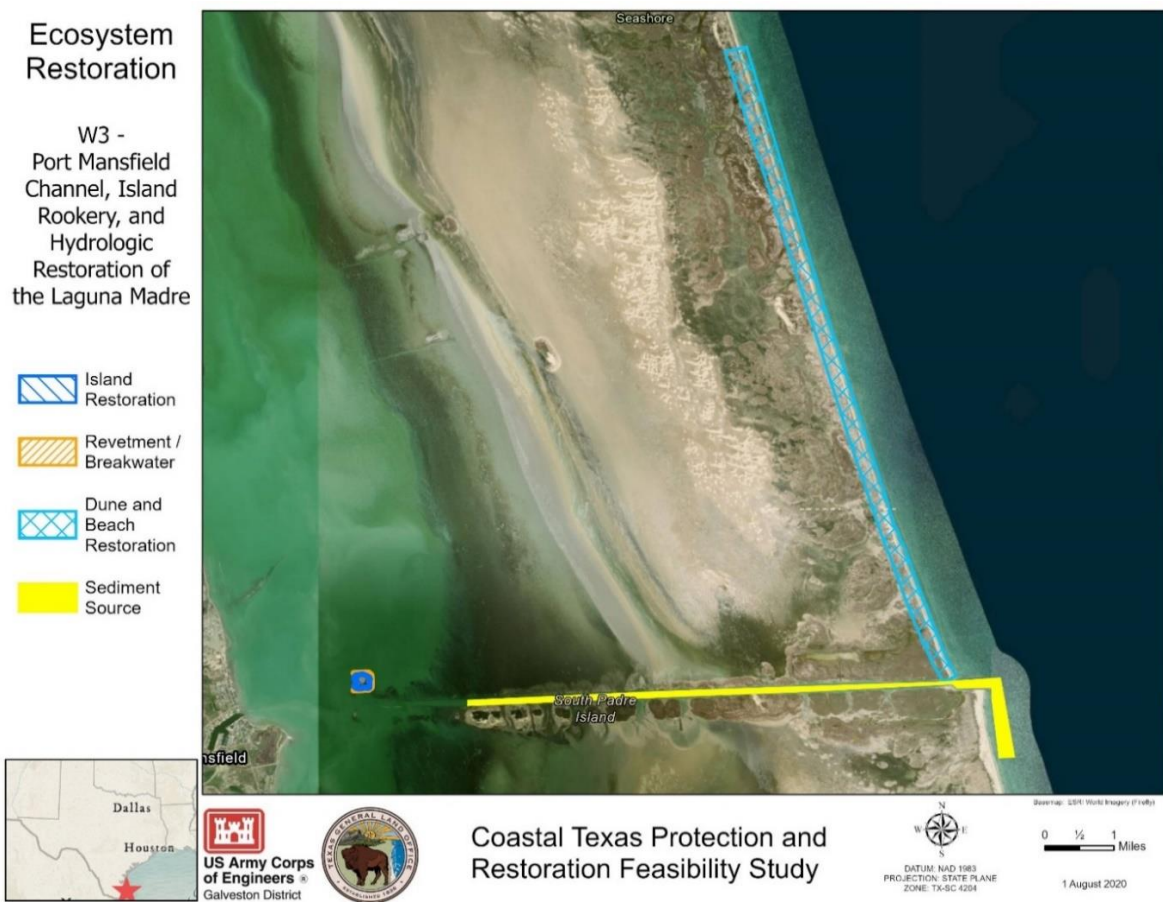

Figure 7-9: W-3 – Port Mansfield Channel, Island Rookery, and Hydrologic Restoration

7.10 INVESTIGATIONS AND ANALYSIS REQUIRED DURING PRECONSTRUCTION ENGINEERING AND DESIGN (PED)

The ER components in this feasibility study, including alternatives analysis and feasibility design, was completed using available data. There will be additional data and analysis requirements during PED which include:

Survey data will need to be collected in several areas. The existing elevations in the locations of project features were assumed based on discussions with the non-federal sponsor and local resource agencies.

Many ER features identify “possible sediment sources” that could be used for the marsh nourishment and island restoration features. These were not used in developing costs for each feature during feasibility but should be evaluated during PED. These possible sources were identified to replace assumed sediment sources if they are unavailable come construction. They were also identified based on regional sediment management principles and/or based on those that could have benefits beyond this project, e.g., to navigation.

Marsh cell boundaries will need to be refined based on the results of site-specific surveys and based on anticipated availability of O&M material for those features where BUDM is assumed.

8.0 SOUTH PADRE ISLAND (SPI)

The CSRSM plan also includes a feature along South Padre Island which would nourish the beach and dune along to reduce risks from coastal storm surge to businesses, residents, and infrastructure in the highly developed areas (Figure 8-1) (Details can be found in Annex 21. SPI has a long history of beneficial use of dredged material (BUDM) associated with maintenance dredging of the Brazos Island Harbor (BIH) navigation project. This addition of sand to the beach profile has been successful in reducing shoreline erosion. Beach-fx was used to evaluate this CSRSM feature.

The project area was delineated into six reaches based on geomorphic conditions and considerations associated with the economic analysis. Environmental forcing was based on historic storm climatology and the state-wide storm modeling completed as a part of this study. The without project shoreline erosion rate was estimated by artificially removing historic BUDM to not penalize the proactive measures of local authorities. This was used for Beach-fx calibration. Beach-fx is an engineering and economic model that does life cycle simulation of beach morphology and the associated damages. The model operates off a storm response database that is prepopulated with SBEACH outputs.

The analysis led to a recommended plan for beach and dune nourishment to maintain a 120 ft wide berm and a +12.5 ft (NAVD88). This is proposed along 2.9 miles of the developed shorefront areas of SPI (reaches 3 thru 5 in the analysis). Renourishment is proposed on a 10-year cycle for the project life of 50 years to maintain the CSRSM benefits. Continued beneficial use of dredge material from the BIH navigation project could also accomplish the design objectives of offsetting long-term erosion. The full details of the SPI CSRSM analysis are located in appendix E-2.



Figure 8-1: SPI Beach Nourishment Plan

9.0 OPERATION, MAINTENANCE, REPAIR, REPLACEMENT AND REHABILITATION (OMRR&R)

9.1 BOLIVAR AND WEST GALVESTON – OPERATION AND MAINTENANCE, REPAIR, REHABILITATION AND REPLACEMENT

The purpose of operation and maintenance, repair, rehabilitation and replacement (OMRR&R) is to sustain the constructed project over the 50-year duration. The cost estimates for maintenance of features on Bolivar and West Galveston was based on existing expenditures for normal O&M of similar features as listed in Table 9-1 below. The OMRR&R costs for Bolivar and West Galveston features are included in the Cost Engineering Chapter.

Table 9-1: Bolivar and West Galveston Beach and Dune OMRR&R Features

Feature/Reach	Dune (Miles)	Levee (LF)	Walkovers	Access Ramps	Drainage Structures
Bolivar Beach and Dune	25.1			48	5
Bolivar Levee		15,700		1	4
West Galveston Beach & Dune	18.4		58	18	35
Totals	43.5	15,700	58	67	44

The main features of work identified for the cost estimates for the dune and beach maintenance are identified below: Dune and Beach maintenance items include re-nourishment, re-planting, maintenance of sand fencing

- **Levee** maintenance items included yearly mowing of levees, semi-annual visual inspection of the levees; periodic establishment of turf, maintenance of access roads, and ramps.
- **Walkovers** maintenance items include repair/replacement of decking, hand railing, hardware
- **Access Ramps** maintenance items include grading and re-shaping, replacement of ramp material
- **Drainage structures** maintenance items included gate adjustments, gate rehab, clean-out of outfalls/trash tasks, and gate replacement.

Dune and beach re-nourishment methodology and cycles are discussed in Annex 2. The primary goal of the stochastic simulation was to determine the most effective renourishment rate. The limit state for rehabilitation is dune height reduction of 50% or more. This number was tracked throughout each storm. If exceeded, the beach, berm and dune profile was rebuilt to the original as-built profile prior to the next storm. A basic renourishment criterion of loss of half of the as-built dune height provided a heuristic optimized CSRM with relatively few periods where there was little to no flood protection while the

renourishment rate was roughly consistent with national average rates. As stated in the previous section, other limit state criteria were not necessary because there was relatively little net erosion of the beach and berm.

The number of rebuilds mean and mean+1 standard deviation over all life cycles were computed. Table 9-1 summarizes the rebuild statistics for all alternatives, profiles, and RSLC scenarios. The dune field required significantly fewer rebuilds than the single dune. The dune field is being rebuilt on a 5-10-year cycle, depending on the RSLC scenario, while the single dune is rebuilt on a 3.5 to 6-year cycle. The high RSLC condition required significantly more rebuilds than the low. The values are plotted in Figure 9-1. Table 9-3 summarizes re-nourishment volume (MCY) and rebuild frequency with RSLC. Management may decide to plan for an equal re-nourishment interval (~ 7 years) for Bolivar and Galveston for convenience if the RSLC condition is low. In high RSLC condition, management needs to plan for an equal re-nourishment interval (~ 5 years) for Bolivar and Galveston for convenience.

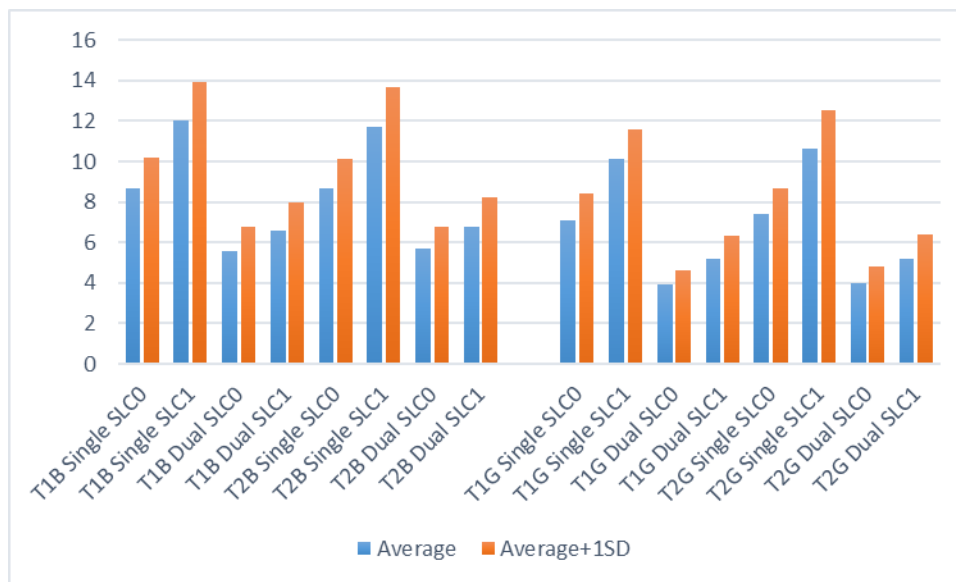

Figure 9-1: Number of rebuilds per 50-year life cycle, average and average+1 standard deviation. TB1 is, for example, XS1 Bolivar and T2G is for XS2 Galveston.

Table 9-2: Number of Profile Rebuilds for Various Profiles, Alternatives, and Scenarios

Alternative and Scenario	Number of Rebuilds per 50 years		
	Mean	Standard Deviation	Mean + Standard Deviation
Bolivar1 SINGLEDUNE USACE Low RSLC	8.7	1.5	10.2
Bolivar1 SINGLEDUNE USACE High RSLC	12.0	2.0	13.9
Bolivar1 DUNE FIELD USACE Low RSLC	5.6	1.2	6.8
Bolivar1 DUNE FIELD USACE High RSLC	6.6	1.5	8.0
Bolivar2 SINGLEDUNE USACE Low RSLC	8.7	1.4	10.1
Bolivar2 SINGLEDUNE USACE High RSLC	11.7	2.1	13.7
Bolivar2 DUNE FIELD USACE Low RSLC	5.7	1.2	6.8
Bolivar2 DUNE FIELD USACE High RSLC	6.8	1.3	8.2
Galveston1 SINGLEDUNE USACE Low RSLC	7.1	1.3	8.4
Galveston1 SINGLEDUNE USACE High RSLC	10.1	1.5	11.6
Galveston1 DUNE FIELD USACE Low RSLC	3.9	0.8	4.6
Galveston1 DUNE FIELD USACE High RSLC	5.2	1.1	6.3
Galveston2 SINGLEDUNE USACE Low RSLC	7.4	1.3	8.7
Galveston2 SINGLEDUNE USACE High RSLC	10.6	1.9	12.5
Galveston2 DUNE FIELD USACE Low RSLC	4.0	0.8	4.8
Galveston2 DUNE FIELD USACE High RSLC	5.2	1.2	6.4

Table 9-3: Re-nourishment Volume (MCY) and Rebuild Frequency with RSLC

Site	Total nourishment volume (MCY)	Total nourishment volume (MCY)	Total nourishment volume (MCY)	Rebuild Frequency	Rebuild Frequency	Rebuild Frequency
	Low RSLC	Int RSLC	High RSLC	Low RSLC	Int RSLC	High RSLC
Bolivar	12.751	14.28	15.81	7 years @ 1.822 MCY	6 years @ 1.785 MCY	5 years @ 1.581 MCY
West Galveston	6.57	7.85	9.14	8 years @ 1.095 MCY	7 years @ 1.04 MCY	7 years @ 1.305 MCY

UPPER TEXAS COAST SURGE BARRIER

The annual OMRR&R cost estimates developed for the Upper Texas Coast Surge Barrier includes:

- maintenance and staffing of an Emergency Operations Center (EOC) to provide command and control for emergency operations related to tropical event.
- the expense for staffing, training and stockpiling of typical flood fighting materials and equipment needed to respond to typical response events (i.e. heavy construction equipment including tractors, front end loaders, bulldozers, etc.), sandbags, plastic sheeting, etc.
- a trial operation of all gates and pumps. The cost associated with collecting Survey and instrumentation is also included in the OMRR&R estimate

The costs also include:

- Mowing of the grass cover and maintaining a vegetation-free zone a reliable corridor of access and permit proper inspection, manage pests, and inhibit weed encroachment to maintain the health and vigor of the grass stand.
- Cost for other essential maintenance activities include but are not limited to application of herbicides, fertilizers, irrigation, control animal burrows and undesirable (e.g. noxious weeds) vegetative growth as well as prevent unauthorized encroachments, grazing, vehicle traffic, the misuse of chemicals, or burning during inappropriate seasons along, levees, floodwalls, embankment dams, and appurtenant structures.

Additionally, the cost associated with Floodwall maintenance are crack repair, repair and replacement of cracked scour protection, waterstop repair and horizontal sealant at the wall joints. General floodgate (Roller, Swing, and Overhead Trolley) maintenance includes repairing damage or rusted areas, repair to galvanized surfaces, rubber gate seals replacement, etc.

The Bolivar Road and Offatts Bayou annual OMRR&R cost for the pump stations and large gates are based on scheduled inspection and periodic maintenance of individual features of the stations and gate complexes, including, but not limited to the electrical and mechanical equipment that are required to operate the station and the floodgate.

The cost associated many individual components of both the gates and pump stations have defined periodic maintenance intervals that will be further developed in the PED phase of this project. For instance, the pumps are required to be exercised on a set schedule and each exercise should last long enough to bring all systems up to normal operating temperature and allow for run-time inspections and

assessments. The gates are also exercised periodically, on a defined schedule and in accordance by the completed construction documents.

The above mentioned OMRR&R is to ensure the feature performs its intended purpose as expected when called on to perform during a tropical event. Estimates for routine maintenance and inspection occurring before, during and after hurricane season is included in the cost and will dictate the scope of the major repair work to be performed during an unwatering. Exposed structure and accessible machinery will undergo a more detailed inspection every five years with major de-waterings being done every 15 years. The steel gates are assumed to be constructed of carbon steel and thus periodic painting of these gates will be required. The large floating sections that comprise the Houston Ship channel closure are stored in a dry dock and thus most maintenance will be performed on site. The Vertical Lift Gates do not have a dry dock thus will be removed from the site (during non-hurricane season) and painted as required by previous mentioned inspections. The gates for the Shallow Water Environmental Gates are assumed to be stainless steel so it is no anticipated maintenance is expected, however, the estimates for this project include the cost of dewatering bulkheads that will allow the gate seals and other associated sluice gate components to be inspected. The dewatering costs in the inspection and any required maintenance of the bulkheads for all structures (Gates and Pump Stations)

The one area where the NFS not be obligated to OMRR&R is the flood proofing measures that constitute elevation of individual residential structures or construction of small ring berms around individual non-residential structures, on the west side of Galveston Bay.

The annual OMRR&R cost include cost for maintaining mitigation sites. The non-Federal sponsor would be responsible for OMRR&R of functional portions of sites as they are completed. On a cost-shared basis, the USACE would monitor completed mitigation to determine whether additional construction, invasive species control, and/or planting are necessary to achieve mitigation success. The USACE would undertake additional actions necessary to achieve mitigation success in accordance with cost sharing applicable to the project and subject to the availability of funds. Once the USACE determines that the mitigation has achieved initial success criteria, monitoring would be performed by the non-Federal sponsor as part of its OMRR&R obligations. If, after meeting initial success criteria, the mitigation fails to meet its intermediate and/or long-term ecological success criteria, the USACE would consult with other agencies and the non-Federal sponsor to determine whether operational changes would be sufficient to achieve ecological success criteria. If instead, structural changes are deemed necessary to achieve ecological success, the USACE would evaluate and take appropriate actions, subject to cost sharing requirements, availability of funding, and current budgetary and other guidance; as well as coordination with the local non-Federal sponsor and resource agencies.

9.3 GALVESTON RING BARRIER SYSTEM

OMRR&R of the GRBS system would be fairly extensive. The Recommended Plan is a complex system constructed partly in a marine environment. OMRR&R requirements would include, but not be limited to, annual exercising of all of the GRBS gates and closure structures, grass mowing of levee and floodwall right of way, painting of numerous metal surfaces, routine pump station O&M, drainage and navigation structure O&M and Section 408 type alteration approvals. The purpose of OMRR&R is to sustain the constructed project and to maintain the stated level of benefits at the completion of construction and throughout the project period. The local sponsors would also be required to coordinate with stakeholders for OMRR&R concerns and evacuation/emergency action planning. A majority of the annual OMRR&R costs are based upon sustaining the new flood wall system, O&M for the pump stations and the Offatts Bayou navigation structures. The NFS is not obligated to address loss of risk reduction due to RSLR through future levee lifts or structure modification, but they will still be required to repair, rehabilitation or provide replacement of components to maintain the original project benefits. As part of PED, an OMRR&R manual will be developed to outline the expected OMRR&R requirements. The GRBS OMRR&R includes, but not limited to:

- Annual exercising of all of the GRBS gates and closure structures.
- Yearly inspection of the entire system
- Painting of gates, structural panel evaluation and as needed replacement typically at 5-year interval. Annual inspection of pump stations.
- Routine O&M on pump stations. Major pump rehabilitation and machinery replacement typically at 15-year interval.
- Annual survey of riprap Scour protection of wave barrier with repair of rip rap typically every 5 years interval.
- Crack management of T-Wall, Combi-wall every 5 years.
- Rewiring the machinery system every 15-year interval.

9.4 ENVIRONMENTAL RESTORATION SYSTEM

The ER plan consisted primarily of breakwaters, island creation, shore protection, and beach nourishment that do not have out-year nourishment. Shore protection features are designed for 50-year using intermediate sea level rise condition. Unless there are needs for emergency repairs (e.g., collision with barge, scour hole), ER features are designed to last and perform for the intended 50-year project period. With this assumption, OMRR&R costs are excluded in all ER features

9.5 BOLIVAR GATE OPERATION

The gates are intended to remain open year-round to maintain continuous navigation and existing flow characteristics. The gates will be only be closed when a surge event is threatening the coast. The

decision to construct two smaller gates across Bolivar inlet in lieu of one large opening was, in part, to add resiliency to the system. After an event, if one of the gates has a problem opening, there will still be one lane open for navigation until the other gate is able to open. The sector gates across the ship channel are anchored and housed in man-made “islands” on either side of the HSC entrance channel. The gates will be stored in a dry dock within the manmade islands, which will help minimize the probability of vessel impacts while the gates are in the stored position. When it is time to employ the gate, the dry dock will be flooded allowing the gate to float into place and then water will be pumped in the sections of the gate allowing it to sink in place. Once the event has passed, the gate sections will be pumped out and the gate will be floated back to the dry dock.

As stated earlier, the Storm Surge Gate at Bolivar Roads will also include a central control/visitor center on the Galveston side of the barrier. Additionally, to assure redundancy in the operation of the gates, a 3,500 SF auxiliary operations center would be located on Bolivar on the bay side of the levee near the intersection of 23rd and State Highway 87. The facility would be at the same elevation as the Main Operation Center.

The surge gate operation will be depended on the intensity, track and orientation of the landfalling storm which will dictate trigger condition in the bay for gate closing. Pumps will be operated when intake water level are higher than the outfall. This expected rate of closure would be the same regardless of the actual rate of relative sea level rise, as closure of the system is tied to tropical storm events and the elevation trigger would be adjusted as sea level rises. The risk reduction system is only authorized to address storm surge caused by hurricane and tropical storm events. It is not authorized to mitigate for or reduce impacts caused by higher day-to-day water levels brought about by increases in sea level rise.

An operational plan will be completed in conjunction with the PED phase of the project. The plan will include the duration that gates will remain fully open at all times except during surge events, for short duration operational testing, and maintenance checks and inspections. The operational plan will also include direction on timing of closing and opening of gates as a storm approaches and passes. The operational plan shall include procedures to allow timely opening of gate structures. Sea level rise will increase the need for closures, if a constant vertical water level trigger is used to determine closures. However, once sea levels rise enough to cause this trigger to be exceeded more frequently, the likely plan is to adjust the threshold periodically (e.g. every decade), to track an annual exceedance probability (AEP) of either 50% or 10% (TBD). Preliminary research results for a constant water level trigger demonstrate how sea level rise could cause increases to the frequency and duration of barrier gate closures.

At this time, the return interval for storm surges high enough to threaten the project area has not been determined. Gates or water control structures would need to be closed for large storm events, even if the storms occur more frequently than the predicted return period. The operating plan for the gates has not yet been developed, but an estimated closure time (one to two day for each storm event closure or

up 12 hours for periodic maintenance) would result in only minor and temporary impacts to navigation. The details and schedule of these closures would be determined during preparation of the Operation Plan in consultation with other state and federal resource agencies. For reference, the following summarizes the operation criteria of major storm surge barriers across the World.

- The Thames barrier closes if water level forecast is above 4.87 m at London Bridge. The criterion is based on a combination of factors including forecast height of the tide and river flows. Met Office issues tidal alerts for areas around the coast against set trigger levels. If an alert is received for sheerness, depending on river flow the barrier closure procedures start without any further decision. The results of three models are combined to highlight the need for closure, taking into account forecast accuracy.
- Maeslant barrier: Closing criterion +3.0 m above sea level, based on forecast levels. During the storm season of 2007 the closing criterion of the barrier was reduced to +2.60 m above sea level because the barrier had never been closed since it became operational 10 years before. A water level of +2.60 m was forecasted in November 2007, leading to the closure of the barrier
- Hollandse IJssel barrier: Closing criterion +2.25 m above sea level, based on forecast levels
- Eastern Scheldt barrier: Closing criterion +3.0 m above sea level, based on forecast levels
- Hartel barrier: Closing criterion +3.0 m above sea level, based on forecast levels
- Venice barrier, MOSE: Closing criterion +1.10 m above sea level (reference level). Criterion can change whenever necessary based on forecast and measured levels.

9.6 RELOCATIONS

9.6.1 Pipelines and Utilities

Due to the prevalence of the petrochemical industry within the study areas, the projects cross or parallel, or will cross or parallel, numerous pipelines carrying various petroleum products. The proposed new systems also cross or impact existing infrastructure within the footprint of the project features to include electrical, water, sewer, and gas utility lines.

In most instances, existing pipelines and utilities that will cross beneath or through a planned risk reduction system, or be close to it, require relocation. This is because most pipelines are buried at a relatively shallow depth when surcharge loading is not anticipated, and leaving them in place could cause serious damage to and structural compromise of the levees or the utility line is within the area of a floodwall foundation or within the easement required for maintenance of the feature. The structural integrity of, and access to the pipelines and utilities can also be adversely affected by placement of a large surcharge load over them. The pipe strength may not be enough to withstand the added loading and pipe joints may be unable to accommodate movements resulting from foundation settlement. The foundation design for the floodwalls may also preclude allowing pipelines to remain in place. As a

general rule, pipelines beneath flood protection levees and floodwalls should be avoided altogether, particularly in the case of pressure lines.

When developing the features to a greater level of design detail/confidence, the necessity for pipeline and utility relocations will be re-evaluated. It may be that some pipelines can be allowed to remain in place within the levee foundation. In assessing this, the following principal items will be considered:

- Levee or floodwall height
- Duration of high-water stages against the levee
- Susceptibility to piping and settlement of levee and foundation soils
- Type of pipeline (low- or high-pressure line, or gravity drainage line)
- Depth of the pipeline
- Feasibility of providing closure in event of ruptured pressure lines, or in the event of failure of flap valves in gravity lines during high water
- Ease and frequency of required maintenance and access
- Cost of acceptable alternative systems
- Possible consequences of piping or failure of the pipe

Since all but a few of the pipelines crossed by the proposed new levee and barrier systems carry petroleum products and are buried at a relatively shallow depth, and given that their present condition and strength are unknown, the presumption will be that virtually all these pipelines will have to be relocated. Supporting this premise is that significant settlement and consolidation of the compressible foundation from the added levee surcharge load is expected will take place, which undoubtedly will greatly disturb/stress the pipelines embedded within it. The bottom of the concrete footings of the floodwalls will also be set a few feet below the existing grade and in some instances, batter piles may have to be driven for the foundation. Leaving the pipelines in place only increases the risk that the plan structures will eventually be structurally compromised.

9.6.2 **Pipelines and Utilities for the Recommended Plan**

Relocations or modifications for the pipelines and utilities crossing the CSRMM barrier alignment or near the alignment, and their associated costs, will be extensive. Essentially all the pipelines, if not all, will require relocation given their shallow burial depths and likely structural inadequacy to handle the greater overburden load, and because they will effectively serve as seepage conduits. Even under short-duration hydrostatic loading, seepage is a concern that needs to be examined. (Current requirement is that a steady-state seepage condition must be assumed for flood-damage reduction structures.)

Information on the pipelines and utilities crossing the barrier alignment was obtained from an oil and gas GIS database maintained by the TRRC and the City of Galveston Infrastructure database. This information for pipelines included the approximate location and orientation by coordinates, system and subsystem names, ownership, operator, diameter, product carried, and permit. However, it did not provide the pipeline depth. Because only a nominal amount of the project area is within USACE’s regulatory domain, no information on pipeline depths was immediately available that might have been included in as-installed permit records. At the time of this report the pipelines within a major corridor that crosses Clear Lake and Dickinson Bay is in the process of been relocated for the future expansion of State Highway 146 to the west and impacts to the projects features at these locations will be further developed during PED. Tables 9-4 through Table 9-9 below serve as a tabulation of pipelines and utilities for Bolivar, Gate Crossing, Galveston, and West Galveston.

Table 9-4: Pipelines and Utilities – Bolivar Dune System and Gate Crossing

Feature	Relocations	Quantity Impacted	Unit	Pipeline/Utility Notes
Bolivar Dune System	Enterprise Products Operating LLC - 24"	600	LF	
	Centana Intrastate Pipeline, LLC - 24"	600	LF	
	Pipeline-Natural Gas - 24"	600	LF	
	Underground Electrical	300	LF	Crosses combi-wall runs to Coast Guard Tower
	Raise Overhead Electrical Line @ Rettilon Rd	150	LF	Raise OH electrical eastside of Rettilon Rd
Gate Crossing	Boat Ramp Relocation	1	LS	Existing Jetty Boat Ramp

Table 9-5: Pipelines and Utilities – Galveston Ring Barrier System Waterlines

Feature	Relocations	Quantity Impacted	Unit
Galveston Ring Barrier System	Remove 12" Waterline	2110	
	Remove 10" Waterline	120	LF
	Remove 20" Waterline	140	LF
	Remove 30" Waterline	75	LF
	Remove 36" Waterline	75	LF
	Remove 30" Waterline	700	LF
	Remove 8" Waterline	600	LF
	Remove 8" Waterline	500	LF
	Remove 30" Waterline	200	LF
	Remove 20" Waterline	200	LF
	Remove 20" Waterline	2560	LF
	Remove 12" Waterline	750	LF
	Remove 6" Waterline	130	LF
	Remove 12" Waterline	270	LF
	Remove 8" Waterline	600	LF
	Remove 6" Waterline	170	LF

Table 9-6: Pipelines and Utilities – Galveston Ring Barrier System Sewers

Feature	Relocations	Quantity Impacted	Unit
Galveston Ring Barrier System	Remove 27" San. Sewer	230	
	Remove 10" San. Sewer	1700	LF
	Remove 12" San. Sewer	160	LF
	Remove 10" San. Sewer	180	LF
	Remove 30" San. Sewer	240	LF
	Remove 30" San. Sewer	240	LF
	Remove 42" San. Sewer	80	LF
	Remove 54" San. Sewer	450	LF
	Remove 24" San. Sewer	100	LF
	Remove 8" San. Sewer	470	LF
	Remove 10" San. Sewer	470	LF
	Remove 12" San. Sewer	100	LF
	Sanitary Sewer Manholes 3' to 10' Depth	54	LF
	8" San. Sewer	110	
	8" San Sewer Harborside Heliport	250	LF
	8" San Sewer Ferry Rd	100	LF
	Sanitary Sewer Manholes	7	LF

Table 9-7: Pipelines and Utilities – Galveston Ring Barrier System OH Electrical

Feature	Relocations	Quantity Impacted	Unit	Pipeline/Utility Notes
Galveston Ring Barrier System	Relocate OH Electrical Line with 11 poles	1100		
	Relocate OH Electrical Line with 2 poles	200	LF	Line along 3005
	Relocate OH Electrical Line with 2 poles	200	LF	Line along Stewart Rd South
	Raise OH Electrical/Relocate 1 Tower	1,000	LF	Line along Stewart Rd North
	Relocate OH Electrical Line with 3 poles	600	LF	Raise OH Electrical between I45 & Railroad
	Relocate OH Electrical Line with 4 poles	350	LF	Line within Perm footprint along railroad @ Harborside
	Relocate OH Electrical Line with 2 poles	200	LF	West of 77th St
	Relocate OH Electrical Line with 3 poles	300	LF	South side Harborside at 77th St
	Relocate OH Electrical Line with 8 poles	800	LF	77th St at Railroad
	Relocate OH Electrical Line with 8 poles	780	LF	Port Industrial @ Sulfur Facility
Relocate OH Electrical Line with 6 poles	700	LF	16th to 14th street	

Table 9-8: Pipelines and Utilities – Galveston Ring Barrier System Water Mains

Feature	Relocations	Quantity Impacted	Unit
Galveston Ring Barrier System	30" 59th	140	
	20" 59th	100	LF
	20" with Sewer Plant footprint	1020	LF
	30" Port	440	LF
	16" Port	70	LF
	20" Port	2000	LF
	12" Port	500	LF
	16" 21st	100	LF
	8" 20th	150	LF
	6" UTMB	100	LF
	6" Yacht Club	350	LF
	8" Ferry Rd	550	LF
	6" Ferry Rd	100	LF
	24" Natural Gas Pipeline	600	LF

Table 9-9: Pipelines and Utilities – Galveston Dune System

Feature	Relocations	Quantity Impacted	Unit	Pipeline/Utility Notes
Galveston Dune System	14" Crude Pipeline	600	LF	Gas line @ 7 Mile Rd
	Fiber Optic Cable	600	LF	Gas line @ 8 Mile Rd

9.6.3 **Pipelines in Vicinity of Clear Lake and Dickinson Bay**

Error! Reference source not found. and 9-3 show current pipelines in the vicinity of the footprint for the Clear Lake and Dickinson Bay navigation gate and combi-wall. The pipeline corridor continues south along Highway 146 and is a major source of product to the Texas City Petrochemical Facilities. It should be noted that the expansion of Highway 146 to 12 lanes is requiring the relocation of the pipelines within this major corridor and further impact to the features at Clear Lake and Dickinson Bay will be determined during PED. The pipelines are tabulated in Table 9-10 and Table 9-11.



Figure 9-2: Clear Lake Pipeline

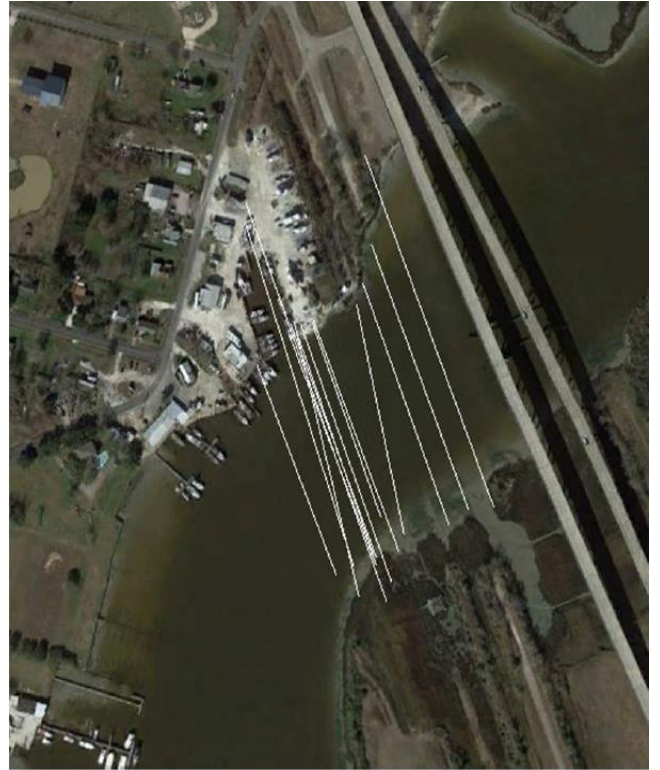

Figure 9-3: Dickinson Bay Pipelines

Table 9-10: Clear Lake Pipelines

Feature	Size (inch)/Type	Owner
Clear Lake	6" Propylene	ExxonMobil
Clear Lake	12" Gas	NuStar Logistics
Clear Lake	12" Pipeline	Magellan Pipeline Co
Clear Lake	6" Ethylene	UCAR Pipeline Incorp.
Clear Lake	Unknown	Enterprise Texas Pipeline
Clear Lake	12"	Seadrift Pipeline Corp
Clear Lake	Unknown	Lavaca Pipeline Co.

Table 9-11: Dickinson Bay Pipelines

Feature	Size (inch)/Type	Owner
Dickinson Bay	6" Propylene	Flint Hills Resources
Dickinson Bay	12" Gas	NuStar Logistics
Dickinson Bay	12" Pipeline	Magellan Pipeline Co.
Dickinson Bay	6" Ethylene	UCAR Pipeline Incorp.

Dickinson Bay	Unknown	Enterprise Texas Pipeline
Dickinson Bay	12"	Seadrift Pipeline Corp
Dickinson Bay	Unknown	Lavaca Pipeline Co.

9.6.4 Relocation Method

It is envisioned that all pipelines requiring relocation will be removed by mechanical excavation (i.e., trenching) and then reinstalled at a deeper depth by way of horizontal directional drilling, which is ideally suited for deep burial depths. Directional drilling is a reliable method of relocation and can be done prior to constructing the CSRМ feature. From a geotechnical perspective, the pipeline needs to be installed deep enough beneath the levee section and any berm sections to avoid stresses from levee and berm subsidence. The required depth and minimum distances from the levee/floodwall centerline of the pipeline entry and exit points will be investigated in future phases as the project details are further developed. However, it is expected that the relocated pipelines will have to be buried at a depth of at least 30 feet below ground at the structure centerline with entry and exit points at least 500 feet away from the centerline.

Utilities, such as water, sewer, and gas requiring relocation will be relocated by mechanical excavation and reinstalled outside of the feature right-of-way. Utilities crossing a project feature will have to be buried at a depth of least 30 feet below ground at the structure centerline. Overhead electrical lines crossing levees and floodwalls will be raised above the feature to meet code requirement or relocated outside of the feature right-of-way. Further investigation of pipelines and utilities will be conducted during PED.

9.6.5 Storm Drain Modifications

The construction of the Galveston Ring Barrier System will require the modification to major storm drain features that outfall along the Galveston Harbor Channel adjacent to Port of Galveston property. The drains would be modified with a closure gate to prevent storm surge from coming into the ring barrier system. Table 9-12 is a tabulation of storm drain modifications. Further investigations will be conducted during PED to identify any new or addition drains that would require modification.

Table 9-12: Storm Drain Modifications

Storm Drains			Location
48" RCP	1	Ea	77th
5'x3' box culvert	1	Ea	Port slip
6'x4' box culvert	1	Ea	Port slip
6'x5' box culvert	1	Ea	Port slip
8'x3' box culvert	1	Ea	33rd
72" RCP	1	Ea	29th
5'x4' box culvert	1	Ea	27th
6'x3' box culvert	1	Ea	26th
36" RCP	1	Ea	25th
8'x3' box culvert	1	Ea	24th
72" RCP	1	Ea	22nd
3'x5' box culvert	1	Ea	22nd
54" RCP	1	Ea	20th
6'x4' box culvert	1	Ea	19th
36" RCP	1	Ea	18th
24" RCP	1	Ea	16th
30" RCP	1	Ea	15th
10'x3' box culvert	1	Ea	14th
72" RCP	1	Ea	Harborside
7'x5' box culvert	1	Ea	UTMB
42" RCP	1	Ea	4th Street
54" RCP	1	Ea	Ferry Rd

10.0 COST ESTIMATE

This MII estimate was prepared for the Coastal Texas Protection and Restoration Feasibility Study (Coastal Texas Study) which was initiated in 2014 to evaluate large-scale coastal storm risk management (CSRM) and ecosystem restoration (ER) alternatives aimed at providing the coastal communities of Texas with multiple lines of defense from a wide array of coastal hazards.

The study area includes the entire Texas coastline extending from the mouth of the Sabine River at the Texas/Louisiana border to the mouth of the Rio Grande near Brownsville, Texas. This includes all 18 of Texas coastal counties. The study area was subdivided into three areas: the Upper Texas Coast, the Lower Texas Coast, and a coast-wide ER Plan.

All CSRM features are found in the Upper Texas Coast, except for one located in South Padre Island (SPI), which is found in the Lower Texas Coast.

The Recommended Plan was formulated as a system and includes several features that provide risk reduction through a line of engineered features along the gulf, other features to provide resiliency along the bay and future adaptations to sea level change. The plan features are described below.

- Bolivar Roads Gates between Bolivar Peninsula and Galveston Island is the largest feature of the Coastal Barrier system. It includes surge barrier gates that are made up of navigable floating sector gates and environmental lift gates and a combi-wall made up of vertically driven piles with a battered support pile and a reinforced concrete cap.
- The Galveston Ring Barrier System (GRBS) feature is a system of floodwalls, gates, pump stations, levees which connect to existing levee and seawall. In addition, there are combi-walls, environmental lift gates, and vertical lift gates at Offatts Bayou. Seawall Elevation is a future adaptation to provide for a continuous barrier for storm surge reduction along the gulf coast.
- Bolivar and West Galveston Dune and Berm Construction and Renourishment are a critical component of the comprehensive plan for coastal storm risk reduction along the Texas Coast, and they tie into the storm surge gate and ensure its function over time.
- Clear Lake and Dickinson Closures and Pumping Stations on the mainland reduce residual risk from bay flooding.
- A beach restoration project on SPI.
- Ecosystem Restoration measures are proposed at eight locations along the coast and include the following: 802 acres of breakwaters, 848 acres of bird islands, 2,052 acres of marsh, 44 acres of oyster reef, and 2,513 acres of dunes/beaches.

- Region 1 Mitigation measures include: 1302 acres of estuarine wetland located at seven sites, 161.8 acres of freshwater wetlands comprised of 34.4 acres of wetland and 127.6 acres of prairie buffer, and 130.5 acres of oyster reefs.

Engineering design work is premised on feasibility-level detail and analyses, consistent with the SMART planning process that is necessary to substantiate the Recommended Plan baseline cost estimate. Another key concept is to utilize existing information where applicable. Quantities and design features were developed by the Galveston District (SWG) Engineering Branch and the New Orleans Structural Branch.

This estimate was prepared using the latest Unit Price Books and labor rates for fiscal year 2020 (October 2019). The MII was organized into three areas. Each area was subdivided into the features, and each feature was subdivided into Non-Federal and Federal Costs and then into the work breakdown structure. The midpoint date of each account code for each of the construction contracts was used to develop the fully funded costs. The estimate was prepared in accordance with ER 1110-2-1302. The estimates were based on standard operating practices for the Galveston District which assumed conventional contracting practices of large business IFBs [see Annex 22 to review the Total Project Cost Summary Sheets (TPCS) for the Recommended Plan).

10.1 CONTINGENCIES

A formal Cost Risk Analysis was performed with the cooperation of the PDT and Cost Engineering Directory of Expertise (DX) of the Walla Walla District in June 2020. The risks were quantified, and a cost risk model developed to determine a contingency at 80% confidence level (CL). The new contingencies, along with the estimates, were input into the TPCS.

The costs were escalated in accordance with the Engineering Regulation and EM 1110-2-1304 to mid-point of construction.

10.1.1 Account Code 01 -- Lands and Damages

The Galveston District Real Estate Division developed costs for Lands and Damages.

10.1.2 Account Code 02 – Relocation

This account was separated into three different subgroups:

Utilities: Consisted of an assortment of water lines, sewer line, underground electrical lines, and overhead electrical lines.

Pipelines: This item refers to pipelines that require relocation. It was assumed that the relocation of the pipelines would be performed by directional drilling. Those costs were based on quotes from pipe

suppliers with the costs of hydrostatic testing, welding and layout, and making tie-ins based on quotes from pipeline contractors.

Structures: This is a catch-all category used when the items did not fall into one of the above mention categories. This category includes road ramps and pedestrian walkovers (if permitted) and boat ramps.

10.1.3 **Account Code 06 – Fish and Wildlife Facilities (Mitigation)**

Three different mitigation types were costed for the Upper Texas Coast. They were the following:

Estuarine Wetland: There are a total of seven (7) locations ranging in size from 4 to 667-acre sites. The sites would be constructed with dredge material from the Bolivar Roads crossing. Included in the cost estimate are the following: temporary containment berms and drainage structures to reach a final elevation of +0.7 to +1.1 NAVD 88 GEOID 09) with 20% open water and initial spartina seeding. In Target Year (TY) 4-5, re-seeding Spartina; TY 5 creating sinuous circulation channels and ponds using marsh buggies to compress soil; and TY6 re-seeding/planting 10% of spartina.

Palustrine (freshwater) Wetland: This site is located on Galveston Island and consists of restoring dunal swale wetlands by excavating material where necessary to bring it within 1-foot of the winter water table. Each tract would need a piezometer installed and monitored for a minimum of two (2) years to establish seasonal water tables. The area would be treated with prescribed burns to remove invasive vegetation and would be replanted with locally sourced wetland and prairie plant species.

Oyster Reefs: Three (3) location were identified for the creation of reefs. Reef construction would consist of the following: initial /final hydrographic surveys used for quality control; and ½” to 3” gradation crushed limestone that would be used for 9” of settlement at 6” minimum above bay bottom.

The design features were provided by SWF Planning and & Environmental Branch. Quantities were developed by SWG. Yearly monitoring and report of the overall condition of plantings and the marsh will be done every ten (10) years after construction for the duration of the project life.

10.1.4 **Account Code 10 – Breakwater and Seawall**

This code is found in the Galveston Ring Barrier System (GRBS) feature.

Breakwater: SWG Engineering Section provided the quantities for this feature. It was assumed the contractor would need to dredge an access channel in order to place the riprap, which ultimately creates an offshore breakwater to mitigate the wave impacts along the residential area and industrial area of Galveston Island.

Seawall: SWG Structural Engineering Section provided the quantities for this feature. The proposed Seawall raising is an extension of the north sheet-pile cutoff wall located at the north edge of the north

sidewalk. This extension is a 3 ft vertical wall that would have openings for vehicle and pedestrian access. The extension would go from Ferry Road to the west tie-in of the GRBS with a road raising at 89th Street to allow for continued access to the west end of the Island.

10.1.5 **Account Code 11 – Levees and Floodwalls**

SWG General Engineering and Structural Sections provided all quantities for the work.

Levees: SWG provided earthwork quantities for the levees located on Galveston Island and Bolivar Island. It was assumed that material for construction of the earthen levees would be provided from commercial borrow pits. Quotes for delivery to the jobsite were obtained for each of the geographic locations. The Bolivar levee would have a 30-mile haul. An assumed 20% swell factor was used for hauling. Other miscellaneous items include clearing, grubbing, and stripping the area, as well as hydro seeding with mulch and fertilizer. The levee will consist of a 1V:3H slope on the protected side and a 1V:6H slope on the unprotected side. The unprotected side of the levee will be armored with stone protection and the remainder of the levee will be turfed.

Floodwalls: Work for this feature will be found in Galveston Ring Barrier and Clear Lake features. SWG provided all quantities for the work. It was assumed that backfill for construction of the floodwall would be provided from commercial borrow pits 20 miles away. The material would require moisture control and the majority of this processing would be done at the borrow site area prior to bringing to the levee. A dozer and tractor would process/perform moisture control work. Trucks will haul the material to the construction area. Dozers and rollers will be used to spread and compact.

Backfill-spread and Compact Fill Material. Assumption: backfill, additional 4 ft., over wall heel and toe, levee-spread and compact, levee fill material, 95% compaction standard, 12" lift. These folders included are: Sheet Pile Cutoff using PZ-22 steel sheet piles, 22'; Structure Concrete Piles: using 16" square prestressed concrete piles (PCP), 64' long, with 3 piles every 5'; and Concrete. The concrete folder includes reinforced slabs, reinforced walls, and stabilization slab (4"). Other miscellaneous items included clearing, grubbing, and stripping the area, as well as hydro seeding with mulch and fertilizer and scour protection of 6" reinforced concrete slab (3,000 psi).

10.1.6 **Account Code 12 – Navigation Ports and Harbors**

This code of account will be found in Bolivar Road Crossing and Galveston Ring Barrier.

Included are costs for dredging new work material. Also included under this account code is the cost of Navigation Aids that the Coast Guard will need for the new alignment.

At Bolivar Road Crossing 14.8 MCY of new work material will be dredged. Most of this material is associated with access channel, gate foundation/sill, and new channel. The majority of the dredging

(14.4 MCY) will be done by hopper dredge. In addition, Anchorage Basins A and D will require 12 MCY to be dredged. Approximately 6 MCY of Anchorage Basin D will be hydraulically dredged, pumped into scow barges, and transported to specify location for Measure G-28. Only the dredging of this material will be included as a CSRM cost. The remaining 6 MCY of Anchorage Basin D will be dredged using one large-sized hopper dredge with disposal in the ODMDS 1 placement area. All turtle protection features (trawlers, endangered species observers, and monitoring surveys) for hopper dredging of Anchorage Basin D is included in this account code.

Galveston Ring Barrier includes costs for pipeline dredging of access channel for the break water and Offatts and Crash Basin access channels. Dredging costs were based on CEDEP estimates and quantities and soil characteristics provided by Galveston District (SWG) Engineering Branch.

Also included under this account code is the cost of 12 fixed mooring system at the Anchorage Basin “D”.

10.1.7 **Account Code 13 – Pump Stations**

Costs are found in Galveston Ring Barrier, Dickinson Bay, and Clear Lake. Cost for the different pump stations were developed using the cost estimates developed from Mott MacDonald (A-E). They developed the cost for Dickinson Bay and Galveston Island. The pump design for Clear Lake was developed by the Structural Section in Galveston District. In addition, dredging an access channel is included for the Clear Lake and Dickinson Bay.

10.1.8 **Account Code 15 – Floodway Control-Diversion Structure**

These costs are found in Bolivar Road Crossing, Galveston Ring Barrier, Clear Lake and Dickinson Bay. The cost for the Dickinson Bay, and the Offatts Bayou Vertical Lift Gates were developed by Mott MacDonald. Cost for Clear Lake, the remaining gates and combi-wall at Offatts Bayou, and the Bolivar Road Gates were based on designs from New Orleans District, Structural Section.

Cost were derived from similar work done by the New Orleans district with the dimensions and quantities adjusted to align with the width and size prescribed for this study. Different structures to be found in this code of accounts are the following: combi-walls; shallow water environmental gate; vertical lift gates at minus 20 ft. sill elevation; vertical lift gate at minus 40 ft. sill elevation; 125 ft. sector gate with sill at minus 40 ft.; and a 650 ft. opening floating sector gate.

In addition, the cost includes a central control/visitor center on the Galveston side of the barrier. The 5,000 square foot building would be located on Government owned lands and would be accessible via the construction of a 0.32-mile all-weather concrete road. To assure redundancy in the operation of the gates, a 3,500 SF auxiliary operations center would be located on the Bolivar side.

10.1.9 **Account Code 17 – Beach Replacement**

This code of account will be found in the Bolivar Island and West Galveston Island features.

Beach and Dune placement: Costs in this account code include all labor and equipment to construct beach and dune feature using beach quality sand obtained from the Sabine and Heald Bank offshore sand source. This source is approximately 40 miles offshore with a water depth of 40-50 feet and will be used for both initial construction operations and renourishment activities. Dredging is assumed to be performed by one large-sized hopper dredge and one medium-sized hopper dredge with hookup to barge-mounted booster pump and pumped to shoreline. As material is pumped, a combination of track dozers and excavators on beach will move pipe and shape material into required construction template. All turtle protection features (trawlers, endangered species observers, and monitoring surveys) for all hopper dredging is included in this account code. Quantities were provided by H&H Branch.

Beach Ancillary Measures. The cost was subdivided by Coastal Barrier Resources Act (CBRA) and Non-CBRA zones. Included in the cost are the following: dune vegetation, sand fencing, dune walkovers (pedestrian walkovers), ramps, and drainage structures (these quantities were provided by H&H Branch). A further description of these features can be found in Section 5.0 Civil Design of this report.

10.1.10 **Account Code 18 -- Cultural Resources Preservation**

Cost for this account code was developed by the archeologist in SWF, Environmental Section, Planning and Environmental Branch.

10.1.11 **Account Code 19 – Buildings, Grounds & Utilities**

This code of account will only be found in the West Galveston Bay Non-Structural features. It is the cost associated with raising certain structures situated East of Highway 146 from San Leon, North to Morgan's Point. Quantities and type of structure were provided by the economist.

10.1.12 **Account Code 30 -- Engineering and Design**

The cost for this account was developed using the guidelines provided in the TPCS, with the agreement of the cost engineer and the project manager. Costs are based on historical workload patterns and internal charges for the district.

10.1.13 **Account Code 31 -- Construction Management**

Costs for this account code were developed using the guidelines provided in the TPCS, with the agreement of the cost engineer and the project manager. Costs are based on historical workload patterns and internal charges for the district.

10.2 **NER FEATURES**

10.2.1 **Account Code 01 -- Lands and Damages**

The Galveston District Real Estate Division developed costs for Lands and Damages.

10.2.2 **Account Code 06 – Fish and Wildlife Facilities**

Costs in this account code include all labor, equipment, and material costs associated with the construction, delivery, and installation of reef balls revetment for Measures G-28, B-12, CA-5, M-8, & SP-1.

10.2.3 **Account Code 10 – Breakwaters and Seawalls**

Costs in this account code include all labor, equipment, and material costs to procure and install blanket stone, riprap, and geotextile base fabric, as well as mining of the GIWW using a pipeline dredge for creation of earthwork breakwater foundation. All earthwork (dredging, transporting, placing, shaping, and compacting) for breakwater foundation assumed to be completed by sub-contractor. Design of breakwater assumes inclusion of type class-C riprap with a gradation of 50 – 1000 LBS and median size of 250 LBS. Cost estimate assumes delivery of riprap and blanket stone from a rock quarry in Missouri with transportation by barge. Breakwater construction is included in Measures G-28, B-12, CA-5, CA-6, M-8, SP-1, & W-3.

10.2.4 **Account Code 11 – Levees and Floodwalls**

Costs in this account code include all labor, equipment, and material costs for construction of island restoration features for Measures G-28, M-8, and SP-1. For Measure G-28, all required material will be dredged from Anchorage Area D, as mentioned above, with only the transportation and placement of material included as NER costs. Material will be transported via scow barges, excavated using barge-mounted excavators, and shaped into design template by track dozers.

For Measure M-8, material will be excavated via pipeline dredge from PA 8 by breaching the containment levee, moving dredge along inside of PA, and mining available material. Material will then be pumped via pipelines and shaped into design template by track dozers.

For Measure SP-1, assumed one-third of required material will be obtained from beneficial use of shoaling in the Corpus Christi Ship Channel and LaQuinta Channel with the remaining two-thirds obtained from mining the aforementioned ship channels. Dredging of shoaled material to be performed by pipeline dredges and multiple booster pumps with an assumed maximum pumping distance of 10 miles and average pumping of at least 6 miles required. Costs to dredge shoaled material and pump to nearby placement area was removed from total costs as this is an O&M USACE function. Dredging of the remaining two-thirds to be performed by a pipeline dredge and booster pump with an assumed

maximum pump distance of 5 miles and average pumping of at least 3 miles. Assuming mined material from the aforementioned channels will largely consist of compacted sands and stiff clays with minimal loose silty-sandy material expected. Material will be hydraulically pumped to island restoration sites and placed and shaped into design template by dozers and excavators on pontoons and from barges as required.

For Measure W-3, material will be hydraulically dredged from the Lower Laguna Madre and pumped a maximum of 5 miles with average of 3.5 miles to specified island restoration site.

Additionally, costs to deliver and place Articulated Concrete Block Mats on slope shore face are included for each aforementioned measure. Quantities were provided by SWG, Engineering Branch.

10.2.5 **Account Code 12 – Navigation Ports and Harbors**

Costs in this account code include all labor, equipment, and material costs for construction of proposed marsh restoration sites by hydraulically dredging and pumping shoaled material from federal navigation channels. The estimated Operation & Maintenance cost to dispose of this dredge material in typical upland disposal areas was subtracted from the total cost to represent the incremental costs to pump material to the marsh cells. Additionally, costs to create containment dikes via barge-mounted clamshell draglines by excavating in-situ was included. For Measures G-28, B-12, and M-8, marsh fill material will be obtained from dredging shoaled GIWW material, while fill for CA-6 will be obtained from dredging shoaled Matagorda Ship Channel material.

10.2.6 **Account Code 17 – Beach Replacement**

Costs in this account code include all labor and equipment to construct beach and dune features using beach quality sand. For Measure B-2, Follets Island, sand will be obtained from the Sabine and Heald Bank off-shore sand source, approximately 40 miles offshore with a water depth of 40-50 feet, using one large-sized hopper dredge. As material is pumped, a combination of track dozers and excavators on beach will move pipe and shape material into required construction template. All turtle protection features (trawlers, endangered species observers, and monitoring surveys) for all hopper dredging is included in this account code.

For Measure W-3, Mansfield Island, sand will be obtained from the Lower Laguna Madre via one 24” pipeline dredge and pumped to beach using a minimally-shaped swash zone placement.

10.2.7 **Account Code 18 -- Cultural Resources Preservation**

Cost for this account code was developed by the archeologist in SWF, Environmental Section, Planning and Environmental Branch.

10.2.8 **Account Code 30 -- Engineering and Design**

The cost for this account was developed using the guidelines provided in the TPCS, with the agreement of the cost engineer and the project manager. Costs are based on historical workload patterns and internal charges for the district.

10.2.9 **Account Code 31 -- Construction Management**

Costs for this account code were developed using the guidelines provided in the TPCS, with the agreement of the cost engineer and the project manager. Costs are based on historical workload patterns and internal charges for the district.

11.0 **RISK AND UNCERTAINTIES**

This section summarizes risk and uncertainty included in some key models and methods applied in this study and documented in the report.

11.1 **LIMITATION IN H&H MODELING**

11.1.1 **Rainfall**

Rainfall is not included in the analyses as local drainage improvements were outside the scope of the project purpose, and there are existing project and authorities to address rainfall damages associated with riverine flooding. The proposed risk reduction system is only authorized to address storm surge caused by hurricane and tropical storm events. Rainfall events still cause significant flooding of the upland areas and within the enclosed area, however the system is designed to not make the rainfall situation worse. When the system is not in operation, all drainage features through the system were sized to match the existing capacity of the gravity drainage system and would mimic the existing drainage patterns when the system is not closed.

11.1.2 **Surge Modeling Limitation**

Current probabilistic modeling does not account for gate operations. Hydrodynamic simulations are done considering surge barrier in closed condition irrespective of any gate operation criteria (e.g., track orientation, SWL trigger). Gate closed condition was applied for the entire duration of any synthetic storms. As a result, inducements, especially at low return periods and with adverse storms tracks (e.g., East-West track) are observed which we are convinced are an artifact of the gate operation limitations in the current study. An operational plan needs to be developed in future phase of the project. The plan will include the duration that gates will remain fully open at all times except during surge events and for short duration operational testing, and maintenance checks and inspections. The operational plan will also include direction on timing of closing and opening of gates as a storm approaches and passes. The operational plan shall include procedures to allow timely opening of gate structures.

11.1.3 **Optimization of Beach and Dune System**

We understand that during extreme events such as events like hurricane Ike, proposed dune field of 14 ft high will be breached and likely generate residual flood depths in adjacent area. The residual flood risk due to overtopping has not been investigated in the current analyses. Given the nature of the development in Bolivar and West Galveston, where houses are pile supported and raised (Typically ground floor elevation are above BFE or + 17 ft), it is anticipated that residual flood risk due to breaching of dune and overtopping will be nominal and manageable. During extreme events (e.g., great than 50-year return period or 0.5% AEP), it is likely that these overtopping volumes will generate adjacent street flooding and ultimately absorbed by the large water body in East and West Bay. One solution is to go

with higher protection height (e.g., +17 ft) which was initially proposed for the initial tentatively selected plan. But during stakeholder's engagement, it was recommended to mimic existing/natural condition as much as possible. As such, the team had to find an optimum solution balancing performance and acceptability. However, PDT will conduct a detailed risk assessment in accordance with ER 101 during future phase of the study (PED) to optimize dune field in light of the residual flood risk and management strategy in the event of dune breaching and overtopping during rare events. PDT also recognizes the value of fortified dune system which may be considered in some vulnerable sections during PED phase when the systems are optimized.

11.1.4 **Sediment Budget**

The Bolivar and West Galveston Beach and Dune System includes approximately 43 miles of beach nourishment. The fillet adjacent to the Galveston Entrance Channel jetty is an accretionary area with some of the highest accretion rates on the Texas Coast. The expectation is that this trend would continue without project implementation and likely be accelerated with project implementation given the prevailing longshore transport. No quantitative work was done to determine the extent of expected with-project accretion, though additional analysis can be done during PED to make an estimate. Feature design during final feasibility considered cross-shore transport based on coastal storm forcing with the primary purpose of establishing CSRMM benefit. Regional modeling which includes day-to-day wave forcing to simulate longshore transport would better approximate anticipated accretion rates. The CSRMM feature is predicated on having the design beach and dune in place when a storm surge event occurs. For the purposes on simplicity during final feasibility design, the design profile was not altered along the alignment. If regional modeling were to estimate excessive accretion at the jetty fillet similar modeling could establish a scheme that provides variable nourishment based on the anticipated with-project sediment budget.

11.1.5 **Optimization of Galveston Ring Barrier System**

The crest height for the entire GRBS system has been proposed to be at 14 ft NAVD 88 with limited local wave transformation and overtopping analyses using existing bathymetry and topography which is subject to optimization during PED. Note that offshore breakwaters are lately recommended to reduce the wave energy during storm events to mitigation part of the residual risk. However, the size, extent, and orientation of these detached breakwaters have not been fully investigated to optimize the integrated system. Currently these breakwaters are kept as placeholders to further investigate natural (e.g., reef balls, archipelago) or structural (e.g. break waters) solution to further reduce wave energy in Galveston channel. These will be considered during optimization of GRBS crest height.

11.1.6 **Compound Flooding and Sizing of Pumps**

The primary purpose of the project is to prevent inland flooding from surge events during hurricanes, however most surge events are coincident with rainfall events. Measured tide data at NOAA-8771013

(Eagle Point) and measured daily rainfall data at USC00414333 (Houston National Weather Service Office), the peak daily water level and daily rainfall was plotted and is shown in Figure 11-1. Based on this figure, the peak historical surge event (Hurricane Ike) experienced a greater than 50-year surge, however it coincided with less than a 10-year rainfall. Similarly, the peak historical rainfall event (Hurricane Harvey) experienced a greater than 50-year rainfall, however it coincided with less than a 10-year surge. As can be seen by looking at Figure 11-1 the upper righthand corner of the graph is empty, demonstrating it is reasonable to conduct the evaluation assuming there is a relationship between surge and precipitation events, but not coincidence. As such, it was determined that while extreme precipitation may occur during extreme surge events it is unlikely that a 100-year precipitation event would be coincident with at 100-year surge event. Using judgment, PDT agreed that the pump capacity would be designed for the 10 to 25-year rainfall condition, assuming that this rainfall would conservatively correspond to the 100-year surge during which the navigation gates would be closed, and the pumps would be solely responsible for draining the watershed. This design condition is similar to that adopted for the West Closure Complex in New Orleans, LA, which based the pumping rate on a 10-year precipitation return period.

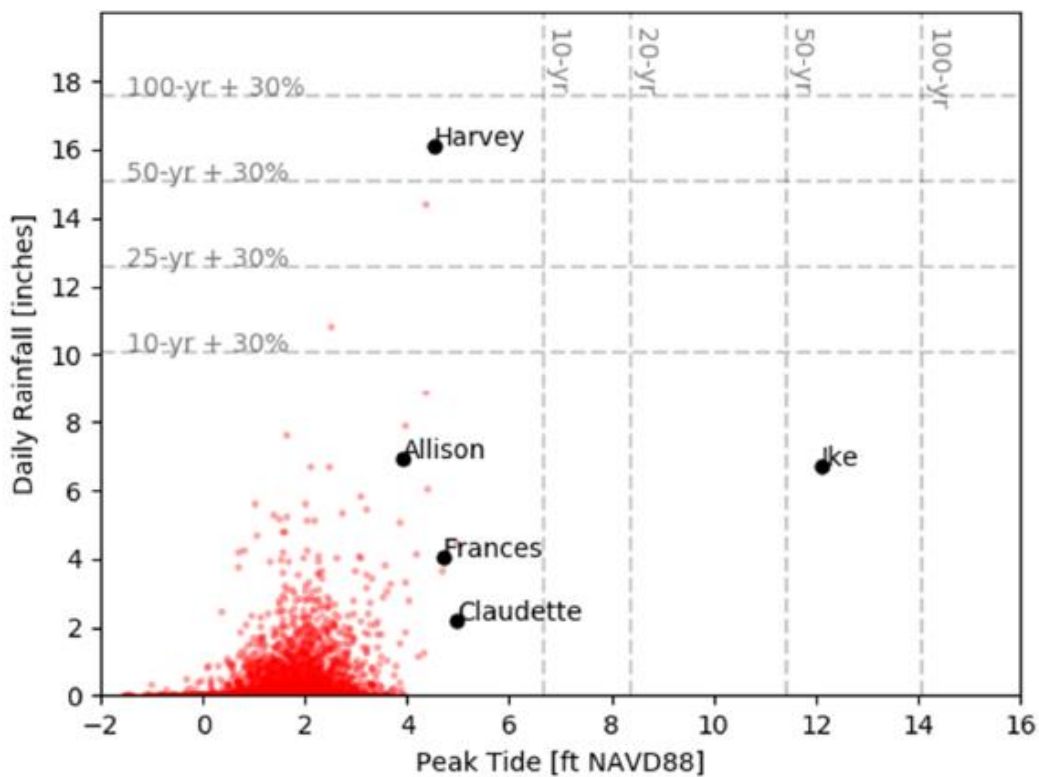

Figure 11-1: Peak daily water level at NOAA-8771013 vs. Daily Rainfall at USC00414333

However, while pumps are designed to handle 10 to 25-year rainfall with surge tail water boundary conditions are set independently corresponding to SWL at 1% AEP with 90% CI, the dependence of rainfall and surge have not fully explored in this phase of the study. The drainage analysis conducted in

this study is highly dependent on historical rainfall and surge data. The analysis assumes that the peak rainfall and overtopping events coincide, and that the gate structure must remain closed the full duration of the storm event. To further refine and potentially reduce pump sizes, a Joint Probability Analysis (JPA) should be conducted correlating rainfall and surge events. It is anticipated that this process would be similar to the standard JPM-OS analysis that is currently conducted to determine extremal storm surges. Conducting this analysis could refine the design pump and conduit sizes and potentially reduce project costs.

11.1.7 **Relative Sea Level Change**

This study uses current USACE sea level change guidance as required for USACE studies. To account for the unknowns in sea level change, USACE requires evaluation of high, medium, and low scenarios of sea level change projections. Recommendations to address RSLC scenarios are described in detail in the engineering appendix and summarized here. The Bolivar Road Surge Barrier, improvements in sea wall, Clear Lake and Dickinson closure system are designed high enough that there should not be concern of being impacted by RSLC estimates. However, dune field along Bolivar and West Galveston, levees and flood walls along the GRBS should be constructed in an adaptable or anticipatory manner for estimated sea level rise if possible. This project followed required USACE guidance for RSLC. Uncertainty is considered by evaluating a range of possible sea level change possibilities from “low” to “high.” It is recommended that RSLC be reevaluated during PED because the understanding of sea level change and USACE guidance may change between the completion of this report and initiation of PED.

11.2 **LIMITATIONS IN GEOTECHNICAL INVESTIGATION**

The actual foundation cost will be within the acceptable study level cost estimate based on the assessment of risk associated with the uncertainty of subsurface conditions. The summary of the subject risk assessment as follows:

11.2.1 **Surge Barrier System and Ring Levee System**

Seven deep soil borings, including geotechnical laboratory testing data, are available within the vicinity of the Surge Barrier System. A fair number of soil borings and CPTs are available along the alignment of the Ring Levee System, which is considered adequate for a feasibility level design.

The potential risk level related to feasibility study level geotechnical design can be classified as medium due to the nature of the deep foundation system and size of the project.

The following risk mitigation strategies were considered in the feasibility level geotechnical design:

- a) The lower- bound soil strength data was adopted from available soil borings within the vicinity of the proposed structures for axial pile capacity estimate and to estimate the design length of piles
- b) The upper bound strength value of the soils was considered in pile type selection and evaluation of pile drivability and potential hard-driving conditions during pile installation.
- c) Lateral pile resistance of the structures was designed based on battered piles included in the pile group system (pile cap supported by vertical and battered piles). The potential lateral resistance contribution from the vertical piles included in the pile group system was ignored in the group pile system's total lateral capacity.
- d) Sensitivity analysis using upper - and lower - bound geotechnical parameters for pile foundation design were performed to estimate the potential change in pile length and its impact on the project cost estimate.

Based on the considerations described above, feasibility level design lengths and required number of deep foundation piles are anticipated to be conservative (longer) compared to final design lengths and numbers determined during PED. Feasibility level design pile lengths and numbers will be optimized by obtaining comprehensive level geotechnical investigation data during PED. Lateral resistance of the vertical pile will be evaluated during the PED phase based on comprehensive level Geotechnical data. The additional lateral resistance contribution from the group of vertical piles may reduce the number of vertical piles.

11.2.2 **Beach and Dune System**

A fair number of soil borings and CPTs were drilled along the Bolivar Peninsula Beach alignment & West Galveston Island alignment during the feasibility phase of the study. The available geotechnical data is adequate for a feasibility level design. Therefore, the potential risk level related to developing geotechnical parameters for shallow foundation system can be classified as low due to the nature of the shallow foundation system.

11.2.3 **Deep Pile Driving**

Proposed deep foundation system for CSRMs features, including Surge Barrier (as summarized in Table 4-8) and Galveston Ring Barrier System (as summarized in Table 4-10), considered driven foundation piles and sheet piles. Suitable piling methods for the installation of driven foundation piles and sheet piles shall be carefully selected. Appropriate equipment (hammer type, energy rate) shall be applied to minimize the level of seabed vibration caused by dissipated hammer energy within foundation soils during the construction of the CSRMs features, including Surge Barrier and Galveston Ring Barrier System. Suitable sheet piling methods shall consider direct-push type utilizing the reaction from a line

of adjacent sheet piles with the driving equipment on top of these adjacent sheet piles (i.e., no vibration). Driving of foundation driven piles and Sheet piling shall be investigated for the feasibility of reaching the design depths. Application of low displacement pile types like sheet piles and circular pipe piles installing with a combination of vibratory-hammers and impact-hammers is considered as a feasible engineering option with the minimal environmental impact on marine mammals and sea turtles for the construction of deep foundation system for the CSRMs features. Additional soil investigation shall be performed along the alignments of the subject CSRMs features to determine the hammer type and energy rating during PED. Vibration monitoring shall be performed during the construction phase to ensure the level of vibration within the allowable limits. Installing air bubble curtains along the perimeter of the underwater pile driving hammer will minimize the underwater sounds effect to marine mammals and sea turtles.

The preliminary level pile drivability assessment was conducted based on the available geotechnical data along the Galveston Harbor Entrance Channel for the Surge Barrier alignment. The evaluation summary is as follows: The proposed sheet piles for the sector gate artificial islands are to be installed to the sheet pile tip elevation of -140 feet. CSRMs foundation piles' design tip elevations may be below -150 feet (MLLW). No substantive level of foundation soil vibration will be anticipated during sheet pile driving or installation between elevation +14 and -55 feet (MLLW). Relatively low level of foundation soil vibration during sheet pile driving between elevation -55 and -105 feet (MLLW) will be anticipated. Ground vibration may be expected for the chosen pile and hammer type within very dense granular soils encountered below elevation -150 feet (MLLW). Therefore, the recommendations mentioned above shall be followed during the PED phase to minimize the underwater sound effects on marine mammals and sea turtles. Further coordination will occur with Environmental during the development of construction documents to minimize environmental impacts identified in the EIS.

11.3 **LIMITATIONS IN STRUCTURAL DESIGN**

Surge Barrier Design are based on limited analysis using preliminary engineering data. The limitations of this study required conservative assumptions to be made to capture the overall cost requirements of the study

As the projects progresses and the details of key design requirements are realized, the proposed structures for the Bolivar Roads crossing and their sill elevations needs to be optimized to deliver the most efficient system possible. During PED additional information and data will be collected, see below for a partial list of the required future investigations.

More extensive soils investigations will need to be conducted during PED to provide a better understanding of the foundation conditions for the various structures along the proposed alignments. A significant pile load test program will be developed during the detailed design phase of this project.

This appendix offers only a preliminary gate opening using empirical formulas listed in USACE EM's. A ship simulation was performed on the current alignment and provided a preliminary location of the Houston Ship Channel Gate complex. However, this simulation was done on a wider single gate opening not with the two-gated complex as recommended in the plan. During PED, a comprehensive physical and numerical model study plan and navigation simulation study will be developed and implemented to finalize the final alignment and required gate opening.

Many of the structural features of this study will require large concrete slabs, walls, etc. that will be considered mass concrete. The feasibility study did not perform a mass concrete analysis, this analysis will be performed during PED in accordance with ETL 1110-2-542 (97) - Thermal Studies of Mass Concrete Structures.

The proposed structures and their respective sill elevation will require a change to the existing geomorphology. This is required to minimize the disruption of the existing tidal prism the new structures will induce. A significant bay bottom sediment modeling program for the proposed changes to the bay bottom cross section will be required during PED. Additional Environmental modeling is required to determine the optimal tidal prism disruption that is both environmentally and economically acceptable. These environmental constrains may dictate changes in gate types and configurations as highlighted in the Gate Design Workshop. During PED, constrains and criteria must be revisited for final determination of the gate complex. It is recommended that PDT should consider a gate design competition during initial phase of the PED for final determination of the gate complex. Each of the I-STORM experts recommended structures that optimize the use of known systems with proven technologies to enhance reliability. There were many general recommendations to improve use of structures with higher closure percentages, including one island onshore, barrier design with no islands (or small piers), new shipping canal through peninsula, and deeper channel for increased ship adaptability. General concerns were:

- i. For both the rising sector gate and the floating sector gate there is a scale problem that has to be solved to make them feasible. The rising sector gate has a width of 2 to 3 times that of the Thames Barrier and might not be possible due to the necessary vertical dimensions. The required strength of the floating sector gate, when spanning the entire shipping lane, is approximately 50% higher than at the Maeslant Barrier and requires heavier ball joints. The construction of such a ball joint might not be possible given the fact that the only factory that has produced them does not exist anymore.
- ii. Division of the shipping lane is necessary for the rising sector gate and maybe also for the floating sector gate which may not be feasible from shipping perspective. Coordination with the Port Authority is needed.

- iii. Not all risks are considered properly. The risk of ship collision is very important especially with the heavy ship traffic and multiple piles or islands in the shipping lane.

A significant portion of the structures required for this project require the driving of piles in marine environments. Impact pile driving in marine environments induce sound levels that have potential negative effects on the ecosystem within the area. Because of the critical marine habitat within the project study area, the study has included the cost of surrounding the foundation being installed with a bubble curtain. There are many factors that contribute to the intensity of the sound levels created during foundation driving, for example, pile type, underlying foundation material, the chosen noise attenuation technique, etc. There will be more detailed study to determine the required pile driving program so that the noise created from the pile driving activities do not exceed federal guidelines.

11.4 **LIMITATIONS IN ANCHORAGE AREA MITIGATION DESIGN**

Due to gate crossing, 45% of current anchorage area will be unusable (Section 4.2.3) which will need to look for alternate anchorage areas. Coast Guard, Pilots and Ships Captains had opinions on locations. USACE has purposed fixed mooring anchors with tugs to guide and align ships. Coast Guard, Pilots and Captains currently are not supportive for the current USACE purposed solution. User requested sites have been evaluated and were not found to be economically viable (e.g., 87M CY initial dredging with regular maintenance will be needed to a proposed site). Cost and Schedule Risk exists until an Anchorage Area and gate crossing alignment can be agreed upon with the Coast Guard. Project schedule could be delayed multiple years, both for USACE and Coast Guard to reach agreement and also for Coast Guard to conduct their own public hearings and approval process for changing anchorage areas. The estimated amount of dredging for USACE proposed anchorage Area is 9,344,000 CY with a 2-year maintenance dredging cycle of 91,830 CY. Currently project costs assume double mooring anchors for each circle for a total of 12 mooring anchors to anchor the bow and stern of a vessel. Estimated cost for a double anchoring system is \$5.1M. It is expected that PDT will revisit this subject during PED phase to model the currents and winds for further refinement in the anchoring system. This is likely a critical path item. Design must be developed to a point that anchorage areas can be purposed/studied and then an agreement must be reached with the Coast Guard.

11.5 **SAN LUIS PASS**

The anticipated risk reduction benefits for protective features at San Luis Pass do not outweigh the potential negative environmental impacts of closing off the last remaining natural pass along the Texas coast. Many of the structures and assets that would be protected as a result of the closure are already elevated above surge heights or are at a ground elevation that limits surge impact.

There is also limited surge risk when factoring in the full probability of potential storm directions. The pass and the adjoining West Bay are very shallow and constitute only 3 to 5 percent (Ref XX) of the

water exchange between West Bay and the larger area of Galveston Bay. The shallow ridge across West Bay (Figure 11-2) provides a natural barrier limiting circulation between West Bay and the larger water body of the Galveston Bay. This condition minimizes the risk of surge being transmitted to the large area of Galveston Bay where there is a greater number of structures and assets at risk from storm surge.



Figure 11-2: West Bay Bathymetry (source)

To evaluate role of San Luis Pass in storm surge propagation along West Bay, twenty synthetic tropical cyclone storms were selected to evaluate storm surge and wave results and make comparisons between existing conditions and with project conditions and with and without San Luis Pass Closed using present-day sea-level conditions. The Coastal Storm Modeling System (CSTORM-MS) was used to provide coupled ADCIRC and STWAVE simulation results for these 20 storms.

Our modeling suggests that San Luis Pass left open, does allow more storm surge water to enter the overall bay system, however, the majority of that water is diffused along Chocolate and West Bays before it reaches significant levels into Galveston Bay. Forerunner water levels can also enter into the bay system, but again, the overall water level in Galveston Bay is not significantly increased. Our modeling showed that even with the San Luis Pass closed off, water levels in the bay could still cause flooding of Galveston Island. Thus, the ring barrier around Galveston Island would still be needed to provide protection and as such, San Luis Pass closure should not be used as an alternative to the proposed Ring Barrier system around Galveston. Figure below (Figure 11-3) illustrates such condition where a powerful CAT 2 storm passes along West of San Luis Pass. Left figure shows the Base condition and the middle figure shows with project condition (Alt A) where San Luis Pass remains open. Poor connectivity between West Bay and Main Galveston Bay is prominent from the middle

figure. We don't see significant increase of surge within the main Bay even with San Luis Pass kept open (Middle figure). The figure on the right shows a condition where the ring barrier has been replaced by a closure at San Luis Pass. We notice that although surge depth has been reduced along West Bay, but Galveston City experiences inundation due to the absence of ring barrier system.

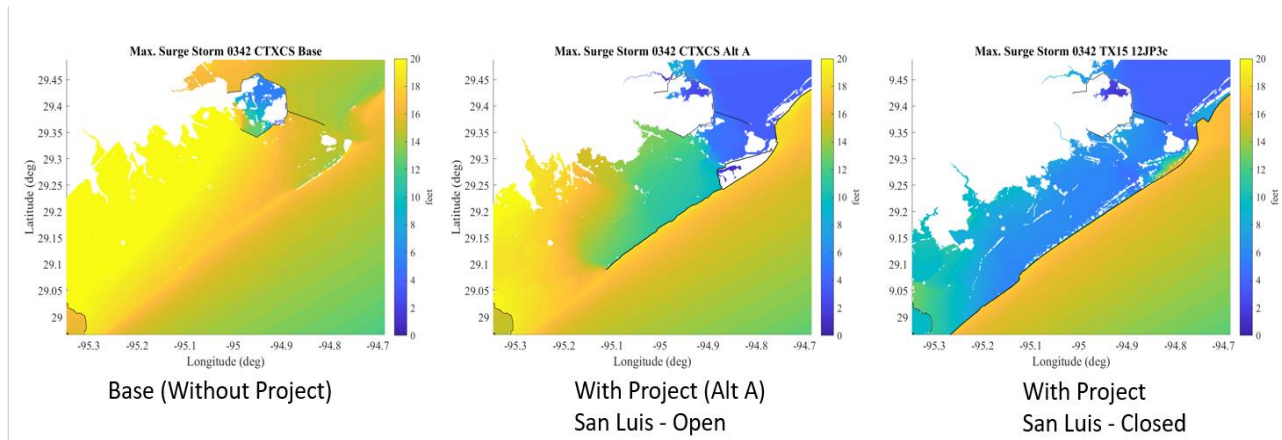

Figure 11-3: Modeling with San Luis Pass

As the San Luis Pass discussion remains outstanding, USACE met with researchers from Center for Texas Beaches and Shores (CTBS) at Texas A&M University at Galveston (TAMUG) on July 03, 2019. Objective was to look at each other's ideas and determine common ground: what is there, science, and rooms for improvements. Main comment from TAMUG researchers was omission of San Luis Pass closure should be examined more closely, as should issues surrounding the modeling of the surge forerunner and selection of the small storm set for evaluating alternatives. The latter should give proper weight to both perspectives of surge generation that are critical for this project, forerunner and peak surge. Both teams recognized that all storms ran with gate completely close. As unfavorable east-west track produced a lot of surge, deep understanding of the gate operation criteria is important.

USACE modeling suggested that with San Luis open and Bolivar close, we can have 1 or 2-foot difference (to be fine-tuned with gate operation criteria) in water surface elevation on the west side of Galveston Bay. TAMUG analyses through modeling and crude economic analyses showed that increases in peak surge within Galveston Bay due to keeping San Luis Pass open could increase cost of damages in many areas. USACE argued that they are addressed through non-structural measures.

11.6 FUTURE OPTIMIZATIONS, ADAPTATIONS & RESILIENCY

During the PED phase, the USACE will continue to refine the engineering design to promote broader resilience, improve climate preparedness, and reduce vulnerabilities through adaptation to climate change. The measures included in the Recommended Plan that can be adapted in the future to climate change. The Bolivar Road Surge Barrier, improvements in sea wall, Clear Lake and Dickinson closure

system are designed high enough that there should not be concern of being impacted by RSLC estimates. However, dune field along Bolivar and West Galveston, levees and flood walls along the GRBS should be constructed in an adaptable or anticipatory manner for estimated sea level rise if possible.

With respect to armoring, as noted in USACE (2012), damage sustained to the levee system during Hurricane Katrina occurred primarily: (1) at transitions between earthen levees and vertical floodwall structures, (2) on the protected side slopes of earthen levees, and (3) near the protected side base of vertical floodwalls. Armoring should be designed to protect from wave and over splash only. There are three major topics related to armoring – leeside fortification of levees to minimize the effects of overtopping, floodside protection of levees from wave attack, leeside protection of floodwalls and levee/wall transition areas.

Leeside armoring of earthen levees and floodwalls shall be designed and constructed to provide resiliency to the system aligned with the guidance provided in ECB 2019-8. As provided therein, a resilient component or system is capable of absorbing energy during loading without experiencing permanent deformation, extensive damage, cumulative degradation or catastrophic failure. Resiliency can be incorporated into a levee by incorporating armoring features on the leeside of the levee. For floodwalls, resiliency can be incorporated via scour/splash pads on the leeside of the floodwalls. An alternatives analysis may be required to be performed to determine the appropriate and cost-effective armoring solution for a given reach of levee or floodwall.

11.6.1 Long Term Exceedance Probability (LTEP)

As per the requirements of ER 1105-2-101, residual risk, which includes consequences of project performance or capacity exceedance, needs to be evaluated and reported for the system as a whole over the system's given life cycle and for each component that makes up that system. In addition to AEP and associated levels of assurance, as an additional metric to assess system performance, Long-Term Exceedance Probability (LTEP) is also provided. LTEP, also referred to as Encounter Probability, is a measure of system performance that establishes the likelihood of exceedance of a given AEP event at least once in the specified duration, and is computed as $1 - (1 - AEP)^N$, where $N = \text{duration/number of years}$. The number of years, N , considered in this report include 10, 20, 30, 50 and 100 years. LTEP for various AEPs and durations/number of years are shown in Figure 11-4. As an example, the red arrows in Figure 11-4 show that the probability of an event with an AEP of 0.01 (i.e. a "100-year event") being equaled or exceeded at least once in a duration of 50 years is 0.4 and once in a duration of 100 years is 0.63. This implies greater chance of occurrences of extreme events as project duration increases. LTEP is also important to define gate operation criteria as it is expected that the surge gate will be operated more frequently at a later stage of the project compare to early stages due to likely exceedance of target elevations due to increase in storm frequency and/or RSLC. This will be explored in PED.

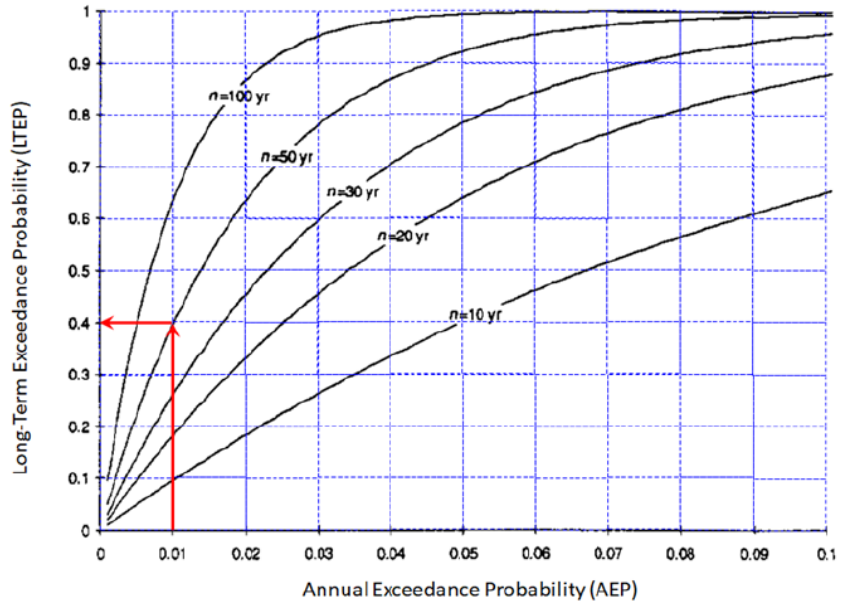

Figure 11-4: Graphical depiction of LTEP and duration/number of years

12.0 CONSTRUCTION SCHEDULE

At the completion of the Feasibility Study, and upon approval by the Chief of Engineers of the United States Army, the Recommended Plan would be provided to Congress for authorization and funding. If authorized and funded by Congress, subsequent phases of the project would include PED, construction, and operations and maintenance. This project lifecycle, showing anticipated durations of each phase, is illustrated in Figure 12-1.

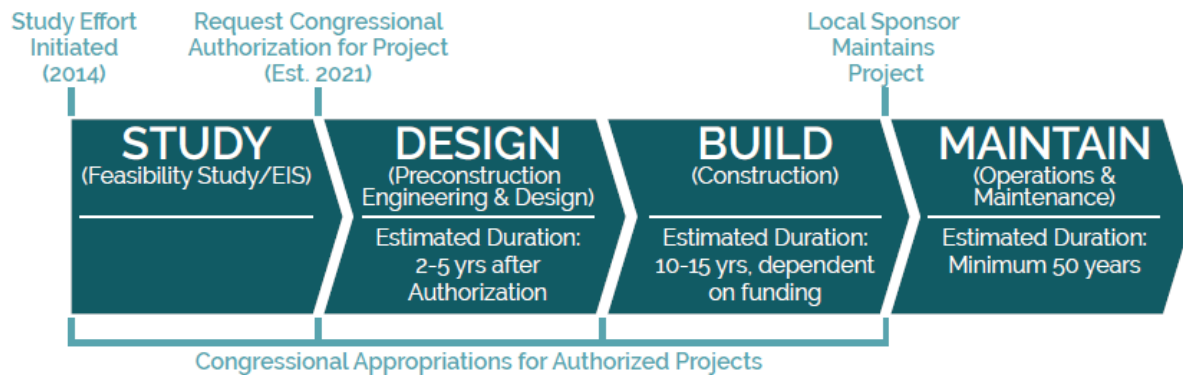

Figure 12-1: Coastal Texas Project Phases

Completion of PED and construction of the Recommended Plan, specifically the pace of construction, is highly dependent on Congressional approval and funding. Assuming an ample funding stream, the Recommended Plan described could be designed and then constructed over a period of 12 to 20 years. Furthermore, construction sequencing will also be dependent on completion of supplemental engineering and environmental studies. Figure 12-2 shows the Gantt Chart with key activities during PED and are described below:

12.1 BOLIVAR ROAD SURGE BARRIER SYSTEM

The Bolivar Roads Gate System is one of the most complex features to design and has one of the longest construction durations. Critical activities, related to the Bolivar Roads Gate system, which are anticipated to occur during PED include, but not limited to:

- Geotechnical investigation
- Detailed Bathymetric and Topographic survey
- Preliminary Design
- Physical Modeling
- Ship Simulation
- Hydrodynamic, wave, and sediment transport modeling, with beach morphology

- Gate Design Completion
- Chanel Realignment, Anchorage, Scour Protection, Navigation Aids
- Gate Operation Criteria & Decision Support System
- Structural Modeling and Design
- Environmental Modeling to satisfy NEPA
- Final Design

20200819	Design	Design	Acq		2022	2023	2024	2025	2026*	2027*	2028	2029	2030	2031	2032	2033	2034	2035 *	2041 *	
Project/Phase	IH/OH	DBB/DB/ECI	Strategy	CWE (\$B)	Q1	Q2	Q3	Q4	Q1	Q2	Q3	Q4	Q1	Q2	Q3	Q4	Q1	Q2	Q3	Q4
Coastal Texas - Surge Gate																				
CTX-SG - Overall Design	OH *	DBB/DB/ECI ?	AE/SATOC?	\$2.10																
CTX-SG - Overall Construction			C/ECI/SATOC?	\$17.10																
Coastal Texas - Bolivar Dunes																				
CTX-BD - Overall Design	IH/OH *	DBB	\$776M A-E MATOC - UR & SB	\$0.17																
CTX-BD - Overall Construction			C/SATOC?	\$1.40																
Coastal Texas - Galveston Dunes																				
CTX-GD - Overall Design	IH/OH *	DBB	\$776M A-E MATOC - UR & SB	\$0.14																
CTX-GD - Overall Construction			C/SATOC?	\$1.10																
Coastal Texas - Galveston Ring Barrier																				
CTX-GD - Overall Design	OH	DBB/DB	\$428M SATOC *	\$0.43																
CTX-GD - Overall Construction			\$78 UR/\$245M SB/\$45M R(a) MATOCS	\$3.60																
Coastal Texas - CCG&PS																				
CTX-GD - Overall Design	OH	DB	\$776M A-E MATOC - UR	\$0.02																
CTX-GD - Overall Construction			\$78 UR MATOC	\$1.90																
Coastal Texas - DGB&PS																				
CTX-GD - Overall Design	OH	DB	\$776M A-E MATOC - UR	\$0.01																
CTX-GD - Overall Construction			\$78 UR MATOC	\$1.29																
Coastal Texas - SPI Beachfill																				
CTX-GD - Overall Design	OH	DBB	\$776M A-E MATOC - SB	0.01 *																
CTX-GD - Overall Construction			C	0.09 *																
Coastal Texas - Mitigation Region 1																				
CTX-GD - Overall Design	OH	DBB	\$776M A-E MATOC - SB	\$0.01																
CTX-GD - Overall Construction			\$245M SB & \$45M R(a) MATOCS	\$0.12																
Coastal Texas - NER Features																				
CTX-GD - Overall Design	OH	DBB	\$776M A-E MATOC - UR & SB	\$0.34																
CTX-GD - Overall Construction			\$78 UR/\$245M SB/\$45M R(a) MATOCS	\$2.80																
Design			Total Design (\$B)	\$3.22																
Procurement			Total Construction (\$B)	\$29.31																
Construction																				
★																				
Asterisks																				
Coastal Texas Surge Gate - Needs to have only 1 A-E DOR and 1 construction contractor - Unknown funding stream - will inform acq strategy																				
Coastal Texas Bolivar and Galveston Dunes - Construction will have to be UR due to sand source being 40 miles offshore. Will need to waive the Jones Act or have 1 contract each beach to make it conducive to Ktrs building dredge capable of performing the work. Will perform H&H in-house to inform the designs of the A-Es																				
Coastal Texas Galveston Ring Barrier - Needs to have 1 A-E DOR.																				
Coastal Texas Clear Creek and Dickinson Nav Gates and Pump Stations - Under 52G, DB RFPs have been running 5%. Little high for the nav gates and pump stations - used 1% - Added 10% to the TPCS construction cost for design																				
Coastal Texas South Padre Island Beachfill - This is total replenishment cost. Will be spaced out over numerous years and will require other acquisitions. Probably C contracts for all of these.																				

Figure 12-2: Gantt Chart (CTXS Design and Construction Schedule)

12.1.1 Concurrent Contracts

Contract 1 is the Bolivar side deep draft navigation gate and center island Station 119+40 to Station 136+40. This contract would include all structural/Geotech/mechanical/electrical and other required work to have the sector gates functioning at contract completion. Order of work would require that the tie-in to the VLG Sill -40 to be completed within a 2-year time to facilitate the issuing of the construction contract for the VLG Sill -40. Dredging and scour protection for the realigned channel are also included. Anticipated construction duration for this contract is 7 years.

Contract 2 is Vertical Lift Gates at Galveston Seawall tie in, Station 158+83 to 169+63. This contract would include all structural/Geotech/mechanical/electrical and other required work to have the vertical lift gates functioning at contract completion. Anticipated construction duration for this contract is 3 years.

Contract 3 is the Combi-wall Station 10+00 to Station 59+66. This contract would include all structural/Geotech and other required work to have the combi-wall completed at contract completion. Anticipated construction duration for this contract is 3 years.

Contract 4 is the Shallow Water Environmental Gates Station 59+66 to Station 77+76. This contract would include all structural/Geotech/mechanical/electrical and other required work to have the shallow water environmental gates functioning at contract completion. Anticipated construction duration for this contract is 3 years.

Contract 5 is Vertical Lift Gates Station 77+76 to 96+48. This contract would include all structural/Geotech/mechanical/electrical and other required work to have the vertical lift gates functioning at contract completion. Anticipated construction duration for this contract is 3 years.

Contract 6 would start at year 3 when contracts 2,3,4 and 5 are complete and contract 1 is still progressing forward. Contract 6 would be the Vertical Lift Gate Sill elevation -40 and small vessel sector gate from Station 96+48 to Station 119+40. This contract would include all structural/Geotech/mechanical/electrical and other required work to have the vertical lift gates and navigation sector gates functioning at contract completion. Anticipated construction duration for this contract is 4 years.

Contract 7 would start at year 7 when contracts 1 and 6 are complete. Contract 7 would be the Galveston side deep draft navigation gate, small vessel navigation sector gate and Vertical Lift Gate sill elevation -40 Station 136+40 to Station 158+83 This contract would include all structural/Geotech/mechanical/electrical and other required work to have the sector gates functioning at contract completion. Dredging and scour protection for the realigned channel are also included. Anticipated construction duration for this contract is 5 years.

12.2 **ER, BEACH AND DUNE SYSTEM**

Due the critical need to prevent further degradation of the barrier islands, the remaining Gulf defense features (and the ER features that support them) are recommended to be designed and constructed first while final design for the Bolivar Roads Gate System is being completed. This would ensure that the Bolivar Roads closure would have an established tie in point when the construction activities are ready to begin on the Bolivar Roads Gate System. The initial focus will be on designing and constructing the 43 miles of beach and dune improvements on Bolivar Peninsula and West Galveston Island. Initial contracts should focus on the dune segments on Bolivar Peninsula near the proposed levee tie-in, north of the Bolivar Roads Jetty System. From that point, the design and construction sequence should expand outward to ensure that changes in the future landscape over the 10 to 15-year construction period would not impact the design of the large gate system. Key considerations, related to the Bolivar and West Galveston Beach and Dune System, to be evaluated during PED include:

- Hydrologic and hydraulic modeling
- Refinement of Alignment considering Real Estate
- Final Design and Construction Template
- Detailed Survey
- Development of the Drainage Plan
- Identification of sediment sources
- Completion of Tier Two environmental document

ER features that provide resilience to the recently constructed beach and dune features should also be designed and constructed in the initial years. This would allow dredging contracts to be linked to the beach and dune and other similar ER features. The study team has already identified nearshore and offshore sediment sources that could be linked to the initial construction contracts. There are also opportunities to source material from upcoming dredging associated with the recently authorized Houston Ship Channel Expansion Channel Improvement Project, or similar future efforts. As part of the Houston Ship Channel Feasibility Study, the USACE and the Port of Houston Authority developed a Dredged Material Management Plan that estimated over 300 million cubic yards of shoaling material would have to be dredged over the 50-year life of the project. Part of the PED process would be to investigate what material may be used beneficially to support construction of the ER and beach and dune features proposed in the Recommended Plan.

Other features along the Texas Coast, such as the remaining ER features outside of the upper coast, or the SPI Beach Nourishment and Sediment Management feature, should be constructed as soon as final designs are completed. These features will also have full environmental clearance at the time of the signed Chief's Report in 2021.

12.3 **GALVESTON RING BARRIER AND SEAWALL IMPROVEMENT**

The design and construction of the GRBS, Seawall improvement, and the two surge gates at Clear Lake and Dickinson Bay are recommended to be linked to the estimated completion date of the Bolivar Roads Gate System. Given that the final design of these features are impacted by the overtopping rates of the dune features, and also on changes in relative sea level rise over the next 10 to 15 years, these features should be adaptable based on the final design of the Gulf defense features. Critical activities to be conducted for these features during PED include:

- Design refinement and optimization.
- Detailed Survey
- Drainage study

12.3.1 Concurrent Contracts (GRBS)

A total of 8 contracts for the GRBS. All contracts are assumed to be able to be concurrent with all of the rest of the contracts. Critical path is pump station construction currently assumed to be 7 yr duration assuming all other contracts are concurrent.

Contract 1: Reach is from the Seawall to Offatts Bayou. This is 14,400 lf of flood wall including 7 vehicle/access gates and 3 gravity drainage structures. Assuming 4yr construction schedule.

Contract 2: Reach is Offatts Bayou combi wall. This is 6,500 lf of combi wall and shallow water environmental gates. This does not include the navigation sector gates. Assuming 5yr construction schedule.

Contract 3: Reach is I 45 to the Port of Galveston property. This reach includes the sewage treatment plant. This is 21,800 lf of floodwall including 11 rail/vehicle access gates and 4 gravity drainage structures. Assuming 5yr construction schedule

Contract 4: Reach is the Port of Galveston property. This reach includes 16,000 lf of floodwall including 20 vehicle/access gates and 5 gravity drainage structures. Assuming 5yr construction schedule

Contract 5: Reach is UTMB to Holiday Drive. This reach includes 3,200 lf of floodwall including 7 vehicle/access gates and 2 gravity drainage structures. Assuming 3yr construction schedule

Contract 6: Reach is Holiday Drive to San Jacinto levee tie into the seawall. This reach includes 4,500 lf of floodwall including 5 vehicle/access gates and 2 gravity drainage structures along with 4,800 lf of levee work. Assuming 4yr construction schedule.

Contract 7: This contract includes all 6 pump stations and drainage mitigation features. Assuming 7yr construction schedule.

Contract 8: This contract includes 2 Offatts Bayou navigation structures, 10,000 lf of offshore breakwater, and 2,000lf Crash Boat Basin channel.

LITERATURE CITED

- Cialone, Mary A., T.C. Massey, Mary E. Anderson, Alison S. Grzegorzewski, Robert E. Jensen, Alan Cialone, David J. Mark, Kimberly C. Pevey, Brittany L. Gunkel, Tate O. McAlpin. 2015. North Atlantic Coast Comprehensive Study (NACCS) Coastal Storm Model Simulations: Waves and Water Levels. ERDC/CHL TR-15-14. U.S. Army Engineering Research and Development Center, Vicksburg, Mississippi.
- Dietrich, J. C., J.J. Westerink, A.B. Kenney, J.M. Smith, R.E. Jensen, M. Zijlema, L. Holthuijsen, C. Dawson, R.A. Luettich, Jr. M. D. Powell, V.J. Cardone, A.T. Cox, and Z. Cobell. 2011. "Hurricane Gustav (2008) waves and storm surge: Hindcast, synoptic analysis, and validation in Southern Louisiana." *Mon. Weather Rev.*, 139(8):2488–2522.
- Dietrich, J. C., S. Bunya, J. J. Westerink, B. A. Ebersole, J. M. Smith, J. H. Atkinson, R. Jensen, D. T. Resio, R. A. Luettich, C. Dawson, V. J. Cardone, A. T. Cox, M. D. Powell, H. J. Westerink, H. J. Roberts. 2010. "A High-Resolution Coupled Riverine Flow, Tide, Wind, Wind Wave, and Storm Surge Model for Southern Louisiana and Mississippi. Part II: Synoptic Description and Analysis of Hurricanes Katrina and Rita." *Mon. Weather Rev.*, 138(2):378–404,
- Ebersole, J., M. Smith, D. Resio, R. Jensen, M. A. Cialone, R. Luettich, C. Dawson, H. J. Roberts, and J. Ratcliff. 2010. A high-resolution coupled riverine flow, tide, wind, wind wave and storm surge model for Southern Louisiana and Mississippi: Part I-Model development and validation. *Monthly Weather Review* 138:345–377.
- FEMA Coastal Counties Report, 2011
- Flather, R. A. 1988. A numerical model investigation of tides and diurnal-period continental shelf waves along Vancouver Island. *Journal of Physical Oceanography* 18, 115–139.
- GCCPRD, 2017
- Hesser, T. J., M.A. Cialone, and M.E. Anderson. 2013. Lake St. Clair: Storm wave and water level modeling. ERDC/CHL TR-13-5. U.S. Army Engineer Research and Development Center, Vicksburg, MS.
- Jensen, R.E., M.A. Cialone, R.S. Chapman, B.A. Ebersole, M.E. Anderson, and L. Thomas. 2012. Lake Michigan: Storm wave and water level modeling. ERDC/CHL TR-12-26. U.S. Army Engineer Research and Development Center, Vicksburg, Mississippi.
- Kalnay, E., M. Kanamitsu, R. Kistler, W. Collins, D. Deaven, L. Gandin, M. Iredell, S. Saha, G. White, J. Wollen, Y. Zhu, M. Chelliah, W. Ebisuzaki, W. Higgins, J. Janowiak, K.C. Mo, C. Ropelewski, J.

- Wang, A. Leetmaa, R. Reynolds, R. Jenne, and D. Joseph. 1996. The NCEP/NCAR 40-year reanalysis project. *BAMS* 77(3):437–472.
- Kinnmark, I.P.E. 1986. The shallow water wave equations: formulation, analysis, and application, Lecture Notes in Engineering, No. 15, SpringerVerlag.
- Kistler, R., E. Kalnay, W. Collins, S. Saha., G. White, J. Woollen, M. Chelliah, W. Ebisuzaki, M. Kanamitsu, V. Kousky, H. van den Dool, R. Jenne, and M. Fiorino. 2001. The NCEP-NCAR 50-year reanalysis: monthly means cd-rom and documentation. *BAMS* 82(2):247–268.
- Kolar, R. L., W.G. Gray, J.J. Westerink, and R.A. Luetlich. 1994. Shallow water modeling in spherical coordinates: Equation formulation, numerical implementation, and application. *Journal of Hydraulic Research* 32 (1):3–24.
- Luetlich, R.A., Jr., J.J. Westerink, and N.W. Scheffner. 1992. ADCIRC: An advanced three-dimensional circulation model for shelves, coasts, and estuaries. Technical Report DRP-92-6, U.S. Army Engineer Research and Development Center, Vicksburg, Mississippi.
- Lynch, D.R., and W.G. Gray. 1979. A wave equation model for finite element tidal computations. *Computers and Fluids*, 7(3):207–228
- Massey, T.C., T.V. Wamsley, and M.A. Cialone. 2011. Coastal Storm Modeling – System Integration. Proceedings of the 2011 Solutions to Coastal Disasters Conference, Anchorage, Alaska, 99-108.
- Massey, T.C., R.E. Jensen, M.A. Bryant, Y. Ding, M.E. Owensby, and N.C. Nadal-Caraballo. 2018. Coastal Texas Protection and Restoration Feasibility Study: Coastal Storm Model Simulations: Waves and Water Levels. ERDC/CHL Technical Report. U.S. Army Engineering Research and Development Center, Vicksburg, Mississippi. In progress.
- McAlpin, J., C. Ross, and J. McKnight. 2018. Draft Coastal Texas Region 1 (CTR1) Estuarine Numerical Modeling Report. ERDC/CHL TR-18-XX. USACE Engineer Research and Development Center, Coastal and Hydraulics Laboratory. Vicksburg, Mississippi. 278 pp.
- Nadal-Caraballo, N.C., A.B. Lewis, V.M. Gonzalez, T.C. Massey, and A.T. Cox. 2018. Coastal Texas Protection and Restoration Feasibility Study: Probabilistic modeling of coastal storm hazards. ERDC/CHL Technical Report. U.S. Army Engineering Research and Development Center, Vicksburg, Mississippi. In progress.
- Paine, J.G., T. Caudle, and J. Andrews. 2014. Shoreline Movement Along the Texas Gulf Coast, 1930s to 2012. Bureau of Economic Geology. August 2014. http://www.beg.utexas.edu/coastal/presentations_reports/gulfShorelineUpdate_2012.pdf.

U.S. Army Corps of Engineers (USACE). 2006. Louisiana Coastal Protection and Restoration (LACPR) Preliminary Technical Report. Provided to United States Congress.

USACE 2016. Coastal Texas Protection and Restoration Study: Relative Sea Level and Climate Change White Paper. Galveston District, USACE. Unpublished Whitepaper.

Westerink, J. J., R.A. Luettich Jr., A.M. Baptista, N.W. Scheffner, and P. Farrar. 1992. Tide and storm surge predictions using finite element model. *Journal of Hydraulic Engineering* 118(10):1373–1390.

Westerink, J.J., R.A. Luettich Jr., J.C. Feyen, J.H. Atkinson, C. Dawson, H.J. Roberts, M.D. Powell, J.P. Dunion, E.J. Kubatko, and H. Portaheri. 2008. A basin- to channel-scale unstructured grid hurricane storm surge model applied to southern Louisiana. *Monthly Weather Review* 136:833–864.

Annex 1

ERDC Spine Morphology Report

Annex 2

Mott MacDonald Hydrology & Hydraulics Report

Annex 3

Mott MacDonald Ring Barrier Overtopping Memo

Annex 4

Mott MacDonald Wave Loading Report

Annex 5:

Mott Macdonald Drainage Analyses Report

Annex 6:

ERDC Larval Transport Report

Annex 7:

Mott Macdonald Pump Station Design Plates

Annex 8:

Mott Macdonald Pump Station Design Criteria Report

Annex 9:

GCCPRD Geotechnical Study Report

Annex 10:

**Mott Macdonald Material Source Investigation
Report**

Annex 11:

Bolivar Dune Mapbook

Annex 12:

Civil Design Plates

Annex 13:

Galveston Dune Mapbook

Annex 14:

ERDC Ship Simulation Report

Annex 15:

Gate Design Workshop Report

Annex 16:

Anchorage Decision MFR

Annex 17:

Galveston Ring Barrier Mapbook

Annex 18:

Beach & Duncce Design and Drainage Report

Annex 19:

Structural Design Plates

Annex 20:

ER Feasibility Plan

Annex 21:

SPI Mapbook

Annex 22:

Cost Estimate

